

"Towards an Earth-Moon Economy - Developing Off-Planet Resources"

Moon Miners' Manifesto

www.MMM-MoonMinersManifesto.com



MMM Classic Themes

Eden on Luna

FORWARD

As both a passionate environmentalist and a passionate believer that mankind's future will be just as rooted in space as it is now on Earth, it is only natural that many of the ideas that have inspired my writings flow from a natural tendency to view the future through both "eyes."

The resulting vision of lunar settlements grounded in firm environmental principles, is evident from the very first article of the first issue of Moon Miners' Manifesto. Indeed, it is this double passion, and the firm belief that "Mother Earth" and "Father Sky" are mates made in heaven, and that every philosophy grounded on one to the exclusion of the other is intrinsically and fatally flawed, that lies behind the choice of the name "Moon Miners' Manifesto."

On the Moon, with no enveloping atmosphere or hydrosphere, we must create mini-biospheres within which to encradle ourselves. With no global ocean to serve as a sink, and with no global atmosphere to carry away our smoke and other gaseous fumes, we will be forced to "live downwind and downstream of ourselves." On Earth, our polluting ways will harm our children and grandchildren whom we self-deceivngly profess to love. We pollute because, in the short term, we can get away with it. On the Moon, pollution of any kind could quickly make any settlement unlivable. We will have no choice but to become the ultimate environmentalists. In the process, Lunans will learn ways to live and develop systems and processes that can be used on Earth, saving the Mother world from itself. Yes, we could learn those things here, but we won't, because we don't have to - we can put it off and let our children worry about it.

In MMM, we will deal with many aspects of learning to live in harmony with nature, with the plants and animals we must bring with us. To do so we will learn new ways of manufacturing, of using, and of disposing of the material goods involved in lunar civilization. These lessons alone are enough to justify lunar settlements. Other benefits will follow.

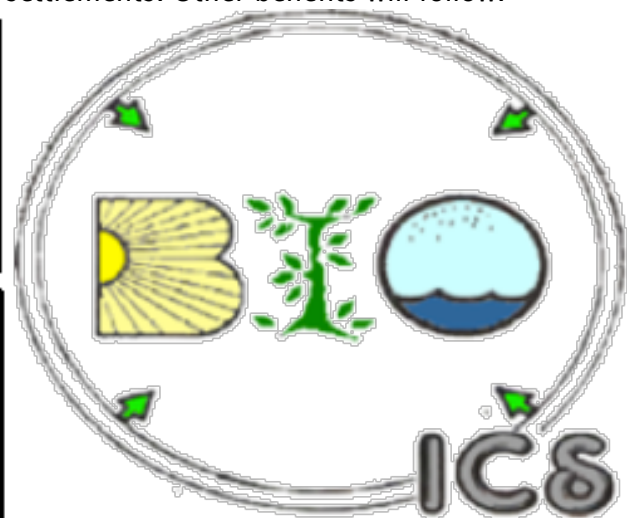
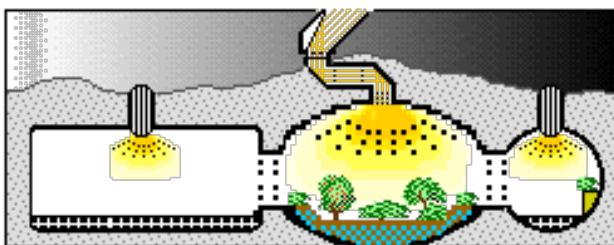

CHRONOLOGICAL INDEX MMM THEMES: EDEN ON LUNA

- MMM # 1 “M is for Mole”
- MMM # 2 MOON GARDEN
- MMM # 4 PAPER CHASE II
- MMM # 5 “M IS FOR MIDDOORS”
- MMM # 7 “M IS FOR MONTH, OR SUNTH”
- MMM # 8 ANIMAL LIFE; Colonists’ Quiz on Animals; Parkway
- MMM # 16 Frontiers Have Rough Edges
- MMM # 22 Hair
- MMM # 23 Tailings
- MMM # 26 Toy Chest; ThermoPlastics
- MMM # 31 Green Earth, Clean Moon
- MMM # 34 Many Space Benefits for Mother Earth; Recycling;The 4th “R”
- MMM # 36 Biospherics Research lags behind Hardware R&D: Biospherics Design Issues
- MMM # 38 Primage: Harvesting volatiles in Moondust; Birth of LUNAX; Polders, A Space Colony Model
- MMM # 39 Saving Money on Food in Space; Moon-Mining & Common Eco-Sense
- MMM # 40 CLOACAL VS. TRITREME PLUMBING
- MMM # 43 Living with the Moon’s own rhythms: Dayspan, Nightspan, Sunth
- MMM # 47 Native Born (on the Moon); Funerals for Space Pioneers
- MMM # 50 Trees on the Space Frontiers
- MMM # 51 Fire Department; Fresh Air
- MMM # 52 Beyond-the-cradle off-Earth settlements (“Xities”); Xititech; Fireside
- MMM # 55 Moon Roofs; Shantytown; Agri-Garments
- MMM # 63 Color the Moon Anything but Gray
- MMM # 63 Flag Concept for Lunar Republic; Reports on Biosphere II; Biosphere III?
- MMM # 65 Stowaway Imports
- MMM # 66 Encyclobin: Letting the Right Hand know what the Left Hand is “bydoing”
- MMM # 67 Making the Most out of Water Reserves; Settlement Water Company;
Xeroprocess: Minimizing the use of water in industrial operations
- MMM # 68 Cornucopia Crops: Key Crops serving many uses
- MMM # 69 Seven Wonders of the Moon
- MMM # 74 Visual Access to the Outside; Sun Moods: letting the Sun Inside
- MMM # 77 Art du Jour: temporary art from food stuffs
- MMM # 80 Paint Media derived from Moondust
- MMM # 90 Good Housekeeping depends on Site Management
- MMM # 94 Desolation Offers Natural Quarantine
- MMM # 95 Earth & Moon: 2 Types of “Cradle Blanket”
- MMM # 96 Vigilance for Fresh Air; A Green Security Blanket
- MMM # 97 Frontier Biospherics; Effects of Lunar Environment on Spirituality;
“Greening the Gray” Anthem for Lunan Pioneers
- MMM # 102 Footsteps & Other Leavings; Archive Luna
- MMM # 104 Plant Only Diets for the Frontier
- MMM # 109 Luna City Streets
- MMM # 110 “Reclamation” is a Xity’s Charter Function
- MMM # 116 A Modular Approach to Biospherics
- MMM # 131 The Settlement as an Intentional Community; Spinning up Frontier Enterprises
profitable for both Earth and Space
- MMM # 137 Taking Back the Surface: Above Surface Architectures for Moon and Mars Habitats

- MMM # 138 Coping with “Black Sky Country”
- MMM # 145 The Independent Lunan Farmer
- MMM # 148 “EARTHPATCH” – Anchoring Lunan and Martian Homesteads
- MMM # 149 Homestead Gardens & Early Cottage Industries
- MMM # 150 “At Home” on the Moon: No Longer Treating the Moon as “Alien”; Learning not to fear the night; Loving Moondust: Domesticating Regolith; Embracing the Moon’s Rhythms: Adopting a Moon Calendar
- MMM # 150 at home on the Moon; learning not to fear the night; loving moondust; rhythms/ calendar;
- MMM # 151 Engaging the Surface with Moonsuits; Could we be “at Home” without Pets and Wildlife?
- MMM # 152 Homes “at home” on the Moon: Being “at Home” is Completed by being able to go “Outside”; Security Comfort Levels
- MMM # 154 Homestead Ambience: waterfalls and fountains; Nitrogen and the Moon's Future
- MMM # 158 Farming on the Moon
- MMM # 160 Will Settlement Change The Moon’s Appearance?
- MMM # 164 Agriculture on the Moon: “Seasonal Crops” Year Around; The Seasons of Luna City
- MMM # 165 Settlement Garden Tours: A Favorite Frontier Pastime
- MMM # 175 Creating “Nature Walks” on the Moon
- MMM # 176 National Parks on the Moon
- MMM # 179 Trashure Creativity & “Wasourcefulness”: Two Critical Talents on the Space Frontier
- MMM # 199 The Moon as Virgin Territory, “a world without a history”
- MMM # 201 Beyond Our First Moonbase: Future of Human Presence on the Moon; Modular Biospherics: Making the most of pressurized pedestrian & vehicular corridors: “Living Wall Systems”
- MMM # 202 Modular Biospherics: Middoor Public Spaces ideal for added vegetation and “urban” wildlife
- MMM # 204 Modular Biospherics: Toilet–equipped Habitat and Activity Modules; Lunar Zen Gardens: blending interior and Exterior spaces
- MMM # 206 Modular Biospherics IV odd Production with Diversity
- MMM # 214 The “Planet Earth & Space” Conference Proposal
- MMM # 215 Taking the Green Spirit to the Moon; Lunan Pioneers will turn their Gray World Green
- MMM # Why Lunan Pioneers will turn their Gray World into a “Green” Sanctuary
- MMM # 219 Using the Green Movement to Advance Technologies Needed on the Lunar Frontier;
- ANNEX “Mother Earth” & “Father Sky” – The Duality of the Human Environment;
Starting a Dialog Between the Environmental & Space Communities
- BONUS SECTION: The Luna City Yellow Pages (pdf page images)
- MMM # 164 (no one topic)
 - MMM # 165 Nightspan services,
 - MMM # 166 Arts & Crafts, Recycling
 - MMM # 167 Work Vacation Contractors
 - MMM # 231 Help Wanted Section

About the Above Selection of Articles From the editor

Perhaps some of you may notice that the relevance of the articles above to how lunar pioneers will live on the Moon in a way that embodies the best of environmental principles has two main threads:

(1) Living downwind and downstream of ourselves:

Life in a restricted enclosed mini–biosphere with minimal air and water “sinks” will allow little room for careless behavior of the kind exhibited by even the most environmentally attuned terrestrials. The pioneers will of necessity have living in harmony within their

“pockets” of “nature” foremost in mind, even above personal economics and comfort and convenience. The young will of necessity be taught these facts of life. Living accordingly secures their future as well.

(2) Using resources with maximum efficiency:

This will be necessary if they are going to beat the odds against achieving economic self-reliance. This does not mean the ability to produce all their needs. It means being able to produce enough of their own needs to significantly reduce the burden of very high cost imports, as well as being able to export enough to earn credits to pay for imports that cannot be avoided. Using lunar resources sparingly will involve industrial design standards that permits thorough recycling and avoiding cross contamination of unlike materials by adhesives and other disassembly-unfriendly methods.

Our hope it that the Pro-space reader will now become more environmentally aware, and that conversely, that the pro-environment reader will become more enlightened about the prospect for the ultimate in clean-green living on the Moon. Luna pioneers will teach us down here the way.

It is a shame, that in general, environmentalists and space enthusiasts seem to be in two opposing armed camps. The truth is that **we all want the same thing: preservation of Mother Earth and of Humanity.** We just come at this goal from different directions. We owe it to ourselves, both parties, to find ways to collaborate and strengthen each other’s activities and projects, and end the petty jabs.

SUB-THREAD INDEX: MMM THEMES: EDEN ON LUNA

There must be many valid ways to divide these many articles into sub-threads, and “sub-sub” threads. The Editor hopes you will find the following “clusters” helpful in understanding the surprisingly generous opportunities for pioneers to settle the Moon, to make themselves at home, and live happy and productive lives – in a setting that most see as quite forbidding. – Peter Kokh kokhmmm@aol.com

Living in the Stark, Sterile Lunar Environment

MMM # 1 “M is for Mole”

MMM # 16 Frontiers Have Rough Edges

MMM # 39 Moon-Mining & Common Eco-Sense

MMM # 47 Native Born (on the Moon)

MMM # 69 Seven Wonders of the Moon

MMM # 74 Visual Access to the Outside; Sun Moods: letting the Sun Inside

MMM # 90 Good Housekeeping depends on Site Management

MMM # 94 Desolation Offers Natural Quarantine

MMM # 95 Earth & Moon: 2 Types of “Cradle Blanket”

MMM # 102 Footsteps & Other Leavings

MMM # 137 Taking Back the Surface: Above Surface Architectures for Moon and Mars Habitats

MMM # 138 Coping with “Black Sky Country”

MMM # 150 “At Home” on the Moon: No Longer Treating the Moon as “Alien”; Learning not to fear the night; Loving Moondust: Domesticating Regolith; Embracing the Moon’s Rhythms: Adopting a Moon Calendar

MMM # 151 Engaging the Surface with Moonsuits

MMM # 152 Homes “at home” on the Moon: Being “at Home” is Completed by being able to go “Outside”; Security Comfort Levels

MMM # 154 Nitrogen and the Moon’s Future

MMM # 160 Will Settlement Change The Moon’s Appearance?

MMM # 175 Creating “Nature Walks” on the Moon

MMM # 176 National Parks on the Moon
MMM # 199 The Moon as Virgin Territory, "a world without a history"
MMM # 201 Beyond Our First Moonbase: Future of Human Presence on the Moon
MMM # 230 McMurdo Sound Station as a Preview of Lunar Settlement?
MMM # 235 More than one Settlement needed to open Moon
MMM #257 The Critical Path to "Pioneering the Moon": The Role of "Lee-Vac" and "Out-Vac" Activities
ANNEX "Mother Earth" & "Father Sky" – The Duality of the Human Environment;
Starting a Dialog Between the Environmental & Space Communities

Lunar Lifestyles to fit Lunar Rhythms

MMM # 7 "M IS FOR MONTH, OR SUNTH"
MMM # 43 Living with the Moon's own rhythms: Dayspan, Nightspan, Sunth
MMM # 150 "At Home" on the Moon: Learning not to fear the night; Embracing the Moon's Rhythms: Adopting a Moon Calendar
MMM # 164 Seasonal Crops" Year Around; The Seasons of Luna City

Closed Settlement Mini-Biospheres & The "Middoors"

MMM # 5 "M IS FOR MIDDOORS"
MMM # 36 Biospherics Research lags behind Hardware R&D: Biospherics Design Issues
MMM # 38 Polders, A Space Colony Model
MMM # 40 CLOACAL VS. TRITREME PLUMBING
MMM # 50 Trees on the Space Frontiers
MMM # 51 Fire Department; Fresh Air
MMM # 52 Beyond-the-cradle off-Earth settlements ("Xities"); Xititech
MMM # 63 Flag Concept for Lunar Republic; Reports on Biosphere II; Biosphere III?
MMM # 67 Making the Most out of Water Reserves; Settlement Water Company;
Xeroproccess: Minimizing the use of water in industrial operations
MMM # 96 Vigilance for Fresh Air
MMM # 96 A Green Security Blanket
MMM # 97 Frontier Biospherics; Effects of Lunar Environment on Spirituality;
"Greening the Gray" Anthem for Lunan Pioneers
MMM # 109 Luna City Streets
MMM # 110 "Reclamation" is a Xity's Charter Function
MMM # 116 A Modular Approach to Biospherics
MMM # 131 The Settlement as an Intentional Community
MMM # 151 Could we be "at Home" with out Pets and Wildlife?
MMM # 164 Seasonal Crops" Year Around; The Seasons of Luna City
MMM # 201 Modular Biospherics: Making the most of pressurized pedestrian & vehicular corridors:
"Living Wall" Systems
MMM # 202 Modular Biospherics: Middoor Public Spaces ideal for added vegetation and "urban" wildlife
MMM # 204 Modular Biospherics: Toilet-equipped Habitat and Activity Modules;
Lunar Zen Gardens: blending interior and Exterior spaces
MMM # 206 Modular Biospherics IV odd Production with Diversity
MMM # 215 Taking the Green Spirit to the Moon; Lunan Pioneers will turn their Gray World Green
MMM # 219 Using the Green Movement to Advance Technologies Needed on the Lunar Frontier

MMM # 257 The Critical Path to "Pioneering the Moon": Incorporating an Earth-like "Outdoors" in Middoor Spaces

Agriculture & Homestead Gardening

MMM # 2 MOON GARDEN
MMM # 8 ANIMAL LIFE; Colonists' Quiz on Animals; Parkway
MMM # 38 Birth of LUNAX
MMM # 39 Saving Money on Food in Space
MMM # 50 Trees on the Space Frontiers
MMM # 55 Agri-Garments
MMM # 68 Cornucopia Crops: Key Crops serving many uses
MMM # 104 Plant Only Diets for the Frontier
MMM # 145 The Independent Lunan Farmer
MMM # 148 "EARTHPATCH" – Anchoring Lunan and Martian Homesteads
MMM # 149 Homestead Gardens & Early Cottage Industries
MMM # 154 Homestead Ambience: waterfalls and fountains
MMM # 158 Farming on the Moon
MMM # 164 Agriculture on the Moon: "Seasonal Crops" Year Around; The Seasons of Luna City
MMM # 165 Settlement Garden Tours: A Favorite Frontier Pastime

Private Enterprise and Cottage Industry Opportunities: Scarce Volatiles, Garden Products, Arts & Crafts Recycling, "Waysource"fullness

MMM #4 PAPER CHASE II
MMM #6 "M" is for Missing Volatiles: Methane and 'Mmonia; Mars, PHOBOS, Deim
MMM # 22 Hair
MMM # 23 Tailings
MMM # 26 Toy Chest; ThermoPlastics
MMM # 34 Recycling; The 4th "R"
MMM # 38 Primage: Harvesting volatiles in Moondust
MMM # 47 Funerals for Space Pioneers
MMM # 52 Fireside
MMM # 55 Moon Roofs; Shantytown
MMM # 63 Color the Moon Anything but Gray
MMM # 65 Stowaway Imports
MMM # 66 Encyclobin: Letting the Right Hand know what the Left Hand is "bydoing"
MMM # 77 Art du Jour: temporary art from food stuffs
MMM # 80 Paint Media derived from Moondust
MMM # 131 Spinning up Frontier Enterprises profitable for both Earth and Space
MMM # 179 Trashure Creativity & "Wasourcefulness": Two Critical Talents on the Space Frontier
MMM #257 The Critical Path to "Pioneering the Moon": The Role of Indigenous Arts & Crafts

Exporting Lessons Learned to those on "Mother Earth"

MMM # 31 Green Earth, Clean Moon
MMM # 34 Many Space Benefits for Mother Earth
MMM # 214 The "Planet Earth & Space" Conference Proposal

Bonus Selection from the Luna City Yellow Pages

MMM # 164
MMM # 165 Nightspan services,

MMM # 166 Arts & Crafts, Recycling
MMM # 167 Work Vacation Contractors
MMM # 231: Help Wanted Section

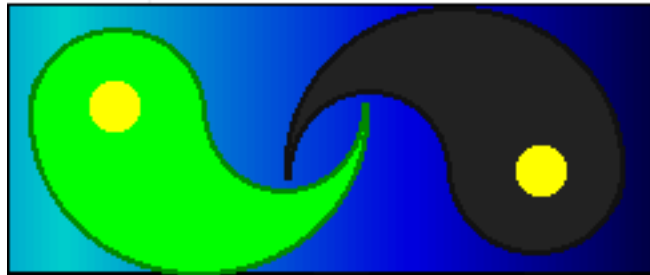

MMM # 1 December 1986

"M" IS FOR "MOLE"

By Peter Kokh kokhmmm@aol.com

Forward: There follows the introductory and only essay article in the first issue of Moon Miners Manifesto, dated December 1986, shortly after the founding in Milwaukee of what was then the Milwaukee Lunar Reclamation Society L5, a chapter of the L5 Society advocating settlements in space after the inspiration of Gerard K. O'Neill.

This piece is about the historical roots of the inspiration behind MMM. Herein lies the personal "eureka" that gave birth to the brainstorming chain of thought that continues throughout many articles in MMM through the present. It explains the third "M", "the Manifesto". For while many readers refer to MMM simply as "Moon Miners", to Peter Kokh, the emphasis has always been on the third M. To Kokh, this newsletter has always been "The Manifesto".

"M" is for "mole", which is what many people, even some prominent space advocates, think settlers of the Moon are going to be. Yes, lunar habitats and facilities will be covered by some 2-4 meters (6-13 feet) of lunar soil or "regolith." But, while such a shielding overburden is necessary for long-term protection from cosmic rays, solar flare outbursts, and the sun's ultraviolet rays, this does not mean that we "moon miners" can't take the glory and warmth of sunshine down below with us!

A year ago this last Spring [May, 1985], in following up on an ad in The Milwaukee Journal's Sunday Home Section, I went to see a marvelous place called "TerraLuxe" ["Earth Light"] in the Holy Hill area about twenty miles northwest of Milwaukee. Here, architect-builder Gerald Keller (appropriately, German for "cellar") had built a most unusual earth-sheltered or underground home.

Run-of-the-mill underground homes are covered by earth above and to the west, the north, and the east, while being open and exposed to the sun along the south through a long window wall. But Mr. Keller's large home (some 8,000 square feet) was totally underground except for the north-facing garage door. Yet the house was absolutely awash in sunlight, more so than any conventional aboveground house I had ever seen. Sunlight poured in through yard wide circular shafts spaced periodically through main room ceilings. These shafts were tiled with one inch wide mirror strips. Above on the surface, an angled cowl, also mirrored on the inside, followed the sun across the sky from sunup to sundown at the bidding of a computer program named "George" (undoubtedly of "let-George-do-it" fame).

Even more amazingly, through an ingenious application of the periscope principle on the scale of picture windows, in every direction you could look straight ahead out onto the

surrounding countryside, even though you were eight feet underground. I felt far less shut in than in my own Milwaukee bungalow.

TerraLuxe was built as an idea house and my tour cost \$4. This home would make an ideal group field trip tour, but unfortunately, some visitor found it too irresistible, and it is now privately owned. Of course, Mr. Keller's ingenious ideas to bring down below both sunshine and the view, would have to be adapted to lunar building conditions. But I have no doubt that they could be. Mr. Keller told me that he had drawn up plans and blueprints for a whole city using his principles. Someday, I'd like to see them. If the streets and byways of his city were similarly built*** in a sun-drenched pressurized underground conduit, so one could leave one's lunar home and go anywhere throughout the settlement without putting on a spacesuit, why, it'd be better than living in the Milwaukee I love! – Peter Kokh, November 1986.



Photo of Exterior of TerraLuxe

The photo above was taken the morning of October 15, 2002, more than 17 years later. Visible are the exterior panes of a trio of periscopic picture windows, and several modified skylights. The originals had mirrored cowls which followed the sun across the sky, resetting their position each night. There may have been subsequent problems with the "heliostat" seals or the mechanical apparatus, or computer controls, as these sun-following mirrored hoods have long since been replaced by fixed bubble dome covers. More than eight feet of soil covers the home.

Location of TerraLuxe

MapQuest.com detail for 4631 Sonseeahray Dr., Hubertus (Washington County), WI puts the red star, indicating property location, towards the NW end of Sonseeahray Drive. It is actually located at the SE end of the drive, being the first property on the left as you enter off Hubertus Road.

For the National Space Society's 1998 International Space Development Conference, held in Milwaukee that year, produced a table-top model of a modular lunar homestead incorporating these "one with nature" features that could make underground living on the Moon much more satisfying.



Diagram of model above at http://www.moonsociety.org/chapters/milwaukee/mmm/moonmanor_plan.gif

This article is online at: http://www.moonsociety.org/chapters/milwaukee/mmm/mmm_1.html

The illustrations below show how these 2 Terra Lux innovations could be adapted for lunar use.

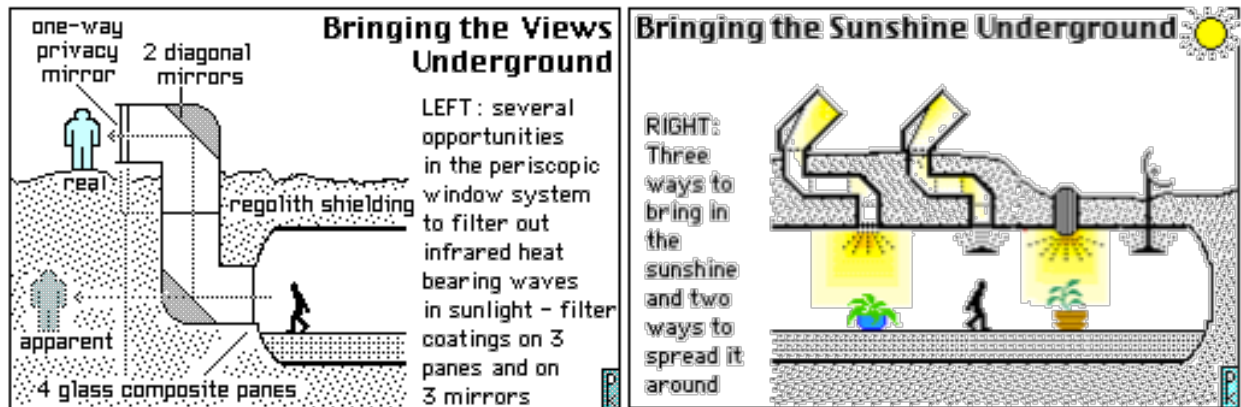

MMM # 2 February 1987

MOON GARDEN

MOON GARDEN By Peter Kokh kokhmmm@aol.com

[First of a series of articles on the need to predevelop the software of Lunar Civilization]

Yes, the air and water of a Lunar settlement can be chemically recycled; and yes, the settlers can be fed synthetic foods so that it would not be strictly necessary to bring to the Moon any representatives of other living Earth species, plant or animal. However, most of us, would hardly find this conducive to morale on a lifetime basis. A settlement of colonists chosen for their indifference to the "real thing" could hardly be called "human."

Whether we think of it or not, human beings cannot be divorced from the rest of Earth life amongst which we have evolved not only biologically and physiologically but culturally as well. True, many persons live in homes and apartments that seem almost antiseptic, but Nature is just outdoors. On the Moon there is no world of living nature just outdoors, and colonists will most certainly feel compelled to go overboard in compensating for the Lunar sterility and barrenness by living in homes (i.e. not mere modules) that are lush with greenery, vivid with floral color, and sonorous with bird song.

Now the Lunar dayspan-nightspan cycle is twenty-nine and a half times as long as our day-night cycle; this presents a problem for Lunar gardening. True, a solar power satellite at L1 or some other amply sized power unit (e.g. nuclear) might allow colonists to cycle light and darkness to their gardens on an artificial 24 hr schedule. True, colonists themselves will live and work on such a schedule and illuminate their homes accordingly. But on the one hand, it is foolish to assume that energy available will always allow such lavishly inefficient usage.

On the other hand, once the beachhead base and its modules are outgrown and the first genuine Lunar homes are built on-site from building components produced from the lunar regolith, it is likely that these homes will have some sort of atrium floor plan centered around a solarium-garden flooded with sunlight captured by a heliostat and channeled perhaps along an indirect shielded route. (Glass, but not quartz, filters out ultra-violet). In such a garden, probably a combination of decorative and fruit and vegetable varieties, natural lunar cycling will be the ideal, efficiently using available energy, and avoiding excess heat buildup. We're not ready.

Should NASA spend precious dollars needed elsewhere to pay some mercenary to develop Moon-hardy floral and vegetable varieties? NO! It is rather up to those of us who would go there or prepare the way for others to someday acculturate themselves to satisfying lunar living, to experiment at our own expense to discover the hardiest varieties now around vis-à-vis length

of the day-night cycle and keep breeding them until we have a Burpees- Luna Catalogue full of Moon-hardy varieties to grace Lunar homes and provide Lunar settlers with the same feeling of being cradled by Mother Nature -- despite the stark and harsh Lunar "outlooks" -- that we at home have grown up with here on our bounteous Earth.

Now finding plants that will thrive on fourteen and three quarters dates of continuous sunshine will surely be a lot easier than finding those that can shutdown, if you will, for an equal period of darkness, with the least need for punctuation by sessions under grow lights. But the closer we approach the ideal of natural Lunar cycling, the more efficiently will the colony be able to use available energy, and the more autonomously would the gardens maintain themselves. All of this holds true of the Lunar farms that will raise the major crops and staples as well.

Ideal will be the crops that can germinate and sprout in the warm, moist darkness and then sprint to maturity during the two week period during which they will receive more than a month's worth of sunshine by Earth standards. Next in desirability will be crops that mature by the end of the second sun-flooded period.

On Earth, garden flowers fall into two broad categories: annuals which bloom all season but have to be replanted every year, and perennials which bloom briefly but come back of themselves year after year. On the moon, the breeding ideal will be the plant that blooms every sun period or perhaps every other, and coasts through the sunless period without dying back.

It will take years of breeding work by many experimenters to develop the kind of Moon-hardy plants we have briefly described. But it is a work that, at least in its beginning stages, can be done by knowledgeable laymen. Creation of artificial Lunar-like growing cycles indoors is a simple matter and does not require expensive high-tech methods. Time well spent is the key.

So even if Congress were to provide NASA and Space Studies Institute [SSI] chemists and engineers with all the funding they could possibly use so that hard-ware for a return to the Moon were ready in five years, the effort would be doomed to failure. For it will take a lot more than hardware and chemical engineering to make a Moon settlement a success. There is so much more to human civilization than that.

The work needed to predevelop an ample repertoire of suitable plants will continue to be neglected unless it is done by such as us in the heretofore "cheering section." We commoners must roll up our sleeves. If fans of the space movement remain just that, content to send in donations, write their congressmen, and make phone calls, nothing will be accomplished. We must not be lulled into believing that this is the most we can contribute to the realization of our dream of the extension of the the human realm beyond the traditional range of the Earth's surface.

Meanwhile those of you who fancy your-selves possessing a green thumb, take this as a call to arms. If enough of us were to do Lunar homework in this and other needed areas it might be possible to network our efforts through some such vehicle as "The Mother Moon News". Why not? *

[To learn more about the MiSST and LUNAX experimental lunar agriculture efforts that followed in the early 1990s, go to <http://www.moonsociety.org/chapters/milwaukee/lunax/>

MMM # 4 April 1987

PAPER CHASE

Paper Chase II

[Third in a series of articles on the need to pre-develop the SOFTWARE of a Lunar Civilization]

By Peter Kokh kokhmmm@aol.com

On Earth with its vast atmosphere, oceans, and still extensive forests, we can arguably afford to withdraw such organic ingredients as hydrogen and carbon from the environmental cycle in the form of paper, plastics, etc. After all, Nature has been doing the same thing, "banking" these elements for geologically long times as coal, oil, and gas.

On the Moon the situation is quite different. Hydrogen and carbon do exist in amounts worth scavenging in the upper layers of Lunar soil, put there by the incessant solar wind. From Apollo samples we might expect every thousand tons of soil processed to yield (besides over 400 tons of oxygen) one ton of hydrogen, 230 lbs. of carbon, and even 164 lbs. of nitrogen (source: Stuart Ross Taylor. Planetary Science: A Lunar Perspective. Lunar and Planetary Institute, 1992, p 159). This is hardly abundance. Polar permashade fields certainly must be searched, but this scenario requires that the Moon's axis will not have shifted more than a degree or so in the past 3.5 billion years: a tall order. If any ices of water or carbon oxides are found there, they will certainly be needed to expand the biomass of the colony. Withdrawal and banking will still be quite out of the question. Hydrogen and carbon for non-biological uses will still be priced as "import elements."

[The above was written in 1987, eleven years before Lunar Prospector confirmed the existence of ice deposits at both poles. Yet the caution remains. Even billions of tons of hydrogen, carbon, and nitrogen (presuming that the ice contains carbon and nitrogen oxide ices as well, which one might expect if the source is comet impacts) -- even so much is not enough to support (a) lunar biosphere(s) if the population on the Moon grows to a considerable size. A conservative approach is still the best strategy, if we are not to stunt the growth of lunar development. -Ed.]

Paper is basically cellulose, a carbohydrate, half hydrogen & carbon, half oxygen. Its production in modern forms is very taxing on environmental air and water. While this may be a justifiable tradeoff on the bounteous Earth, the toxic burden of its production would soon overwhelm the very limited environments of Lunar (or in-space) settlements even if "waste papers" were recycled 100% (which would necessitate brainwashing all would-be settlers.) Luna City (and "New Tucson" at L5 as well) must be a paperless society. Throwaway addicts will argue this, of course, but then addiction has always been resistant to treatment.

[SNIP: Section on books and magazines (we predicted the Kindle reader!, boxes, labels, etc.)]

Now a paperless society, Lunar or L5, is an enormous challenge and we had better begin preparing for it. A whole spectrum of alternatives must be developed and ready-to-go to address the diversified applications of paper in our civilization that have so insinuated themselves into our way of life as to almost define it.

Greeting cards and love notes: One can foresee a non-commercial and unpoliceable use of homemade art papers (such as are now well represented in art fairs) and vegetable inks for this purpose. Maybe the contradiction of personal mass produced greeting cards will at last give way to something that really does show individual effort. A possible black market item.

I am sure I have not covered it all, but I hope the idea is clear. Lunar culture in full bloom will be quite different from ours. But one can be assured that given preparation NOW, these differences will not be impoverishing. On the contrary, they should be refreshing and enriching. Certainly there will be lessons learned that may help Earth bound culture find its way to a somewhat less disharmonious relationship with our own host world. **MMM**

The above article is online at: <http://www.asi.org/adb/06/09/03/02/004/paperchase2.html>



MMM # 5 May 1987

ESSAYS IN "M":

By Peter Kokh kokhmmm@aol.com

M IS FOR MIDDOORS:

On Earth we have been familiar with the distinction between indoors and outdoors for many thousands of years. In the last two decades or so, a new environment, the middoors, has become familiar to most of us in the form of the enclosed, climate-controlled streets and plazas of many a shopping mall. The "landscaped," sunlit central atrium in some new hotel or office buildings offers another kind of model.

In Lunar cities, except to enter and exit those (e.g. industrial) facilities which for safety's sake must keep their air unmixed with that of the city at large, it will be possible to go most anywhere without donning a space suit. Homes, schools, offices, farms, factories, and stores will exit, not to the airless, radiation-swept surface, but to a pressurized, soil-shielded, indirectly sunlit grid of walkways, residential streets, avenues, and parkways, parks, squares, and playgrounds.

While the temperature of traditionally indoor places could easily be maintained at "room comfort" levels, that of the inter-connecting middoors of the city could be allowed, through proper design, to register enough solar gain during the course of the long Lunar day (dayspan), and enough radiative loss during the long nocturnal period (night-span) to fluctuate 10 degrees F on either side, for example from 55-85 degrees F during the course of the month. "The Great Middoors" could be landscaped with plants thriving on this predictable variation. This would be both invigorating and healthy for people, plants, and animals alike, providing a psychologically beneficial monthly rhythm of tempered mini-seasons. Of course the middoors could also be designed to keep a steady temperature. But oh how boring that would be!

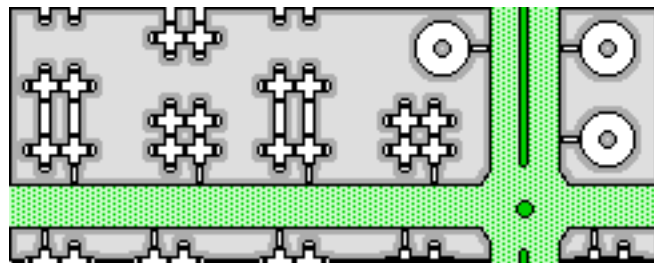

Section of a neighborhood: individual homes open onto pressurized "middoor" streets hosting the bulk of the settlement's modular biosphere. <MMM>

MMM # 7 July 1987

ESSAYS IN "M":

By Peter Kokh kokhmmm@aol.com

M FOR MONTH, OR SUNTH:

Originally, of course, the term "month" meant the span of a full set of four phases of the Moon, e.g. from full moon to full moon, or from new moon to new moon, terms which render the appearance of the Moon to the inhabitants of Earth. On the Moon itself, this lunar month of 29.53 Earth days would rather appear to denote a full set of phases of Earth, e.g. full earth to full earth, except that this definition of month would seem irrelevant to anyone living on the Farside from which Earth was never visible.

Rather, to the Lunar Settlers, this period, called a lunation by our astronomers, will simply signify the period from sunrise to sunrise or from sunset to sunset – wherever they happen to live on their adopted new home-world. From a Lunan's point of view, it's all about where the Sun is in their sky, and has nothing to do with Earth at all. Earth could cease to exist and their would be no more "full moons" or "new moons" to reckon by, Just the interval between sunrises or sunsets.

Introducing "the Sunth"

Accordingly, pioneers might well prefer to call it simply the "sunth." This term is less stuffy than "lunation" which is really a geocentric term signifying the period from "new moon to new moon." The term "sunth" and avoids confusion with our own Earth calendar months of Roman origin which do not coincide at all with lunar months as they average about a day longer in order to divide the year into twelve neat periods with no leftover days. The Sunth then would be the natural way of reckoning the passage of time on the Moon.

The Sunth will also be the primary consideration in scheduling activities that depend upon the availability of sunlight and/ or solar power. This will include mining and industrial operations, road building, and prospecting, The local time of Sunth will also determine the timing of agricultural chores.

MMM # 8 September 1987

Animal Life

in Settlement Biospheres

By Peter Kokh kokhmmm@aol.com

In her recent article in the first issue of Moon Miner's REVUE: "Some Preliminary Considerations for Lunar Agriculture", MLRS member Louise Rachel brought up the topic of animal life. Red worms in composting trays; honey bees and nectar sipping bats for pollination duty, honey, and guano; fish and chickens were mentioned as early contributors to the settlement's biosphere.

I have had lots of experience with bats (no doubt, some will say, in my belfry), but I had thought of them mostly as insect, blood, and fruit eaters. But apparently some tropical and semitropical plants depend on them for pollination. Another useful pollinator that might add delight as well would be various species of hummingbirds. And perhaps some species of butterflies!

For meat, rabbits and covies (guinea pigs -- they are a meat staple in their native Peru, breed fast, put on meat efficiently, and are easy to raise) would be good complements to chicken and fish, and both have extensive cuisines developed about them. For extra incentive, rabbit and cavy fur -- and even cavy wool -- would be welcome complements to cotton. Two Considerations for meat animals:

First, they should not require special food crops but should be able to thrive on the parts of plants grown for human consumption that are not eaten by man: cobs, leaves, stems, shoots, roots, etc. This way they are integrated into the human food chain and fit in the scheme of things by recycling vegetable and grain wastes. Increased, not decreased, food chain efficiency will result. Of course, the amount of such vegetable and grain waste will then set a limit on how much meat can be raised. But I would utterly disagree with James Lovelock (The Greening of Mars. Michael Allaby and James Lovelock, 1984, pages 126–9) that all animals are food rivals of man.

How much meat per person per day will this sensible stricture allow? Probably a lot less than most Americans are used to enjoying. Meat may either be reserved for special occasions or more likely used more as an ingredient or garnish instead of as an entree -- as in salads, casseroles, and stews, and as in oriental cuisines.

Second, food animals should convert fodder to protein efficiently. In general, smaller animals do a better job. Goats are more efficient milk producers than cows (and no, so far I haven't been game enough to try any) so that if the settlers wanted to move beyond soy substitutes for dairy products, then goats, not cows, will likely find a berth on the next ark. Urban Wildlife and Pets

But I am more concerned with human–animal interactions and thus with provision for pets and for planned urban "wildlife". In the lunar home, parrots, toucans, macaws, and similar colorful birds would be at home on perches in the solarium–garden and not need to be caged. Parakeets, budgies, and canaries, and other birds would also add song, color, and delight.

Other house animals should be small and sustainable on kitchen and table scraps -- vegetarian pets being far preferable for this reason. There might have to be some sort of restriction such as so many pounds or ounces of pet per so many pounds of family members. Vegetarian gerbils and hamsters and show breeds of Guinea pigs would be in line with these restrictions.

Unfortunately, dogs and cats are both relatively large, and what is worse, fare poorly on vegetarian diets. For inveterate dog lovers like myself (I have three) this would be one of the hardest sacrifices of accepting a chance to settle on the Moon. Meanwhile, monkeys, anyone?

If it were decided to introduce goats, thought should be given to restricting the herds to schools where students could take turns caring for them, even on off days. Nothing is better for the growing child than positive personal interaction with animals large enough to relate to. Student associations could sell Goat products to raise money for other activities. Even apart from the benefits of exposure to animal life, such Junior–Chamber–of–Commerce type activity will be invaluable as preparation for adult life.

If the lunar settlement's "streets" are indeed built to be greenways (see PARKWAYS in this issue), I would favor an urban wildlife of song and humming birds, butterflies, maybe even carefully chosen species of squirrels and chipmunks, all chosen with due consideration to ability to coexist with the plant life without becoming pests. A central parkway of generous width, complete with stream down the middle, might also support a small flock of ducks, swans, or even to truly suburbanize the place -- pink flamingos.

Animal haters notwithstanding, in all of human history there has never been a human community without its animals; and a world with no animal life would not be one I'd care to call "home". It is not only man who must go to the Moon and integrate it into the human scene, but GAIA, that is, Earth–life in general, in representative species, plant and animal alike.

Our historic path to becoming human has been inextricably bound up with animal life. We cannot stay human without continuing that involvement. <MMM>

COLONIST'S I.Q. QUIZ on Animals

Questions:

1. What species of animal life might over time develop larger forms in low lunar gravity?
2. Why someday might Luna City's floral gardens be famed throughout the Solar System?

3. What effects might lower gravity have on plants in general?
4. Will it rain inside lunar Colonies?
5. What handy feature does the Moon offer for experimenting with new species that might not be compatible with those already on the scene?

Answers:

1. Flying creatures have an upper limit on their growth on Earth that is imposed by weight / lift ratios. But large birds also need lots of room and the lack of this in lunar biomes may be the dominant factor.
2. Stalks could be taller, and blooms larger, without drooping. Floral forests may someday provide enchanting surroundings for romance, weddings, etc.
3. Being laden with fruit or moisture will be less stressful. Fluids will move upwards more easily, downwards less so, signaling physiological change.
4. Dew and dripping condensation, yes. Man-made mists and showers, yes. Rain, no. [Despite a great depiction of such an event in the subsequent 1991 ABC made for TV lunar helium-3 mining settlement classic, Plymouth.]
5. The high lunar vacuum imposes a natural quarantine between unconnected settlements or outlying facilities. Thus no two separate moonburgs need have the same flora (plants) or fauna (animals). Vive la difference!

The Quiz above and the article preceding are online at:

www.asi.org/6/9/3/2/008/animal-life.html

ESSAYS IN "M": Lessons in Biospherics

By Peter Kokh kokhmmm@aol.com

M is for Magenta, Maroon, Mauve and other natural plant colors. The lunar settlement's biosphere will be far too small and fragile to absorb the usually toxic and even carcinogenic byproducts of the production processes needed to make today's popular artificial dyes, many derived from coal tar as a feed stock. Rather, cotton – the fabric of choice for the Moon – will be dyed with indigo, henna, xanthene, even with chlorophyll and carotene – all dyes produced naturally by plants. If they are not as bright or as colorfast, that will be of little import in comparison to keeping the air, water, and soil sweet and fresh for tomorrow. Dye-source plants will then be an important part of lunar flora; and if the settlement farms do not have room to grow them, they may well find a place along landscaped settlement streets.

M s for Medicinals: Many pharmaceutical drugs are largely hydrogen and carbon, and low in elements already present abundantly on the Moon. So long as their metabolic byproducts are all eco-friendly and biodegradable, they can be freely imported from Earth and will add to the lunar biomass as a result of being consumed. But beyond that, medicinals will by and large be easily refined natural byproducts of carefully selected plants to be grown on the Moon. Other preparations will best be done without.

M is for Musk and other fragrances and cosmetics. As with dyes and medicinals, what cosmetics cannot be organically and naturally produced will have to be done without. They would be incompatible with the lunar biosphere both in synthesis and in decay. Plants with cosmetic value will thus be high on the list to green-up (pressurized) lunar byways. Some natural cosmetics are already on the shelves of health food stores on Earth, but work needs to be done.

M is for Mosquitoes, Moths, and Mice and other unwanted pests. One safeguard against accidental importation of pests along with foodstuffs and seed is to have all such cargo flushed, sealed, and packed with pure nitrogen. The hold of Moon-bound ships should be pressurized with pure nitrogen too, which the settlers needs anyway. Besides, the alternative is to import oxygen (in the air within cargo holds) which the Moon needs like Newcastle needs coal. Import efficiency is Priority # one.

M is for Mushrooms and edible fungi in general which feed on decaying plant matter, a usually neglected "soil" for food production. To achieve enhanced efficiency, a food chain designed for Moon settlements must rely on a strong fungal contribution as an essential element, not only in the form of the common mushroom (*agaricus campestris*) but making use of other edible species as well for an especially interesting cuisine. In this way, nutrition will be generated from both halves of the food cycle.

M is for Mold spores and airborne pollen In the closed and close settlement "atmospherule" (to coin an apt term) in which the total volume of air per person is vastly less than on Earth, it will be of critical importance to avoid importing, even accidentally, plants or their seed, of species which discharge pollen directly into the air, and of fungal species (sources of mold) which do the same. If such species need to be cultivated for any reason, they must be grown in quarters with a separate air supply and recycling system.

M is for Moisture. Plants will load the lunar settlement's air with moisture through transpiration, This humidity needs to be controlled. Dehumidifiers will produce drinking water as a bonus. Thus plants will be a prime factor in recycling water as well as refreshing the air.
<MMM>

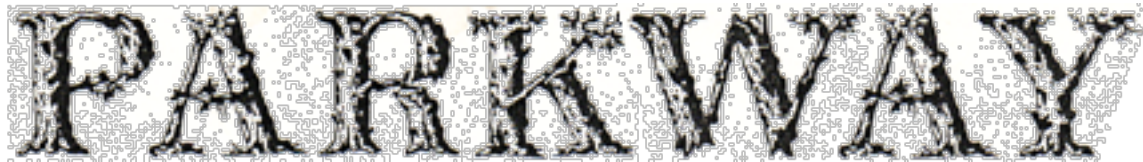

PARKWAY: Pressurized Greenways Within Lunar Towns

[The sixth in a series of articles on the need to pre-develop the "SOFTWARE" of a Lunar Civilization]

By Peter Kokh kokhmmm@aol.com

City Planning Considerations

Some months back, Myles Mullikin, the current Milwaukee Lunar Reclamation Society chapter president, and I got into an interesting discussion on how a lunar settlement, more than a mere Moonbase, might be laid out. Myles favored a strictly linear one street city, or at least a single arterial spine, on the grounds that experience with computer architecture showed that this was the most efficient type of layout.

However, even if it means, as Myles pointed out, more atmospheric volume and hence more tonnage of preciously imported nitrogen, I tend to favor some sort of grid system for two reasons. First it enhances physical networking, allowing people to interconnect over shorter distances; but especially since the extra total length of streets per given population would provide the opportunity to plant extra living biomass. The more of this biomass per person, the stronger will be the life-support flywheel for air and water purification, etc.

The Parkway's Role in the Biosphere and ideal plant species for Parkways

Parkway streets and avenues, pressurized and shielded but with solar access, could host such non-foodstuff plantings as pharmacopeia (medicinal) species; plants useful for preparation of natural cosmetics; plants whose extract can be used to dye cotton, like indigo and henna; plants to support a carefully chosen "urban wildlife"; and last but not least, flowering and blossoming plants to support honeybee colonies [perhaps an Australian stingless species].

Such a utilitarian selection (and here is where the software predevelopment homework comes in) will do double duty by refreshing the air outside agricultural areas of the settlement and at the same time providing a delightful and luxuriantly green "middoors" environment in which the settlers can go about their daily business in the reassuring context of "nature".

Ambience

There could be special fruits for the children to pick in assigned season. Sidewalk cafes could grow their own special salad and desert ingredients on location. Care for street-side plantings could be left in the hands of neighborhood residence and/or business associations who could landscape to their desire, providing the opportunity for each neighborhood to have its own unique ambience.

The Parkway Climate

MLRS member Louise Rachel in her article in last month's special premier Moon Miners' REVUE issue entitled "Some Preliminary Considerations for Lunar Agriculture", reminded us that many of the temperate zone plants we are familiar with will not grow and reproduce full cycle in a climate in which the temperature never falls to a cold enough level to reset them. This means the settlement's parkway streets will have to be planted with mostly subtropical species and varieties. In the continental U.S. there is only one major city whose climate lies exclusively in our proposed lunar middoor range (55 – 85 ° F) -- San Diego. If you have ever been to this jewel of a city and noticed how different is the local vegetation where you live, you get the idea.

The Parkway Ecosystem

We need to know not only what will grow under such conditions but what sort of ecological relationships must be maintained. What animal species are required for pollination, etc.? Should we let some varieties in the lunar community, which will tend to sow themselves and find their own balance, or pick only those over which we can keep tight control? Which plants will need how much care? Above all, which can we import not as seedlings or mature plants but as nitrogen-packed seeds to make sure there are no stowaways? What trees can be grown in dwarf varieties? There is so much we have to learn and the homework can begin now, even by educated laymen, maybe by you! <MMM>

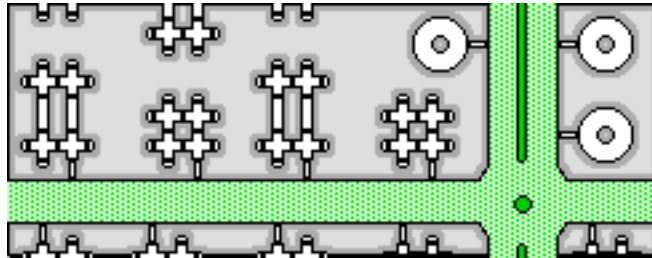

The "Middoors" is the key Biosphere Component In a modular settlement, allowed to grow as need be (not a fixed size mega-structure based on someone's guesstimate of future needs), modular habitats and other structures are connected to pressurized residential/commercial "streets." These "commons" contain the bulk of the settlement's biomass & biosphere.

MMM

MMM # 16 June 1988

Frontiers Have Rough Edges

A major theme running through many of the articles in the Manifesto has been this dual one:

- ✓ **Settlers can become largely self-sufficient** on a volatile-poor world like the Moon and in free-space oases initially dependent on lunar-sourced goods and raw materials.
- ✓ **This effort will involve widespread substitutions** (and "doing without" when substitutes can't be found) that will take some getting used to, as the pioneers wean themselves from an Earth-learned addiction to sophisticated organic materials so easily produced on the home-world only to be casually used, often just once, or even not at all, then just as casually thrown away.

The transplantation of human society from Solar Planet 3A, Earth, to Planet 3B, the Moon, will involve definite sacrifices for the early trailblazers.

There seem to many who, misguided by ill-thought out science-fiction scenarios, look forward to life on the space frontier in the expectation that there they will find the latest, the most advanced, the most sophisticated possible technological cultures. Such persons would best be jolted out os such

illusions and advised to stay home, on Earth. For to tell the truth, for some decades following the opening of out-settlement, it will be on Earth that the highest, most advanced, most sophisticated material civilization will exist, at least in the more fortunate areas. In contrast, off-Earth homestead scenes may seem insultingly drab, tedious, harsh.

Even so, 17th and 18th century Europeans who wanted the material best and most genteel that life had to offer, remained in Europe. Even so 19th century Eastern State Americans who wanted as comfortable and as materially gratifying a life as possible, remained in Boston, Philadelphia, Charleston. The frontier is for those for whom other things are far more important than creature comforts and sophistication.

Life in the new "outer Siberias" will be simpler, yes simpler, even if forever dependent on high technology. And it will also be a more authentic and honest life, with more attention given to things that count. There will be religiously rigorous recycling and careful accounting for everything.

The premium on craft, creativity, and ingenuity will be high; and the opportunity to indulge in consumerist shopping binges all but nonexistent. There will be glory for both teamwork and for individual contributions, but precious little room for unproductive self-involvement.

Despite the dependence on high technology, there will be a new partnership with nature in ark-sized biospheres, a heightened sensitivity to our symbiosis with plant and animal life, a realization that man and living nature thrive together or perish together.

Such prospects ought to appeal to many environment- and ecology-sensitive persons in the Mother Earth movement, types that many of us space advocates customarily dismiss as not worth courting, on the grounds that these crusaders often seem to want to throw out the technology-baby with its bathwater.

But this is a constituency that can enrich us and provide us with strength in alliance that we may never realize if we disdainfully choose to go it alone. If we love our cause, well set our egos aside and patiently woo these also concerned and energetic individuals. Lets go together, those of us with complementary right stuff! The rough edges of this frontier are a rasp for personal and cultural baggage best left behind. PK

MMM # 22 February 1989

[On the Moon, it will be important to "reuse or recycle" everything, and especially anything containing organic materials: **hydrogen, carbon, nitrogen**, which are in short supply on the Moon!]



On the Moon, Shorn Hair May be Zealously Saved for Various Uses

By André D. Joseph and Peter Kokh

In the early lunar settlements, many of the arts and crafts materials we take far granted will be scarce, if not altogether unavailable. Ceramics, glass, and sintered iron will be the probable mainstays for the Lunan artisan.

A scarcity of "soft" art & craft stuffs

Byproducts of the colony farms such as wood, pulp suitable for making craft papers, natural resins, etc. are not the easy answer. All such items contain about 50% exotic elements – lunar sources of the hydrogen, carbon and nitrogen components of organic matter may have to be supplemented with imports at great expense (the major savings in on-Luna agriculture will come from using lunar oxygen for the other 50%). There will be considerable economic incentive to recycle all 'waste' biomass.

Some such products, however, might well do temporary duty as craft materials for children, for example corn cobs and sheaths, as such 'works of art' are seldom long treasured and could be eventually recycled. But permanent withdrawal of such expensive organic matter from the biomass cycle will perhaps be all but taboo and governed by strict regulation.

Recycling in lunar and space settlements must be very thorough to be effective. The penalty for not pursuing this religiously would be a much lower standard of living for the settlers. A greater portion of the income earned from the settlement's exports would then have to be used to replace squandered volatiles, instead of for badly needed items to make life a little less harsh, or for imported volatiles intended for biosphere growth.

Making an exception for hair

A point of diminishing returns will be reached, however, and it would serve no purpose to carry recycling efforts to suffocating extremes. We would like to make the CASE FOR AN EXEMPTION at the outset. Let us decide beforehand, that any settler has the right to keep, without penalty, his or her own shorn hair 'for the purpose of self-adornment.'

Hair in the History of Arts & Crafts

Hair? Yes, the history of folk arts & crafts shows that shorn hair can be used in many ways that will make the edges of frontier life just a little bit less rough. To be sure, hair is not a widely used material in today's sophisticated craft scene! But this is not the only art and craft area in which early Lunans would do well to research the folk ways of times gone by.

Our first suggestion is quite obvious. Young girls could let their hair grow quite long. Their locks, when finally cut, could be made into falls, braids, and wigs that they could later don for dress-up occasions as blossoming teens or as mature women. (Young boys could do the same, if distinctively masculine styles of managing their long hair were used: turbans, anyone?) Even settler recruits might adopt as an honored custom the practice of letting their hair grow out, to be shorn later upon arrival in the settlement.

Hair as a macramé stuff?

Such shorn hair could also be done in macramé style with made-on-Luna beads and rings, and first worn in sort of a 'coming of age' event. This would all be but one small item in an increasingly distinctive Lunan culture. Hair based macramé could be used as well to fashion tasseled head bands and belts and interesting shoulderettes or shawls.

NSS Chapters Administrator Aleta Jackson ['89] points out that the Romans wove long maiden hair into luxurious ropes. These could be used for waist sash cords, purse handles, sandal uppers, etc.

Artistic use of short clippings!

We take for granted that in early adulthood and for most of one's life, frequent haircuts will probably be the rule. SAVE THOSE CLIPPINGS! They can be carefully sorted by color.

In the past, such clippings have been successfully ground up and used for craft pigments and stains (the characteristic palette of available colors will be small). "Hair-painted" home-fashioned ties, shirts and blouses, skirts, and hankies etc., could become a distinctive settlement craft much sought after by tourists from Earth.

In the past, medium length clippings have been painstakingly arranged in inlay and mosaic 'landscapes' and 'paintings.' Usually, the motivation behind such time-consuming work was to provide a treasured memento of a beloved departed one. But no matter; the point is that it can be done!

Hair as a composite stuff

Hair waste has also been combined with a resin to make rich looking beads and buttons. Even those combs, which are worn by women to keep their hair in place, could be made of their own shorn hair!

Recycling as the last resort

What about shorn hair unsuitable for any of the above self-adornment uses? This can either be placed in the appropriate compost bins or used as doll hair or stuffing, again to be ultimately recycled (unless of museum-bound quality!).

REFERENCES:

The Milwaukee Central Library's Art and craft reference collections contain only a few entries on the use of human hair but these seemed promising enough to warrant this article. We

are sure that a more thorough search of folk customs worldwide would bring to light additional interesting possibilities.

NOTE: Frontier Hair Cosmetics

While on this topic, we must keep in mind that the preparations available (and allowable!) to Lunans for hair care will be almost certainly limited to natural, minimally processed ones. However, this is all the people of earlier times had to serve their needs. Relax! It is unlikely that there will ever be any camels (or camel urine) on the Moon! **MMM**

MMM # 23 March 1989

TAILINGS

WASTE NOT, WANT NOT

By Peter Kokh kokhmmm@aol.com

TAILINGS: (TAY'lings) the residue of any process such as mining. The leavings.

The Challenge and the Opportunity

Anybody who has ever visited a mining area, has seen the large talus slopes or mounds of pea to acorn sized rubble of unwanted material that announce the approaches to mine openings. This is the chewed up and spit out host material in which the desired ore vein was embedded and which had to be removed to get at the prize. Tailings also refer to the the accumulated leavings after the sought after metal is extracted from its ore.

As a rule, the volume of tailings is enormously greater than that of the extracted ore. This is especially so with the noble metals, gold, silver, platinum, and copper. In the case of copper, for example, the volume of tailings to metal is typically 100:1.

To the environmentalist without imagination, tailings are a terrible eyesore. To the rare creative environmentalist and would-be entrepreneur, they are instead a vast untapped resource just begging to be put to work.

What is so special about tailings that would justify such a bold statement? Simply this: tailings have already under-gone a considerable amount of work. They have already been extracted from the mine site, and are already uniformly ground up into bite-sized pieces often of quite uni-form composition. As such they are already preprocessed and represent a substantial energy investment that goes utterly wasted when they are allowed to just sit there scarring the landscape.

In much of the world where rich ore veins exist, paradoxically there is often a scarcity of the traditional building materials. True friends of the Earth would quit wasting time ranting and raving about scenic eyesores and spend their time dili-gently experimenting with these tailings to see what sort of building materials they could be turned into, putting to advantage the energy investment that has already been made. Alas, creatively enterprising environmentalists are about as common as woolly mammoths.

Back on the Moon

On the Moon, we will find soils richer in this element, soils richer in that element, but likely only in degrees and percentages. While prospecting for especially rich deposits of strategic materials will have its ups and downs, probably more of the latter, basic needs will be able to be met by surface mining of the loose topsoil at almost any coastal site, as such areas have access to both the higher aluminum and calcium rich highland soils and the iron and titanium rich basaltic (lava flow) mare soils of the lunar 'seas'. Among coastal sites, those that

also have KREEP (potassium, rare earth elements, phosphorus) deposits will have a special advantage.

The ore company, let's call it Ore Galore Inc. or OGI, will first separate the loose lunar soil or fines into fractions by electrostatic and/or mechanical means. These fractions will then go to various processing facilities dedicated to the production of oxygen, iron, aluminum, titanium, magnesium, glass, glass fibers, and glass composites, lunar cement, etc. At the end of each processing line there will be leftover material, tailings. These tailings will often be as rich as the material that undergoes final processing, but will be discarded because they cannot be processed as easily or economically.

Now the principal lunar industries will be concerned with the two most urgent needs, export to pay the bills, and basic shelter: habitat construction. Frills, such as finishing materials, interior secondary building products, furnishings, etc., will have a much lower priority for OGI. The lunar entrepreneur, experimenting in free time if necessary, will have on hand any number of piles of tailings, each probably with some characteristic gross composition resulting from extraction of the different desired elements.

Tailings-based Building Materials: Reusing Spent Energy

The tailings at the Glax™ (glass-glass-composites) plant will differ from those of the Iron plant or of the cement plant etc. We could just leave them there, but considerable energy will then be wasted: the energy which has gone into their sorting and prior scavenging for adsorbed gasses. But the real opportunity that suggests itself is to turn these tailings into various secondary building products for finishing and furnishing habitat interiors at the settlers' labor-intensive leisure. These can include decorative panels (glax), tiles for walls and floors, ceramic and glass home wares, special glax compositions for distinctive furniture etc. OGI cannot be bothered with sourcing for such needs but will be only too happy to provide tailings for the taking. Simple opportunism, neighborly and environmentally aware to boot will work.

Consider the tile-maker. Tailings from the glax plant, when melted and cast, may yield tiles of one characteristic color pattern (very likely variegated), while those from the iron plant may yield another. Aha! variety! interest! choice! – the stuff to whet consumer appetites by allowing personalization and customizing of habitat interiors at leisure once the cookie-cutter pressurized habitat shells have been appropriately mass-produced in the least possible labor-intensive manner. In these various tailing piles lie the seed of incipient lunar entrepreneurialism and small business free enterprise.

The environment-respecting aspect of such products might be advantageously marketed as such to the aware consumer. For example, tiles made from cast tailings might be called 'slaks' (from 'slag').

There will be an especially great demand for coloring agents -- on the Moon that will mean metal oxides exclusively rather than the complex organic dyes made from coal tars etc., that we are used to -- coloring agents for ceramic glazes, stained glass, and special inorganic paints (probably using waterglass, liquid sodium silicate, as a base*) etc. Some tailing piles may be richer sources of one such colorant or the other. Some sources may be prized for yielding products of special textures or other properties.

When possible, reserving primary building materials for export products, tailings-based materials for domestic products.

On the one hand, because of the urgent priorities imposed by the need to justify the infant lunar settlement economically, basic end products such as iron, export quality glax, etc. could well be off limits to the home-improvement product manufacturer. On the other hand, using raw unprocessed regolith or soil may yield only a quickly boring and unvaried product line, and further disturb the surface. Pre-differentiated tailings offer a handy and elegant solution.

Test of Settlement Industrial Efficiency

There is perhaps no better single criterion by which to judge a society's environmental impact than **the degree to which its material culture uses resources in proportion to their**

availability. On Earth, our record is abysmal, even amongst cultures which 'live off the land.' We still discard as unwanted too much material after investing precious energy to sort through it for some prized content. If tailings-based building products industries were pursued vigorously here on the home world, there would be far fewer shelterless people in the world, if any, and their homes could be more substantial and satisfying. All it takes is a few people with justified environmental concerns who are willing, to spend more effort in concrete solutions than in raising hell. Complaining is so cheap!

On the Moon, industries should be built up to utilize all the elements present in abundance: with oxygen, iron, silicon, aluminum, titanium, and magnesium, the eventual uses are obvious though requiring different degrees of sophistication. Calcium is the one very abundant element, especially in the highlands, that is most likely to go underutilized.

Calcium, of course, is a major ingredient of cement, and Lunacrete, as investigators have begun to call it, is one of the most promising building materials for lunar installations, if and only if a cheap enough source of water, water-ice, or hydrogen can be located and accessed**. If not, the choices will be either to discard calcium with tailing piles being characteristically calcium-rich, or to accept the challenge of finding other ways to put it to use. "Whitewash" could be one of these. Dusting a settlement's habitat shielding mounds with calcium oxide would provide interesting contrast against the darker background, putting the settlement in the "limelight."

A lunar administration that grants licenses to enterprises might give tax or other incentives to those operations that are tailings based, to encourage opportunistic usage of material already extracted rather than allowing additional square kilometers of lunar soil to be mined. This can be done simply by refusing license to mine or use unprocessed lunar soil for the manufacture of "secondary" products.

Industries should be encouraged to organize in a **raw materials cascade** in which one industry uses for its raw materials the discards of another, until the ultimate residue is minimal or nonexistent. Not only would such a material civilization have **the highest standard of living at the lowest environmental impact**, it would also **use and reuse energy in the most efficient way**. Combine this with recycling, and **the ultimate test of a mature civilization is one without residue**. That is a stubborn goal, so hard to realize that it may seem economic fantasy to some, but one nonetheless worth insistently striving for. The rewards will be great. But above all, on a world where so little is handed to us on a silver platter, only such total use of what we do mine may allow us to beat the economic odds stacked against our success.

Next time you pass a tailing-scaped mining site on some Earthbound highway, stop and take another look. There are fortunes to be made in this unwanted stuff, and preparing for Moon-appropriate industrial protocols while filling vast unmet needs here below might not be such a bad idea. Now if I were still a young man! **MMM**

MMM # 26 JUNE 1989

TOY CHEST

TOY CHEST By Peter Kokh kokhmmm@aol.com

On the Moon or in a Space Colony, will children's toys be imported? Most likely there will be severe restrictions – a matter of priorities – on which kinds of items such settlements can support from Earth. During the early decades of scarce volatiles, the only luxury items that may be permitted in this up-the-well traffic are likely to be those made largely of strategic metals

(copper, platinum, gold, silver) hard to extract economically on the Moon; of easily reduced simple plastics like polypropylene; and finally of biodegradable matter low in-oxygen (e.g. beeswax can be melted down at 145°F to be recast in new shapes).

The noble metals are very unlikely to make the journey as toys, even temporarily, since their urgent need is in industrial applications. Plastics are the subject of the following article. Beeswax and other waxes are more likely to come as packing material rather than pre-molded miniature animals, astronauts, or phaser guns. It is quite clear there will be no TOYS-R-US in either a Luna City or some New Tucson colony at L5.

Rather the settlers will have available to than a limited inventory of toy stuffs and will learn to do quite well within such limits, as have all peoples before the current consumer paradise. Considering that toys in general are rupture-active with a half-life of about a week after purchase, there might be some relaxation on using soft wood from trees grown in the frontier community, provided it is not fouled with treatments of any sort (e.g. stain, paint, varnish) that would prevent its being eventually biodegraded. A good use of wood would be for modular toy construction kits: Lincoln Logs and Tinkertoys etc. (curious wonders of long ago). If silicon-saturated rubbers can be formulated, toys as well as tires will employ them.

Other biodegradables that can do 'detour duty' as temporary toys, in addition to the moldable and carvable beeswax already mentioned, are corncobs and husks - used by many cultures, seeds, kernels, and nuts for toy jewelry, beadwork, and mosaics; egg shells for decoration; and for modeling, organic play-doughs made from flour, water, salt, and sometimes baking soda. Helping the cook prepare such fancy but transitory table fare as decorated cakes and gingerbreads can serve a creative play function; and so can simply arranging given colored items about the home in pleasing still-life creations.

The cuddliest stuffed animal is a living non-stuffed one [see "Animal Life" in Tinker toys # 8 p.6]; and in a world ungraced by outdoor wildlife, pets will be especially important. But for artificial substitutes, space frontier folk should be no more hindered by the unavailability of soft foam, pliable synthetics, and other modern toy stuffs, than were the hardy pioneers inhabiting Earth in more rugged times. Old clothing (to be reborn as rag dolls and rag animals) and such items as raw cotton, seeds, corn silk, feathers, even shorn human hair can do toy duty.

Yarn seconds and looms should be available. Wood, wax, soap, even potatoes are used for temporary carvings. Recyclable home craft papers for wax crayons with unprocessed vegetable dyes or for water paints of the same simple composition present no problem. A library of books on old folk arts and crafts, toys, dolls, and games, should be of more than historical interest and inspiration to pioneers of this new frontier.

Toy vehicles (hopefully soil-moving equipment, prospector 'jeeps', over the road rigs, and sundry spacecraft rather than battle robo-tanks) can be made of cheap sintered or die-cast metals as they were prior to mid-20th-century before plastics became king. But all toys should be modular in construction, with parts that snap together in a variety of ways to develop the child's imagination, rather than specific fixed adult-designed offerings that disable the imagination. Board games will see cardboard and plastic replaced with glass, glass composites (GLAX*), ceramics, and sintered iron, enticing the craftsman to produce them with heirloom quality.

In general, however, given the small population and market, the selection of finished, ready-to-play-with toys available to the pioneer shopper will be small. Kits out of which a variety of such toys can be created in the exercise of one's imagination will be the rule. This will certainly be one of the healthier facets of the micro-market economies of the space frontier. But as the number of mutually trading frontier settlements grows, this wistfully idyllic situation could change.

Recycling will be 'the fourth R', a necessary ritual for the settlers, quintessential to survival and prosperity. In large measure, the collection and primary sorting of recyclables will be the duty/chore of older children. It would be natural to scavenge such binnage for items with toystuff potential. And so when it comes to making finished toys, this enterprise may be

left to the more artistic and craft-handy among these older youths with the younger children as the beneficiaries. This would help keep most adults free for the more pressing productive needs of the community.

MMM

THERMOPLASTICS

Subsidizable import for many uses

THERMOPLASTICS By Peter Kokh - kokhmmm@aol.com

Although it is rich in oxygen locked in its soil and rocks, the Moon is volatile poor, very poorly endowed with the other life-supporting elements: Hydrogen, Carbon, and Nitrogen. There is indeed a reservoir of these gasses adsorbed to the fine particles of the lunar soil through eons of incessant bombardment by the solar wind [see "Gas Scavenger" in MMM #23].

While we will certainly 'mine' such reserves to the extent that the methods for doing so are cheaper than wholesale upport from Earth, we will probably need more of these elements necessary for water and biomass than we can extract from routine soil-moving construction projects or as a byproduct of mining operations.

[The high cost of such vital elements will provide a strong motivation to develop the small Martian moons, Phobos & Deimos, thought to be rich sources of hydrocarbons. Despite their distance, the fuel needed to fetch volatiles from these two low-gravity worldlets is but a third that necessary for upport from nearby Earth.]

These same elements are basic to most plastics (nitrogen is used mainly for nylons; some plastics involve chlorine and fluorine). Until hydrogen and carbon become dirt-cheap on the Moon and Moon-supplied space colonies, it will be rather uneconomical to make anything of plastics that can either be made of something else, or simply done without. This will be the case for the early years on the space frontier.

Thermosetting Plastics

In general, plastics fall into two broad categories. Thermosetting plastics, commonly based an urea resins, set when heated and cannot be remolded. The only way to recycle items made of thermo-setting resins is to incinerate them. Incineration, in small totally closed environments such as a space colony or lunar settlement, could only be permitted if it was so thorough as to emit nothing except water, carbon dioxide, and benign recoverable ash. The standard of absolute purity required, would be difficult to realize in any economical way - though Earth's own need will drive experimenters to work towards this elusive goal. An expensive compromise would be to incinerate such items in a facility isolated from the rest of the settlement biosphere, recover scrubbed steam and carbon dioxide, and exhaust noxious emissions to the outside vacuum to be carried away harmlessly by the solar wind, but forever lost to reuse.

The only alternative to incineration is simply to discard items made of such materials, thus permanent banking (and wasting) their precious exotic (exo-lunar) content. This very high volatile replacement cost for thermosetting plastics will demand that they be absolutely reserved for those very few items that can in no way be made of any other material. Esthetics, ease of manufacture, through-color, light weight, easy-care and other luxury considerations are no match far the harsh reality of lunar biosphere economics.

Thermoplastics

Ninety percent of everyday plastics, however, belong to the second category: THERMOPLASTICS. These materials set through cooling, and can be either reheated and remolded, or shredded and refused. In other words, thermoplastics are recyclable if need be, and there will be the need on the early frontier.

Nonetheless, four observations are in order.

1st, even if recycled, thermoplastics tie up elements that could be used to increase the size of the biosphere to make it healthier, more self-maintaining -- the priority. Despite their ability to be recycled, thermoplastics should only be used on the frontier when wares of non-exotic composition (metal alloy, glass, glass composite, ceramic, etc.) would make totally unsatisfactory substitutes.

2nd, to have efficient recycling, it is indispensable to have error-free easy sorting of materials of different formulations. The surest way to do this would be color-doping according to a set assignment-protocol. This would mean forgoing all the neat tricks manufacturers use on Earth to disguise the character of materials and thus defeat recycling in advance. This stricture will be accepted, once the benefits of materials-honesty are seen. While in general, each kosher plastic with a mainly functional use would be available in only one hue, a formulation chosen for children's toys could be made in a full spectrum of colors IF it was further distinguishable, for example, by brightness, translucency, or iridescence. A color protocol can be applied with same versatility.

This and similar protocols of materials and surface treatment honesty designed to insure idiot-proof recycling ease, while designed to make lunar type civilization workable, will offer invaluable appropriate-technology spin-offs to Earth's throwaway society. Remember this when next you hear some dolt whine about space nuts wanting to pollute the universe.

3rd, having to give up a plethora of plastics and other synthetics has a strong positive fringe benefit: substitutes made of the inorganic materials on hand will not burn. Fire cannot be allowed in the closed environments of a space colony or a lunar settlement. There are no cubic miles of fresh air overhead for flushing out the smoke. Even the smallest fire must be avoided like the plague. When cheap sources of volatiles and efficient transportation finally make plastics and synthetics an economical choice, space pioneers will be wise to continue to do without them rather than play Russian Roulette with their safety. [Mars, blessed with the elements the Moon lacks, will be the tempting exception, and it may take a catastrophic but hopefully small fire to drive the point home.] By the same token, those thermoplastics which are allowed when substitution is impractical, must be formulated to be incombustible and/or to have NO toxic combustion byproducts. A low outgassing rate is also important.

4th, the production of plastics commonly involves byproducts (often toxic) for which no use is readily found. Thus it will be far cheaper, considering transportation costs alone, to have admissible plastics produced where the raw materials are (Earth, Phobos etc.) than to import raw feedstocks only a portion of which will end up in the ultimate product. Basing a synthetics industry on feedstocks of plant resins, waxes, and oils homegrown on the Moon saves nothing if the hydrogen and carbon involved has to be brought in from elsewhere in the first place. Only those lunar agricultural products which incorporate lunar-sourced oxygen and/or silicon provide savings over imports.

Thermoplastics as Stowaway Imports

The Cheapest Method of Entry by far for protocol-meeting protean thermoplastics will be not as ready-to-use-items but either as packing and packaging materials, or as replaceable items needed aboard the cargo vessel for the trip to the Moon but not for the return to Earth etc.

If the noncombustible standard can be met, polyester and polypropylene may see the widest variety of uses, especially for nondurable uses for which inorganic materials are less suited. Future Articles will look at specific areas in which such plastics may be part of the solution along with ingenious use of inorganic materials

BIODEGRADABLE PLASTICS TO THE RESCUE?

A recent article in *Science News* [May 6, 1989; Vol. 135 pp 282-3] reports on recent attempts to marry starches to polyesters and polystyrenes to provide serviceable plastics that can in effect be anaerobically composted. The starch content, varying upwards from 6-40% (the

goal of the experimenters being 60%), gives an avenue of attack for microorganisms. In the process, up to 15 percent of the 1200-carbon-long polyester molecules slowly decay into nontoxic 25-carbon waxes similar to those forming naturally on apples. Garbage bags made of the new material should be on the market within a year.

Terrestrial Spin-up Opportunities

Incentives to solve the "plastics problem" are strong. Plastics currently account for 7.2% of solid waste by weight and 32% by volume with only 0.5% being recycled. But the admitted driver for these experimenters is to find new markets for corn byproducts, i.e. starch. That's fine. It's how the system should work.

But a strong caveat is in order. This so-called 'decomposition' may break down films and other plastic items, but until hybrid plastics are made for which the decomposition is thorough, and until byproducts are produced that are actually taken back up into the biosphere cycle, available for food production etc., such processes which promise a bit of relief for some Earth-bound waste disposal headaches, will not necessarily make these new hybrid plastics good lunar citizens. On the Moon or space colony where hydrocarbons will likely be expensively acquired, they must be fully recyclable. So far, the progress achieved in producing "decomposable" plastics has only resulted in a more subtle form of out-of-sight-out-of-mind disposal method that involves indefinite 'banking' of much of the hydrocarbon content. But it's a start in the right direction! <MMM>

MMM # 31 December 1989

"GREEN EARTH, CLEAN MOON"

A PHILOSOPHY TO BREAK OUT OF CRADLES BY

By Peter Kokh kokhmmm@aol.com

It is hardly possible to turn on a TV or radio these days without hearing about some needless environmental disaster or another instance of criminal toxic waste dumping. As if the devil-take-the-hindmost side of American business were not enough, we are all becoming painfully aware of our own unintentional guilt in passing on to our children an Earth less green, atmosphere less fresh, water less pure, forests less vast, and wildlife less abundant than those we had inherited.

It is understandable that many of us are beginning to think of humanity as a cancer upon the good Earth. Greenpeace, an extremely active international environmental group, is lobbying to set aside all Antarctica as a World Natural Preserve, banning even scientific bases as an infringement. Give Greenpeace a time machine and its warriors would go back ten thousand years to prevent the first Siberian Indians-to-be from crossing the Bering Strait (or isthmus back then) so the Americas could remain unspoiled wilderness. Perhaps if they could go back further, they would have stood guard in the Sinai to limit mankind's ravages to Africa.

Both the trouble with this attitude, and the very real trouble that humankind poses for the environment, are grounded in the same 2000-year-old unquestioned acceptance of the premise that mankind and nature are opposed. Rather we are part of nature, a new part, a part that appears as Earth-life enters puberty. Indeed, Earth-life as a whole, or Gaia as it is now coming to be called, cannot reproduce itself, scatter its seed to worlds beyond its cocoon of space, without humanity. To reproduce, Gaia must undergo the anxious pubescent changes and adolescent tribulations that being-with-humanity brings with it. By the same token, it is not humanity that will go to "the Moon, Mars & beyond", it is Earth-life-including-humanity.

Quite frequently one hears the objection, why should we go back to the Moon? "Isn't polluting one world enough?" The legitimate disgust the speaker feels for what is going on here

on Earth is being transferred to the speaker's expectation of what must supposedly follow in space.

“Mankind will not change. As our reputed ancestors cannot be housebroken, it seems that we cannot be planet-broken. We are fated to go on fouling out nest forever.”

It is impossible to argue with pessimism, because, like optimism, it is grounded in temperament rather than reason. To those who wish to take the meliorist alternative – acceptance of the given as bad as it is with the determination to take it upwards from here – there is not only hope that we will change and are changing our act here on Earth – with painful and halting steps, yes – but it is also clear that the “opportunity” to foul our own nest will not follow us beyond our home planet!

Whether our stripes change or not, there are no forests on the Moon to cut, no air to poison, no groundwater or streams to pollute, no wildlife to drive to extinction. We are a danger to established biospheres, yes. But there is no biosphere on the Moon, nor Mars, nor anywhere else in the Solar System within our reach.

To live on the Moon, we must on the contrary bring mini-biospheres of Earth-life with us. But whereas on Earth we can do our mischief and not worry about the consequences till much later, the tiny islands of life we bring to the Moon and Mars will be far less forgiving. We sin against them, we pay the price pronto.

It becomes obvious that Lunar and Martian pioneers will have had to change their act under sentence of death. Not only will they have to live clean, work clean, and play clean, but they will, especially on the Moon, have to recycle totally (read 100%) all the things we are used to throwing away on Earth. It isn't that they will lack places to throw things. Rather, the hydrogen, carbon, and nitrogen that largely make up wood, paper, plastics, and synthetics are not easy to come by on the Moon and may have to be imported at very high expense. Everything thrown away must be subtracted from the standard of living. Indeed, pioneers will use precious little of such materials to begin with.

In learning to thrive on the Moon, hopefully before we go, we will learn many lessons and some valuable knowhow that will help us improve things here on Earth. While the motivation to clean up our act on Earth is weak but growing, on the space frontier, it will be do-or-die.

What about mining? Won't we scar the 'magnificent desolation' of the Lunar landscape? In truth, all the resources on the Moon are already lying loose in the regolith, the pre-pulverized and ready-to-scoop-up-and-process upper few yards of its surface. There is no need to either strip mine or deep mine or otherwise change the appearance of the surface. The eons-long processes that worked on Earth to concentrate ores in isolated veins and strata did not operate on the Moon. Yes, we can be sloppy, littering whatever does happen to be cheap. Only public care can prevent that.

To sum up,

We must reject the offered dilemma of a Virgin World versus a Raped World. MMM

MMM # 34 April 1990 – Celebrating Earth Day #20

The Many Space Benefits for Mother Earth

Editorial Essay by Peter Kokh

The sense of Earth as a fragile Oasis in Space has been greatly enforced by the view from space. The snapshot of the “Full Earth” taken by the Apollo 17 crew during their return from the Moon is quickly becoming the most popular photo of all time. Earth-love is in. Oasis-smarts are in.

The contributions of Space Technology to the cause of preserving what we can of the biological and environmental heritage of the Living Earth as we inherited it from previous generations of stewards, are already considerable – even fundamental to our present

attentiveness. Meteorology and communications satellites have played supporting roles to the various national Landsats. In their starring roles, these latter multi-spectral thematic-mappers have not only afforded us an ever-updated real-time census of Earth's forests, agricultural lands, deserts, and the snow cover. They have also revealed land use patterns, and sown blight, drought, silt content of waterways, red tides, and many other aspects relevant to understanding and realizing the true state of the environment and the rate at which it is changing, usually for the worse. To act appropriately, we need knowledge, and Earth monitoring satellites have provided us an "authority to consult."

"You ain't seen nothin' yet!" goes the saying. The nine giant Earth Observation Satellites (EOS) that will form the keystone of NASA's "Mission to Planet Earth" in the coming decade, are necessary both to give us accurate knowledge of all the key environmental "hot spots" and the means of timely assessment of the effectiveness of whatever well-intentioned remedial measures we have taken.

But the future role of Space Technology in the battle to preserve – and then restore – the Earth goes well beyond its distinguished service as a vantage point from which to detect, observe, and monitor. In a somewhat belated, but extremely welcome admission, NASA, in its report to the President on Moon-Mars options, notes that by one or more of three options, "the Moon has a role to play in the long-term supply of clean electricity to fill Earth's needs." Those three options are:

- Solar Power Satellites
- Fusion power plants fueled by Lunar Helium-3, and
- Relay transmission of power from a ring of solar arrays on the Moon itself.

Clean electric power generation will not solve all of our planet's environmental problems. As we learn how to design the valuable mini-biospheres needed to reencircle our settlements of unearthly horizons, we will learn lessons invaluable to our efforts to preserve and restore balances within Earth's surviving fragmented ecosystems. And as we learn to operate ultra-efficient and thorough recycling systems in these frontier communities, some of that technology will apply to situations below. This "Biosphere Benefit" will be major.

A "Healthy Earth" must also include a Healthy Cultural Environment with real opportunities to burst out of dream-squelching spiritual limits and horizons. It must express itself in a reinvigoration of education and of youthful dreams and opportunities. It can do this only through continuing interaction with an endless frontier. The renaissance of arts and crafts stimulated by frontier forms will be a part of this phenomenon.

Earth and the human soul will share a common fate. If, in misplaced concern, we act contraceptively to "keep Earth-life on Earth" in search of some lost pastoral Eden, we will have plunged ourselves into a Hell of no escape instead.

Earth Day 2070, the 100th Anniversary

What environmental achievements might we have realized Earthside eighty years from today as a benefit of space technology? Exploiting one or a combination of the three Space-Resource-Based options for eco-safe electrical power generation listed above, we could expect:

- a stabilization of the trend to global warming
- an end to acid rain
- some relief on the pressure to cut forest growth for fuel and for farmlands
- a spread of intensive greenhouse vegetable gardening
- a slowing of the pace in plant/animal extinctions
- a greatly reduced disparity in the general living standards between the developed and underdeveloped worlds.

No-holds-barred economics might give way to an alternate game based on Ecocustodial Economics. While nations may yet cling to their illusions of "sovereignty", various international institutions will channel a significant portion of their real interdependency. Modeling its acronym after an ancient Roman goddess of the Earth, **T.E.L.L.U.S.** or Terrestrial Ecocustodial

Liaison and Logistics Utilization Service, or something of the sort, may work to guarantee that previously slippery multinational conglomerates operate with responsibility.

U.N.E.S.C.O. rather than the old U.N. General Assembly may be the one body with representation from all Earth and off-planet nations alike. For while much of the U.N. agenda would be irrelevant and inapplicable off-planet, shared educational, social, and cultural concerns will always bind mankind's far-flung communities.

A.I.D.S. may no longer refer to the once dread and now long forgotten fatal STD, but rather to the **Asteroid Impact Deflection Service**, the current analog of military preparedness, only now aimed at inanimate objects capable of snuffing out life on Earth, rather than against fellow humans. And, whether we will have listened to "intelligent" radio signals from other star systems or not,

**We will have detected the oxygen-sweet "signatures"
of other "Earths" around some nearby star-suns**

"Earth Day" as celebrated beyond Mother Earth might naturally be transformed into a corresponding "**Children of Earth Day**" festival held throughout off-planet civilization. The matriotic toast – "To Gaia and the Gaiacules" – sums up the spirit of celebration of our Human-Gaian origins. Observed on a rhythm set by the adopted calendar-variant in use in each case, this holiday will become the occasion for rededication to the continued eco-custodialism and further bio-enrichment of all the offspring Oases of Earth-life that we have established throughout the Inner Solar System. PK

RECYCLING

RECYCLING By Peter Kokh

[This outline of materials-management systems appropriate for Space Frontier settlements ALSO addresses some persistent Earth-side problems.]

Recycling is an integral and essential aspect of our "tenancy" of whatever corner of the universe we occupy. It is custodial common sense. And if it is becoming sound economics here on Earth, it will be an absolutely vital cornerstone of economics on the Space Frontier.

ORGANIC & SYNTHETIC MATERIALS

First we'll need to recycle organic and synthetic materials derived from such volatile elements as hydrogen, nitrogen, and carbon which will not exist in the all-surrounding abundance we are accustomed to on Earth, even after we are able to supplement the vanishingly meager lunar sources with supplies from volatile-rich asteroids and comets. This self-discipline will be indispensable for Lunar Settlement, and highly advised for Space Colonies in near-Earth space.

Keeping the ratio of native lunar vs. exotic imported content as low as possible will alone allow any chance for a favorable trade balance and economic self-reliance. Thus priority must be given to our food and clothing needs in using these precious elements. The purpose of such an effort is to provide the lowest Cost of living, by stretching the service life of any volatiles imported at great expense and by reserving them for uses for which there are no substitutes.

INORGANIC MATERIALS

Contrary to intuitive expectations, it will also be salutary to recycle processed inorganic materials since they embody considerable energy expense already invested in extracting and processing them from raw regolith soils. The more energy-intensive a refined material is, the more to be gained from recycling it. Proper pricing of virgin materials will guarantee this outcome.

Tailings also embody the energy investment of their by-production, and using them to make secondary building products would capitalize on this investment. [See "TAILINGS" MMM # 25 above.

Even glass cullet and ceramic shards can be used e.g. embedded in glass matrix decorative panels covers, fronts, handles and knobs. In the case of inorganic materials the purpose of all this effort will first be to reduce total energy-generation requirements, a strongly economic motive. Second, it will help settlers to minimize the Acreage of surrounding moonscape that will need to be disturbed to maintain there a population of a given size, an aesthetic goal. This "discipline" will allow us to tread softly and caringly on the magnificent desolation of an adopted virgin world.

Our strategy for realizing this authentic way of life will have many subtargets. Appropriate product design, easy sortability, convenience, collection nodes, routing and route servicing, division of responsibility, supply versus demand volume-matching, entrepreneurial opportunities, youth and school involvement, contests, public discipline, tax incentives, and backup systems must all be given special attention.

RECYCLING - FOUR BASIC PATHWAYS

(1) **REUSING** of all refillable bottles and containers is the most obvious and most economic.

(2) **RECASTING** by crushing, shredding, melting, and then recasting fresh items is another. We do this with paper, aluminum, and plastics for example. This method is greatly hampered by unnecessary cross-contamination with durably-bonded unlike materials. As for markets for recycled temporary-use items, building products/furnishings best match supply.

(3) **RETAKING** or use-reassignment is a greatly underutilized third avenue. Timid examples are jelly jars designed for long reuse as drinking glasses and butter dishes designed to be reused as refrigerator ware. There have been at least three abortive efforts to design what has been termed a "world bottle", a glass beverage bottle ingeniously shaped to serve anew as a brick or building block. That is one task worth taking up afresh! Designing smaller high-fashion glass bottles for infrequently sold items, such as medicines, fragrances spices, etc., with a female-threaded punt on the bottom to match a male-threaded neck would allow combining these into stylish decorator spindles for any number of imaginative uses.

Formulating packaging and packing materials to serve as craft stuffs for artists or even as fertilizer for gardeners is a promising possibility. In any such dual purpose design effort, it will be critically important to find reassignment uses with adequate demand-potential to match, and use up, the full volume of supply. Otherwise any such efforts will be but futile and distracting gestures.

(4) **REPAIRING** is one avenue increasingly being abandoned because of high labor costs.

Repair costs, however, could be greatly reduced by more careful product design with greatly increased attention to assembly sequences and methods that are take-apart-friendly.

The present quest for seamless sophistication in appearance is one of several sirens luring manufactures in just opposite direction.

To repairing, we might add **refinishing and totally fresh makeover**. Even where repair or refurbishing is impractical, if the item in question cannot be economically disassembled, then the sundry parts that would need separately recycling will end up being irretrievably trashed.

Only the adoption of design and manufacturing methods not now in favor will make all this viable. Lunar manufacturers will need to sing this new tune. And frontier settlements cannot in the long run afford to import Earth-made items not knock-down friendly.

The extra cost of meeting these new requirements will be minor in comparison with Earth to Moon up-the-deep-gravity-well freight charges.

INSTITUTE FOR MOON-APPROPRIATE INDUSTRIAL DESIGN

No amount of recycling discipline on the part of our hardy pioneers will work without such a wholesale redesign of consumer goods. For this reason, we really do need to start now by establishing an Institute for Moon-appropriate Industrial Design. While aimed at meeting

demanding frontier requirements, the very constructiveness of this challenge should make such an Institute the prestige Alma Mater of choice for industrial design students the world over, regardless of whether they had any intentions of ever leaving their comparatively soft Earth lives behind.

INDUSTRIAL ENTERPRISES

The significant upfront role of industrial enterprises in creating a material culture in which much more extensive and thorough recycling is possible than in our current American experience, is not limited to proper product design. It should be the highest priority of Frontier Governments, to provide encouragement and incentives sufficient to ensure that the principal avenue of industrial diversification involve new enterprises wins the byproduct materials of those already in place. Again, this compounds the productivity of energy already spent.

Properly integrated industrial parks will involve suites of industries in an ecosystem of traded byproducts. In one highly successful entrepreneurial effort in Texas a few years ago, an enterprising computer buff went from plant to plant, asking for data and any unwanted supplies, scrap, and byproducts to put in his data bank. Within the first year, he was able to generate enough networking between sources of previously unadvertised supply and potential customers to take in a cool \$5 million for himself.

"With a good system, even those who do not care, will do the right thing. Without a good system, even those who do care, can't do the right thing."

Given goods that are separable, sortable, and economically recyclable, the consuming citizen will at last have an honest chance to do his/her part. But it is not enough to know what should be done. Both citizens and government must also realize that without proper organization, on several levels, it won't happen.

SORTING

"A place for everything and everything in its place" is not only an unbeatable philosophy for managing one's basement, attic, and closets. It also applies to the home and business recycling corners. Instantly identifiable bins or baskets must be conveniently arranged for every category to be sorted separately. There is no reason that home recycling centers have to look untidy, a hodgepodge of Rubber Maid baskets and paper bags. A top priority household product should be some sort of bin-susan or bin-rack setup. Why entrepreneurs aren't turning such things out here and now is beyond my comprehension.

On the Space Frontier we'll need a greater number of different bins than we do here, where the economy is only organized to take in paper, glass, aluminum and some plastics. [Milwaukee's Pollyanna Plastics is now negotiating with area recyclers to take all the vinyl bottles and (!) polystyrene foam packaging they can buy back from the public, in addition to PET and HDPE plastics.] Glass and glax*, ceramic shards, and the various metals; refillables and tradables, used cotton cloth, fiberglass fabrics, thermo-plastics, paper stuffs, dye stuffs, plus various compost categories all need separate bins.

A collection system with convenient nodes to see that all these items find their way back to the industries that can use them, is the next equally critical and indispensable element in the recycling triangle. Perhaps the electric delivery vans of the settlement could belong not to individual merchants but to materials circulation enterprises. They would pick up appropriate categories of disowned goods even as they deliver, a prerequisite for a license.

ALTERNATIVES AND OPTIONS

But there must be many alternative routings to make a system work. If containers and packages in which shoppers bring things home are designed to collapse or nest compactly, they could be reused conveniently. It might even be bad taste to leave home empty handed! Drop-off Centers could be conveniently central to each shopping area. Properly arranged and managed (a place for everything, remember?) They needn't be unsightly. Featuring lockers, public toilets, cafes, they could include floral gardens, stalls for artists and craftsmen, repair and makeover shops etc. And why not arts & crafts classes, street music, dress-up fashion and bauble shows, and even a "soap box" for those eager to share their concerns?

COTTAGE INDUSTRIES

"Scavenge and Trade" licenses could be given preferentially to those with cottage industries based on giving new life to cast-off materials and items. Art du Jour, serendipitous temporary sculptures made from collected items, could be a major draw. Such creations might feature those items and sort categories for which the supply exceeds demand in the hope of stimulating would-be entrepreneurs and artisans to discover fresh unsuspected possibilities in such over-available stuffs. Demonstration classes in artcrafts using recycled and discarded items would be in order.

In Space Frontier pioneer towns, "recycling" may finally 'come out of the Alley'

Farm-Mart Centers, wherever grocery shopping is done, should not only take in the appropriate refillable containers but also buy/sell sundry categories of compost and composting accessories such as paper stuffs (e.g. corn husks) and garden and kitchen scrap dye stuffs, bone, and fat could be handled separately from any compost that exceeds home garden needs.

Jailed inmates could do the heavy duty labor intensive disassembly work; pardons might be in order for those demonstrating their capacity to function as useful citizens by entrepreneurial development of markets for orphaned and high surplus sort categories clogging the network. Primary and Secondary School involvement will be crucial in making the system work. This is the subject of the next article. [see "The 4th R" just below]

ROLE OF THE UNIVERSITY

Finally, the frontier University has a role to play as orchestra leader. The University, not government bureaucracy, must assess how well the system is working, and develop needed improvements.

A University office would maintain the computerized current inventory of various depositories with a disciplined materials accounting system monitoring supply/demand imbalances, and circulation efficiency, assign identifying sortation logos and routings for new classes, and maintain updated guidelines on a utility cable channel (or website).

The University should supervise and assist entrepreneurial experimentation in its labs and shops to develop new materials and products that will take advantage of various kinds of discard stuffs that are in excess supply. As such it will be a principal incubator of new businesses and economic diversification.

The University's **Institute of Industrial Design** would work to find new ways to implement such philosophies as "whole sheet" scrapless design of product/accessory combos, "kosher" assembly of unlike materials for later ease of separate recycling, "honest surfacing" that utilizes the design advantage and character of materials undisguised by surface treatments that make proper sorting identification anything but easy.

VOLUME REDUCTION STRATEGIES

Not only must we provide for proper sorting and routing of those items to be recycled, we must take care that the system is not overwhelmed. Volume reduction strategies are in order.

In the USA, packaging materials constitute 40% of trash.

In MMM # 4 April '87 "PAPER CHASE" [above] we pointed out that wood, paper, and plastics will be prohibitively expensive. This whole fascinating topic of how to service the diverse packaging, labeling, and even the advertising needs of the settlement with minimum reliance on precious volatile-rich materials, that should be reserved to increase the mass of the biosphere "flywheel", will be the subject of a separate article in a later issue of MMM.

SUMMING UP:

We must not allow either Lunar or Space Settlements to be "born addicted" to a technology and culture of abundance and waste. All those elements needed to make this ambitious program work must be developed beforehand, pretested and predebugged before lunar settlement begins.

It would be best if as much of this as is appropriate could even be ready to go for the first NASA/International Moon Base. Those of us interested in off-planet settlement must begin the cooperative addiction-treatment program that will enable such a propitious fresh start, as well as create spinoffs that will aid in Earth's own environmental struggles.

Beating this addiction, from which we all suffer, will require a "wartime" dedication and inventiveness. Only to the degree we succeed will we prove ourselves worthy citizens of Earth's con-solar hinterland. < **MMM** >

Some Appropriate Quotations

"The Environment" – whether on Earth or on the Moon
it's a question of pay now, or pay much more, later.

"Yesterday is history, tomorrow is a mystery and today is a gift; that's why they call it 'the present.'"

– Eleanor Roosevelt

"NASA is not about the 'Adventure of Human Space Exploration,'
we are in the deadly serious business of saving the species."
Young

– John

Be concerned not with what others have failed to do.

That is beyond your power to change.

Be concerned rather with what you have failed or might fail to do.

Then the world will be all right.

THE FOURTH 'R'

THE FOURTH 'R' By Peter Kokh

Here on Earth, we imagine we can afford the luxury of continued general ignorance of the way our Biosphere works and what may be necessary to maintain its health. We allow our young people to drop out of school, and allow those who do complete their courses to graduate with empty heads. We assume Mother Earth will go on taking care of itself as it has from time immemorial. Those that want to worry – that's fine, let them do their thing. The rest of us – let's party!

In the miniature oases of life that Ecotects design, build, and seed with life on the Space Frontier, we will have no such luxury of aloofness or ignorance. Whether we prefer to live in space colonies, in lunar settlements, in pioneer Martian towns or elsewhere, the carefully set up envelopes of Earth-life, water, and atmosphere we'll need to coddle our existence beyond our native womb-world, will have minimum tolerances for healthy functioning. The ecological facts of-life in the fragile exclaves of Gaia-Humanity will be immediate in their critical importance.

A Space Frontier Biosphere or Oasis might be described as a closed mini-world where everyone "lives downwind and downstream from themselves".

This means relentless vigilance in keeping the water and air clean beyond any standards set on Earth. Food chains will be short or telescoped. And waste biomass and organic materials must be efficiently and quickly recycled.

To keep low both energy consumption and the need to radiate excess heat, we'll need to get the most product per energy-input/heat-output as possible. Recycling, which recycles the energy of original processing as well as goods themselves, will be essential for all classes of materials.

Back on Earth, environmental consciousness is rising and is now the highest we've ever known. Yet, polls show people only care enough to want "someone else" to take care of the problem, and to do so without causing any personal inconvenience or forcing unwelcome changes in lifestyle.

It should be clear that if any such attitudes were common within a Space Frontier Biosphere, an environmental catastrophe most likely without hope of recovery, would follow all too swiftly. Nor will it be enough to have "a high level" of individual responsibility. Everyone within such frontier communities has to be "oasis-wise". It must be Second Nature to the Pioneers to live as if the dawn of the next day depended upon their rigorous respect for the Biosphere-Facts-Of-Life. For indeed, we'll survive one day at a time.

The only way to guarantee an oasis-wise citizenry, is to teach "Eco-Sense" to the children, not as an elective, nor as a mere requisite for graduation that can be put off to the last minute, but as one backbone of their education. Recycling – of the air, water, and biomass; of organic, synthetic, and inorganic materials – must be as important as Reading, (w)Riting, and (a)Rithmetic. Children must be taught Recycling as the Fourth "R"! Eco-responsi-bility has to become second nature. For if it is something we have to "remember" to do, we'll only do it when it's convenient or when someone else is looking.

Space Frontier Schools will have then a major role to play in guaranteeing the survival of the settlements they serve. The pioneer youth must learn not merely how to sort discarded items properly, but have a good understanding of how used air, water, biomass, and the various sorts of consumer materials are each routed back into the system upon which their shared lives depend. They should understand the raw materials and byproducts interdependence of industries and the interrelatedness of all those kinds of life that make up their mini ecosystem.

Students could be assigned recycling chores appropriate to their grade level to give them hands-on appreciation of how things work. The goal is not merely to produce good consumers and insure oasis-wise home-economics, nor merely to produce good entrepreneurs, industrial managers and workers, but to ensure that each citizen has sufficient appreciation of the Biosphere-Facts-Of-Life on which community survival depends, to vote intelligently and support only responsible political efforts. For while "lunacy" can be tolerated on Earth, there's no place for it on the Moon itself, or elsewhere in space.

PRIMARY SCHOOL

In Primary School, rote learning of the types of things to be sorted and recycled separately, of their names, identifying clues, and routes by which they are cycled back into the system, and of the current market uses of recycled items can all be gradually introduced. In art classes the students would use only oasis-wise media and craft stuffs, coloring agents, and finishes.

In frontier homes children could gradually be entrusted with the responsibility to monitor and manage the recycling chores within their households. They should be introduced to kitchen and garden composting, learning which food or garden scraps need to be treated separately. They can be encouraged to make things of pride from materials and discarded items.

No small part of early education would be to equip youthful vocabulary with sets of keywords and phrases having strong positive connotations. "Trash" and "Wastes", words of ill-repute, could be replaced with "Freed" used as a noun i.e. stuff relieved of previous service and ready for reassignment. ("Tommy, please drop off the freed on your way to school.") The rehabilitation of "alley economics" must start with the young.

HIGH SCHOOL

At the High School level the entire curriculum should reflect Biosphere-Facts-Of-Life. In the teaching of Biology, attention should be given to natural air and water cycles and the steps at which these processes may need assistance within the mini-biosphere. The time it takes to biodegrade biomass waste and various types of organic materials should be covered. Not only

should the Chemistry of atmospheric gasses be taught but also the nature of toxins, how they are produced both-in nature and industry, and they can be neutralized or prevented.

In teaching Import/Export Economics, the very critical role of recycling volatiles and already embodied energy must be stressed. An honest "Materials Accounting System" ought to be taught with its corrective affect on Financial Depreciation and Expense Accounting. And as an ongoing class chore/project, the economics class could maintain a Computer Database on some subset of recyclables under supervision of the University.

In industrial arts the concept of Whole-Sheet Scrapless Design can-be-brought home with school contests and competitions. Entrepreneurialism in the service of recycling can be encouraged by the J.C.s and in Junior Achievement projects, stressing the use of recyclables for which the market is slow. Industry could provide school art classes with access to slag type sources of "accidental art" to be mounted or set for sale.

A very useful Extracurricular Activity, with supervision, would be to take in worn, broken, parts-missing, and cast-off small durable items, especially including toys. These could then be repaired and rehabilitated. And where this is impractical, the items could be disassembled so all materials needing to be recycled separately, can be. Time can be allotted for "Serendipity" ephemeral sculptures from such parts.

UNIVERSAL CIVIC SERVICE

Nor should this "immersion" in the spirit and process of oasis-wise recycling stop with graduation from high school. In space frontier communities, where there will always be more to do than people to do-it, a Universal Civic Service after high school might not be a bad idea. Manning and maintenance of streetside recycling nodes, with care for their attractiveness and efficiency, operating other nodes in the recycling system, and other "schlepping" chores such as accident cleanups and maintenance of Parks and alleys are one way a "Citizen-Candidate" might pay his/her dues to frontier society.

Biosphere Maintenance is another appropriate dues-paying activity: i.e. manning the water-treatment and air-freshening facilities, various yeoman farming duties such as sorting spoiled produce and other biomass "freed" into mushroom matrix, animal fodder, and general compost.

Apprenticeships in the trades using recycled materials might also be considered for citizen-candidates if there are not enough of the above-listed job slots available. Cleaning refillables and other labor-intensive duties in the various recycling chains may also be in order.

The grand result of this thorough three step education process (primary and secondary schools followed by a stint of universal civic service) would produce Space Frontier Citizens who fully appreciated the fragility of their particular oasis of life and who forever remained deeply predisposed to live and act in an oasis-wise manner. We might even put some of these education ideas to use right here on our home planet. < **MMM** >

"For a culture to be successful it has to teach its children to want to do what they have to do."

Margaret Mead

MMM # 36 June 1990

Biospherics Research Lags Behind Hardware R&D

Editorial Essay by Peter Kokh

If you read between the lines of most space scene commentaries, be they exhortations or complaints, one thing becomes clear; the writer seems to think that if only we would invest in the necessary hardware, budgeting more money for engineering research and development, we could bust the Space Frontier wide open. This is the case especially with those who would set deadlines or timetables for reaching a milestone e.g. "We ought to have a permanently occupied Moon Base by the year 2001!"

Something vital is being forgotten. In the process, these forgetful space advocates are working unwittingly to set us up for another painful false start, à la Apollo.

To establish communities beyond Earth that are more than mere caricatures, **we will need to provide mini-biospheres** in which settlers will live within closed-cycle environmental life support. We still lack any work-able ideas of how to build such a system.

Arizona's Biosphere II notwithstanding, our ideas on how to set up the mini-ecosystems that will fully support our existence without being crushed by our demands upon them, are at best, so much theory. In this light, even such modest and basic projects as the Milwaukee Lunar Reclamation Society's Guidelines for Experiments in Lunar Agriculture intended to zero in on minimum Lunar nightspan lighting requirements, and other projects such as determining the most practical and timely way to turn sterile moon dust into serviceable soil, are little more than cute amusements. There is so much practical biosphere knowhow that we lack! And we beg to fail if we don't address that lack.

By and large, a majority of space-interested persons come from the ranks of persons excited about engineering and computing developments, technological spin-offs, and the hard sciences. This makes for a lopsided, poorly rounded membership, inevitably reflected in Society policy and strategy.

It cannot be stressed enough that any space-faring civilization must also incorporate appropriate biosphere and agriculture expertise. We could reduce launch costs to a dollar a pound, and build a NASP fleet, even a space elevator and fast nuclear rockets by the hundreds – and the Space Frontier would remain teasingly beyond our grasp, if we have not also learned how we can re-encradle ourselves in the hostile reaches beyond Cradle Earth, in unearthy settings we propose to make ourselves equally at home.

NASA has now put CELSS (Closed Environmental Life Support System) research on hold for budget reasons. Where is the protest from space enthusiasts? We are more concerned with Shuttle-C, fair play for also-ran entrepreneurial launch companies, and other worthy but far less critical initiatives. Dared the would-be homesteaders of our past head west solely equipped with knowhow about covered wagons, telegraphy, mining, and horse-shoeing?

NSS sorely needs to broaden its recruitment pitch, and supporting literature, in an all-out effort to bring into full participation those whose backgrounds, or hobby interests, include biology, ecology, eco-systems, agriculture and gardening, even animal husbandry. The Society's excellent monthly magazine, Ad Astra, should reflect this balance correction by soliciting appropriate articles. NSS has said in the past that it foresees an open frontier in which there will be a place for people of all walks of life. That boast should be effective up-front policy, not just afterthought and window-dressing!

Many of us are impatient, blaming the government for delays in producing the hardware we'll need. We naively assume that once the hardware is ready, everything else will fall into place without our having to trouble our collective selves about it. It is both silly and self-defeating to set timetables and deadlines on such a basis. We ought to be more concerned with making sure that all we will need is in place before we return to the Moon to stay, than with when we will do so. **PK**

Everyday people, when challenged, are capable of the most extraordinary things.

"When ships to sail the void between the stars have been built,
there will step forth men to sail these ships."
(1571-1630)

Johannes Kepler

We shall not cease from exploration

And the end of all our exploring will be to arrive where we started

And know the place for the first time.

T. S. Eliot in "Four Quartets"

Quartets"

[BIOSPHERICS]

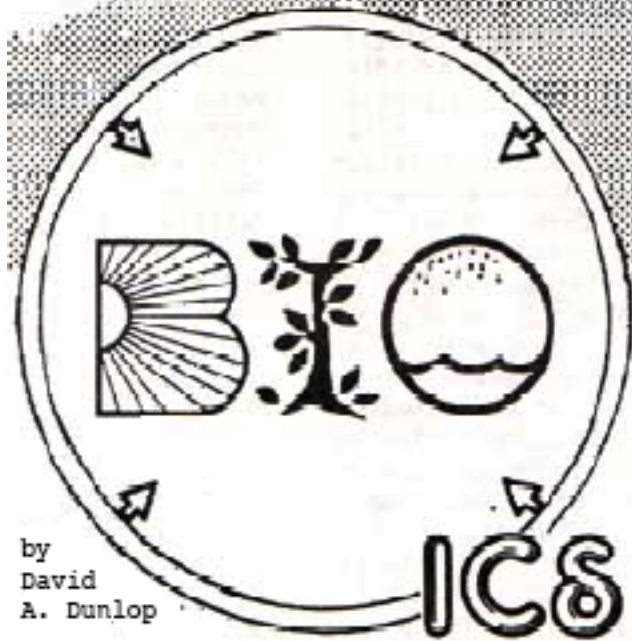

BIOSPHERICS By David A. Dunlop

DESIGN STRATEGY ISSUES FOR LARGE LUNAR BIOSPHERES

The development of a 3000 to 5000 person community will only be cost feasible within a 25 to 50 year timeframe, if it feeds itself and dependent Cislunar and Low Earth Orbit (LEO) populations. Doing this will leverage the economic advantage of abundant lunar oxygen which can provide half the mass of all plant and animal tissues and 8/9ths of the mass of the associated water. Foreseeable cost per pound, Earth surface to LEO and to cislunar and lunar surface locations, require such a "grow your own" strategy to save the unnecessary import cost of this oxygen content. Importing such high-oxygen content items as food and water to the Moon would be like bringing "Coals to Newcastle".

The substantial savings (circa 95%) in fuel costs of similar payloads launched from the Moon over those launched from the surface of the much more massive Earth, will give lunar-grown food, and water constituted with lunar oxygen, a 48% and 73% price advantage respectively, delivered to LEO and other cislunar space facilities. While this estimate discounts the high capital costs of accessing lunar resources, such costs can be amortized at a rate low enough to maintain most of this profit potential.

Prinzton* facility design criteria should favor the "low tech" approach of requiring the use of ample plant biomass to recycle carbon dioxide to fresh breathable oxygen and to otherwise "condition" the atmosphere inside the settlement. Indoor pollution, already a concern in contemporary terrestrial buildings using synthetic construction materials, will be a critical issue in a permanently enclosed biosphere which is essentially a closed system or at least one which has highly limited output leakage and input make-up in comparison to facilities of any size within Earth's biosphere.

* [PRINZTON was the name of a settlement in the National Space Society's 1988-9 1,000-5,000 person Space Habitat Design Competition. PRINZTON designed to be constructed in a Rille bottom, was the Lunar Reclamation Society's 2nd Prize winning entry.] This entry is serial-ized in MMM Classic #4. Download from http://www.moonsociety.org/publications/mmm_classics/

Vegetation will also likely provide the "low tech" water filtration and purification for the closed-cycle hydrosphere envisioned, with pure water recovered by dehumidifiers from plant transpiration supplying drinking water at the "start" of the loop.

The evolution of lunar habitat design will require a transition from the initial "carry out and bring back" strategy of Shuttle missions, Space Stations like Mir and Freedom, and early lunar surface habitats, to one which introduces a sustainable largely closed-system biotechnology. The ultimate significance of this transition recognizes that life itself will begin to transform the man-habitable environment just as life has transformed Earth. Indeed, the design myopia most likely to prevail in our "Prinzton" scenario is the continuing focus on human requirements in the narrow sense of air, water, and nutritional needs.

The scale of Prinzton's ambitions for a large human population demands a recognition that the "best" biosphere for humans is also the most diversified; "best" here defined as the most stable, self-sustaining and diverse community of life forms possible. The physical security of any large colony will require food stocks which are diversified and not subject to catastrophic mono-crop failures. While the Moon is close enough to quickly resupply food stocks or to evacuate in the event of a "potato famine" type of bio-catastrophy, a Mars base would be highly vulnerable given the 26-month launch window spacing and long transit times.

Early high priorities for base development will be the creation of lunar soils from the raw material of the rego-lith, human wastes, and wastes from food production and processing. The micro-ecology of creating a growing soil bank for sustainable agricultural production will require planned early storage of biological wastes for their ultimate transformation into viable soils. Frozen storage in the lunar "shade" of lava tubes or high latitude rille and crater walls should initially be adequate. This process of storage and accumulation cannot continue indefinitely, however. These wastes will necessarily become the organic stocks of the new biosphere.

The capital equipment investment needed for this transformation of waste stock can be kept in bounds by employing the "M.U.S./C.L.E." strategy of Massive, Unitary, and Simple type elements that can be locally self-manufactured, married to Complex, Lightweight, and Electronic type elements that must be imported from Earth. Such a strategy minimizes the import burden needed to sustain the growing settlement, an incurred debt which has to be paid for with income-earning exports.

First, a sealed-atmosphere, temperature-controlled, humidity-controlled, and light-controlled environment with considerable volume will be needed. Prior experimentation with the development of viable lunar soils from lunar regolith simulant and biowastes will have shown whether a lunar soil micro-ecology can develop from these waste sources and whether or what additional seed stocks of specialized soil bacteria will be needed.

A prototype trial of this sort might be conducted in a near-sterile Antarctic environment, such as one of the "Dry Valleys" near McMurdo Sound, to gain engineering experience in conditioning cold soil-sheltered volumes into airtight bio-spaces; and to validate the expected heating and lighting requirements, ingress/egress provisions, etc. 'Regolith' pulverized from Antarctic rock and the accumulated bio-wastes from nearby Antarctic bases would provide the basic ingredients for creating viable soils.

Because many of the international participants in Antarctic research are also spacefaring nations, the creation of a simulated lunar (or Martian) biosphere in such a location could provide an interesting collaboration precedent. It would also supply economic data on both construction costs and logistic requirements as well as on the design requirements for storing and recycling the biological wastes generated by such bases.

Because the "trashing" of the Antarctic environment is already apparent even with the relatively limited human intrusion there, this engineering prototype of a more ecosensitive system will serve not only lunar habitat goals but also provide a transition to an environmental ethic requiring such Arctic or Antarctic bases to live downwind and downstream of themselves, something that settlers in the closed biospheres of the space frontier must do.

The difference between such polar prototype research sites and such potential sites as lunar lava tubes or rille bottom enclosures is still considerable. Possibly some differences between Earth rock soils and lunar regolith, and certainly the available water and atmosphere, will make an Arctic or Antarctic experiment much simpler and far less costly.

However, construction techniques at these temperatures, experience with equipment design, and the logistic experience with working bases and their crews in the collection, storage and development of suitable soils for sustainable agriculture would be exercises alone. The failures experienced by such a prototype biosphere could literally save the billions of dollars that would be wasted if serious design flaws are uncovered only after lunar failures occur. An Antarctic proto-type installation will thus be sound risk management.

The selection of the type of biome(s) (eco-desert etc.) initially to be developed will also require closed system prototypes prior to any significant expansion of a lunar base. The strategy of Biosphere II at Oracle, Arizona in developing several diverse Biomes in close proximity, appears to this author to be a 'high stakes' gamble that homeostasis can be achieved and developed with a hybrid of existing natural biomes. A more conservative approach setting up just a temperate or tropical climate agricultural biome with an already known ecosystem of plants, animals, and insects, would seem to be a more simple initial step with a higher chance of stability.

The numeric modeling of each species' consumption, excretion, and impact on the other species sharing the biome, would enable the development of whatever fallback chemical and/or mechanical component may be needed to insure full-cycle balances within lunar biospheres. A species data bank, appropriate monitoring technology, computer software, and operations experience, all need to be accumulated to develop confidence and sophistication in running a sustainable biosphere.

This systems engineering problem is highly complicated and will require greater computing power to track the complex interactions between what will inevitably become hundreds, then thousands of species. The strategy of developing a replication of existing natural biomes and modeling them numerically should occur well before investment can be risked in a lunar application. Critical species serving as indicators of biospheric function (a miner's canary) must be identified.

Because Biosphere II in Arizona is essentially a proprietary enterprise, an independent critique of its outputs, systems engineering, and management techniques is unlikely to be generally available. This knowledge product may initially be affordable only to governments able to purchase this technology base. I am of the opinion that additional sealed biosphere prototypes both significantly smaller in scale than Biosphere II, and also considerably larger, will be needed to give confidence in the reliability of the biotechnology involved. This will need to follow a developmental progression from relatively simple and small biospheres to larger and more complex ones.

The outfitting of small Shuttle External Tank biosphere modules for initial lunar basing might progress to intact lava tubes. Such a tube could be sectioned off and sealed with needed environmental controls on the much larger scale of the Princeton arcology of villages, horticultural and agricultural areas, and production facilities.

Economics will not be the only primary rationale for biosphere development. Perhaps more importantly in the long run, the psychological comfort and stability of the human population will be critical. The stark beauty of the lunar landscape is unlikely to wear well on the human psyche. The "softened" environment created by plant and animal life will be an essential element of human expansion onto the Moon and elsewhere off the Earth. The "Garden of Eden" which we are rapidly destroying on Earth, will of necessity need to be reconstructed on the Moon. And tending this "garden" will be a major focus of human efforts there.

The type of high tech environment so familiar in space habitation scenarios usually have an overwhelming industrial character to them, emphasizing machinery, rockets, mining equipment, and power generation equipment, etc. Princeton's interior should more probably evoke a "hanging gardens" ambiance than that of a(n) aircraft "hangar". The very propensity of

life to intrude into all areas of its ecosphere will no doubt produce many unforeseen and unforeseeable problems of maintenance and equipment failure. Vacuum seals, for example, should be designed of materials that do not serve well as dinner for anaerobic bacteria or other denizens of microbial reality.

The tenacious battles for species dominance in biosphere eco-niches are dynamic balances that must be carefully observed and monitored. These tasks of bio-maintenance and monitoring will initially be labor-intensive. The ratio of settlement population devoted to biotechnology including growing food, harvesting, packing, storing, preparation, and general bio-maintenance and monitoring will likely comprise 25% to 50% of personnel responsibilities. Thus the character of the settlement will be as much dominated by agriculture as by the other industries such as mining, oxygen-, metal-, glass-, and ceramic production, transportation, and research and development efforts, etc.

The cost-per-pound economics of importing anything up out of the Earth's gravity well dictate an inevitable reliance on lunar-grown food stuffs just as they do for lunar-sourced fuel and building products. The curve of off-planet population growth will for the next century be more limited by lunar agricultural capacity than by other technology constraints. Neither Earth-based or Mars-based agriculture are likely to have economic significance outside their own respective gravity wells. Large scale sustainable biosphere construction in the asteroid belt will be possible only toward the end of this hundred year time frame given the probable stress on Martian and lunar development during that interval. < MMM >MMM # 38 September 1990

PRIMAGE

"PRIMAGE" – A "Do or Die" Key to Lunar Industrial-Agricultural Success
CONCEPTS OF REGOLITH PRIMAGE By Peter Kokh

The pre-tilling of the Moon

Through eons of meteorite bombardment, lunar soils have been extensively "gardened" or turned over vertically, and even mixed horizontally – up to half the surface materials in any given area is the import of splashout (impact ejecta) from areas nearby and distant alike. On Earth, mineral-based industries have been able to take advantage of enriched and concentrated deposits – a result of eons of geological processes peculiar to our planet. While undoubtedly somewhat more favorable concentrations of a few minerals do occur on the Moon (homogenization provided by bombardment not being 100% thorough), in general lunar settlers will have no choice but to make do with deposits we would shun as "uneconomic".

While the Moon is richly endowed, in a gross sense, the lunar economy will have the much more difficult job of separating out or beneficiating the desirable minerals prior to processing. No one should imagine that just any system of lunar mining-based economy would guarantee success.

In "Gas Scavenger" [MMM # 23 p.4 March 1989 – republished in MMM Classics #3] we pointed out that if we religiously extracted the pure iron fines and all the Solar Wind deposited gases from any and all regolith that we had to move or handle anyway, we would then accumulate potentially valuable reserves, at low cost, that could be one principal means of diversifying the settlement economy. We have to move regolith in excavating for shelters, in covering them with shielding, in grading roadways, and in providing raw materials to ore processing facilities. Iron fine removal (by magnet) and gas extraction (by heat) capabilities should be an integral part of ALL regolith-moving equipment, we counseled.

Agricultural Needs

Let's carry the argument further. Apparently, some of the things that worry lunar agriculture researchers most, are actually characteristics of 'gross' lunar regolith easily changed

in the handling process. After all, settlers won't be erecting domes over undisturbed lunar regolith, then attempt to farm this raw soil. We will be building pressurized agricultural modules of whatever volume – and then, moving regolith from the outside into the prepared beds within.

Researchers worry that the 15–20% fraction of regolith which is ultra-fine powder of less than 0.25 mm grain size, fine to medium silt, will clog soil pores leading to water-logged soil. In the Moon's light 'sixthweight', water will percolate through the soil more slowly; thus we will want somewhat coarser soil than is ideal on Earth. In the course of bringing regolith-soil in from the outside, this fine silt can be removed by vibration-sieving or by 'winnowing'. As a bonus, this unwanted fine silt may have a higher content of adsorbed Solar Wind gases; also it may be easier to process in some ways (glass?, ceramics? etc.,) than less refined 'as-is' regolith.

The 75% ideal medium-sand-through-coarse-silt 1.0–0.25 mm fraction is next. A 3rd sieve removes larger agglutinate glass nodules which can then be transformed into zeolites by mild hydrothermal process-ing [150°C , 0.3 MPa, 76 h].

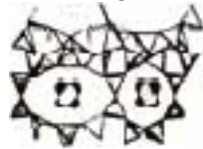

Zeolites are hydrated silicates of aluminum with alkali metals (K, Na) and cavity-rich crystal lattice

Crystal lattice structures:

They can be used as catalysts, adsorption media for gas separation, insulation, and molecular sieves. And added back into the “soil”, they will enhance mineral ion transport to plant roots, especially in early 'immature' soils not yet fully colonized by microorganisms nor laden with organic matter. How to provide for sufficient mineral ion transport in regolith-derived soils is thus another needless worry on the part of researchers. * [In view of these possibilities, I am rather critical of the value of lunar agriculture experiments that use any lunar simulants formulated on the unexamined presupposition that we will be stuck with using crude raw regolith.]

The remnant after this last sieving operation would be larger rocks (aggregates and breccias) that could serve well as gravel fill, for lunar concrete. So, just by including this multistep vibra-sieving operation in our "Regolith-mover", we will have (1) enormously enhanced the chances of success for lunar agriculture; (2–5) started businesses in molecular sieves, gas-separation, catalysts, and insulation; (6) supply the highly refined material needed for processing; and (7) supply coarser material for 'lunarcrete' mix.

A third worry of the Lun-Ag people is potentially toxic levels of chromium and of nickel in regolith-derived soil. Their concern is perhaps more justified with chromium, as observed nickel concentrations are possibly tolerable. How we could make use of regolith pre-handling opportunities To extract a significant fraction of the Chromium-containing minerals (e.g. some spinels) is a nice challenge for the chemical-engineering types among our readers. How about it?

A Tool for Many Needs

Now that's quite a work load for our everyday Lunar 'Lith-Mover! Iron fines; Solar Wind gases; silt for processing; Aggrade soil; zeolite feed stocks (glasses) for agriculture filtration and insulation; gravel for lunarcrete; chromium ores. We can obtain all these in the very handling of regolith, prior to all other forms of processing – including oxygen-extraction and glass-glass composites (Glax) production. For these collective First Fruits, I propose the term “Primage.” [Most dictionaries define this term solely as a safe handling bribe paid by a shipper to ship's captain and crew. But as a suggestive precedent, the O.E.D. also has: “the amount of water carried off suspended in the steam from a boiler” (about 3%)]

A Primaging 'Lith-Mover

Going through all the bother of careful regolith-primage, much like scraping and sanding the loose paint before repainting, will seem to most a thankless and unwelcome ritual. There

will be a strong temptation to dismiss the need. But the settlement that adopts primaging as a transcendental imperative, will have a significant head start towards economic diversification and self-sufficiency.

Primaging could be the wellspring both of prosperous lunar industry and of productive lunar agriculture. Developing a practical, simple and rugged "Primaging 'Lith-Mover" should then be among our very highest priorities. < MMM >



Logo by Fred Fleischmann and Peter Kokh
Report by Peter Kokh

The Birth of LUNAX

There is a new kid on the block in the effort to pre-develop the repertory of technologies that will someday enable us to establish the sizable self-supporting settlements on the Moon that will at last make mankind a multi-world species. Some people, it is true, still labor under the assumption that such a grand goal is merely a matter of money, hardware, and national will. Leaving them to their comforting illusions, some of us in the Milwaukee Lunar Reclamation Society have quietly started to peck away at the still growing load of homework that will really be necessary, in the hopes of finding ways to contribute which will test the limits of our collective talents.

In the process of working on our entry in NSS' Space Habitat Design Competition (1989) Lunar Base Category, alerted by a "whoa!" from collaborator Joe Suszynski of Chicago, the new Milwaukee Space Tech & Rec team [MilStar] identified one serious potential show-stopper. Unlike a smaller outpost probably powered by a nuclear reactor, a larger settlement may be economically strapped to use that energy available to it in as efficient a way as possible – at least until prosperity from trade reached a point where the settlers could burn up the ergs in a more customary carefree American style! To get the community's vital food crops through the fourteen day long lunar nightspan with the same amount of light provided 'free' by the Sun during dayspan, would take a power generation capacity several times as large at that needed to take care of all the settlement's other needs such as construction, industry, transportation, air/water circulation and treatment, etc.

A Need to Experiment

Realizing that any settlement's success might in large part depend on knowing how little and/or how infrequently their plants needed a light-fix during the nightspan to coast until the next dayspan growth period – and still produce an acceptable harvest – our SSI support group, Milwaukee Space Studies Team (MiSST) put together a small pamphlet aimed at enlisting home hobby gardeners. "Guidelines for Experiments in Lunar Agriculture" is slowly getting more exposure and sparking lots of interest.

However, interest is painless (i.e. cheap). Taking the trouble to carefully perform these lighting experiments in one's basement or garage on a plant species of one's choice seems to be another matter. Simply put, the data from our rag tag green thumb army of enthused participants is not flooding in. We will need lots of data on lots of different plants. Even though it will not be possible to rigorously control experiment conditions, a lot of data might yet

provide a good enough signal to noise ratio to enable us to pick out significant results from spurious ones. But how do we get that flood of data?

[Early Soviet experiments showed that if the plants are simply chilled to a few degrees above freezing, they would survive two weeks of darkness just fine, springing back during the alternating two weeks of light-feast to produce good yield. Eric Drexler, while still in high school, performed a similar closet vs. refrigerator type experiment with corroborating results. But even though temperatures would fall off once the Sun had set, at a rate that depended on the effectiveness of the insulation and the amount of the thermal mass within the farming unit, it might still take a considerable energy expenditure to induce the proper chill level, all at once, then maintain it – even if heat pumps were used to dump the heat into a eutectic salt or water reservoir from which it could be recovered near the end of nightspan, when heat was most needed. Chilling the cropow-hoknowhows may be one part of the answer – but we still need to know all our options!]

Getting Organized

To the rescue, MLRS member-at-large David A. Dunlop of Green Bay, Wisconsin; I first met Dave at the '89 Neptune/Triton Voyager Encounter party at the Fox Valley Planetarium in Menasha a year ago. Dave became quite enthused about our Prinztown Lunar Base design study. That fall, he started making the long drive down to Milwaukee twice a month to take part in our brainstorming sessions on a possible book to expand upon our Prinztown study. These sessions would often last into the wee a.m. hours, after having adjourned from the Central Library's Old Board Room to the nearby I-Hop, or some all other 24 hour eatery.

When we took up the proposed chapter on Agriculture and the Biosphere, Dave became riveted on the challenge of the quite limited extent and rudimentary level of appropriate experience and knowhow available. Not only do we need to know all our lighting options, we need to know how to transform sterile Soil that has never known air or water into a medium that can sustain its crop yield season after season, not just once. We needed to determine what plants, and what microorganisms, would work together in a very limited ecosystem. We needed to know a lot of things. And in point of fact, all we really know now is that we need to know one heck of a lot more!

Late one evening, Dave's call interrupted Star Trek TNG with a challenge. We need lots of data and it simply isn't coming in from individuals. Why not organize the "Lunar Nightspan Hardiness" Experiment and perhaps some other suitable agricultural experiments and then enlist High School Science Teachers, with the hope of getting more data, and data of better quality? Not being one to come up with an idea and then go hide, Dave immediately started networking, beginning with fellow Green Bay NSS member Neil Walker, high school science teacher. Through Neil, Dave got in touch with Ed Mueller in Neenah, Secretary of the Wisconsin Society of High School Science Teachers. Further calls uncovered considerable interest, even enthusiasm, for the idea.

Next Dave started calling select professional researchers in the field, with NASA connections, to solicit their ideas and comments. This was 'rough work', especially considering that NASA's efforts have concentrated on the food supply and biosphere needs of very limited small outposts – unrealistic models for what we proposed to do. Most of the Pros seemed to take it for granted that we'd have all the lighting energy we wanted on the Moon, and that crops would be raised in isolated and automated phone booth size pressure chambers. Once Dave backed up and explained to them our much more ambitious perspective, they showed a heightened interest, curiosity, and willingness to give advice and assistance.

Now that we began to feel confident that we had found a promising approach, the task became one of organizing. On June 23rd Dave and I drove up to Sturgeon Bay in Wisconsin's beautiful Door County, to meet his friend, attorney and Chicago restaurateur, Albert H. Beaver Jr. There in his office we drew up papers for a new nonprofit corporation, with the three of us as Directors, to pursue the effort to involve schools in those areas of Lunar Agricultural Research wherein the present rudimentary level of our knowledge still leaves room for meaningful school-level contributions. **A Magic Setting**

Al owns a private resort, the **Chateau Hutter**, along the Bay shore, nine miles north of Sturgeon Bay, and we decided to use this "ideal" facility to host an "**Invitational Workshop**" for a short list of high school science teachers and professional researchers (some by teleconferencing) to carefully define an initial set of experiments, and establish an Advisory Board and Reporting System to keep the process going.

The 1st LUNAX™ Workshop–Conference was set for Tuesday thru Thursday, August 21st–23rd. Because it was necessary to limit attendance to a dozen or so in order to insure results, and because this brash initiative was not guaranteed success, we decided not to publicize the event outside the chapter. **LUNAX I is now history.**

Thanks to a truly magic mix of individuals of varied talent, endless enthusiasm and deep conviction, we succeeded in defining our goals and designing an initial 2–track set of experiments. The Lunar Nightspan Hardiness Experiment (here we are looking for the limits of crop failure) will begin with a practice run using Wisconsin Fast Plants' Brassica rapa, able to go from seed to maturity in 28 days, and used in thousands of schools across the country. We will then seek to zero in on the nightspan hardiness of a wide variety of food and fiber plants that may make attractive candidates for the Lunar Biosphere.

We also prepared guidelines for an open–ended multiyear Lunar Soil Evolution Experiment using MINNESOTA LUNAR SIMULANT (here we are looking to find strategies for success). Three additional experiment tracks are in process of development, each of them aimed at supplying knowledge we do not now have, but which we will need if a "Return To The Moon to Stay" is to be successful.

Prospects

We are off to a propitious start and it's time to let the cat out of the bag. We will be field–testing our initial LUNAX experiment package in about a dozen schools in Wisconsin. The next step is a major presentation at the annual convention of Wisconsin Science Teachers in Manitowoc, next April 19–20th, before spreading participation throughout the country and abroad.

Our purpose will not be just to teach already known space science. Rather, by reaching out through the hitherto untapped resource of H.S. Biology and Agscience Teachers, we offer kids a "unique opportunity" to contribute brand new science of vital importance.

Agreeing to serve on LUNAX' Board of Science Advisors: Mel R. Oleson of Boeing Aerospace, Seattle; Gary G. Lake, Clarke & Associates, Technical Director Wisconsin Fast Plants, UW–Madison (from Brisbane, Queensland); C. William Easterwood, the U. of Florida in Gainesville (and formerly at the LAND, Epcot Center); and Paul W. Weiblen (of Minnesota Lunar Simulants) U. of Minnesota Space Science Center, Minneapolis. LUNAX will most likely be based in Green Bay, Wisconsin.

Wisconsin high schools anxious to premier the LUNAX Experiment Package include Chippewa Falls (McDowell), Green Bay (East, Preble) Madison (Memorial, West), Milwaukee (Bayview, Rufus King), Neenah (Shattuck), Racine (Park), and Waukesha. We can expect to pick up more schools as word of this unique science opportunity spreads.

LUNAX' immediate task will be to gain experience with the initial experiment package worked out at Chateau Hutter, and to guide the follow up research, while continuing to define complementary experiment directions. A modest school registration fee system will allow results to be gathered and analyzed, new experiment projects to be developed, and a newsletter (Harvest Moon) to be published. Individual hobby–gardeners and armchair fans outside the school system will be able to participate in or follow LUNAX progress. MiSST's pioneer work will be continued by LUNAX.

We also hope to tap talent at the community college level. We have a fine start here at Lac Court Oreilles Community College in Hayward.

The challenge facing Lunar National Agricultural Experiment Corporation is an exciting one. While the work to be done is frighteningly enormous, the team gathered at Chateau Hutter begins with the confidence of being on the right track. MMM will keep readers informed with

updates on our progress. We welcome this first addition to Lunar Reclamation Society Inc.'s new family of roll-up-the-sleeves partnerships. < MMM >

Polders, A Space Colony Model

POLDERS: A Space Colony Model By Marcia W. Buxton*

* Cultural Anthropologist & founder of Northwest L5 Society Chapter (now Seattle L5/1) in June 1996

From the beginning of human civilization families have made sacrifices for their children and for future generations. In order for human civilization to continue it seems self evident that families must eventually move into space and become a spacefaring people. An interesting parallel can be drawn between the familial movement into space colonies and the Renaissance development of the Polder System in the low countries of Europe. Each is truly an artificially created environment.

"A polder is a piece of land won from the sea of inland water and is constantly defended from it thereafter," explains Paul Wagret in Polderlands. Beginning in the 11th Century along the Northern Coast of Europe families labored to painstakingly force the sea to relinquish land in order to provide farm land for their progeny. These brave men and women worked hard to provide future land not for themselves but for their children and their children's children. In the same way serious thought must be given by all families today to look to space colonies to provide a better life for their future generations.

The family structure as it had developed by the 11th Century, in what is now the Netherlands, decreed that at a husband's death his widow received half his wealth excluding his land. All his farm land went to his eldest son and the remaining wealth was divided among the brothers. This custom allowed for a large enough area of farm land to be passed from one generation to another to sustain at least the eldest son. Daughters were generally expected to marry or enter convents to pray, teach, copy manuscripts and care for the sick. The remaining sons frequently were prepared to enter guilds to become expert weavers or other sorts of craftsmen. The center of cloth production was the city of Antwerp. Other sons might choose the monastic life.

In France, wealthy Lords would often grant monks the right to the marsh land on the edges of their properties provided that the monks endeavored to successfully drain the land for pastures and maintain them as polders. This "reclaimed" land was theirs henceforth. Here they constructed their religious buildings including stone towers which could be used as shelters in times of floods by the people living in the low lands.

Mont St. Michel is an example.

In the areas of Friesland, Zealand, and Flanders much of the land was a brackish peat bog bounded on the North by the Sea (illustration below). As the population expanded, the digging of peat to be dried and used as fuel became necessary. The word "polder" may derive from the Flemish word poelen, meaning "to dig out". This digging was done in conjunction with the digging of ditches for the drainage of the brackish water into the sea. This lowered the water table and the people learned that when these [newly] created dry areas were planted in clover and desalinated with natural rainwater, eventually this area became land where cattle could graze and much later hops, hemp, flax, colseed, rapeseed, cereals, and finally flowers could be grown successfully. This often became the land of second and later sons.

In order to aid the drainage of the low lands, canals needed to be constructed. Dikes using woven willow twigs and burnt clay bricks were built systematically to keep the brackish water from returning to the hard earned low crop lands. The area is often six feet below sea level. Great care needed to be taken not to dig for peat too near the dikes which might be weakened causing catastrophe.

By the 13th Century primitive windmills and lifting dredger buckets were established along these "highways" of brackish water. Younger sons became inheritors of the early windmills. Bridges, locks, and paths were built along the canals to aid the families in fetching drinking water which often could only be obtained by going a considerable distance to an area where rainwater collected sufficiently for fresh water wells.

At the end of the 15th Century due to religious persecution in other countries many immigrants, particularly Anabaptists and Mennonites who refused to bear arms, fled to the low countries. Here the ruling class, perhaps because some of their ancestors had been among the Crusaders in the Holy Lands and had opened up early trade routes and welcomed new ideas and foreigners, respected these people who were willing to work so very hard to drain fields and maintain the polders. And they, as other polder workers, were exempted from military service and payment of land taxes. These immigrants were allowed to organize their own schools and churches.

The development of the canal and polder system was not without many real catastrophes. There was often great destruction but always followed by rebuilding. The canals also began to serve other purposes and small barges were used to develop an efficient system of primitive commerce, dispersing beer, wine and salt. With the beginning of commerce came certain restrictions. Members of the ruling class, usually people owning large amounts of land but who lived in the towns and villages, began to demand tribute for the use of the canals near the villages.

The continuing need to dig for peat for fuel which enhanced the reclamation of the low lands, the emergence of the windmills, the building of locks, and the slowly developing system of commerce encouraged the establishment of "high water authorities" and water boards. Voting rights depended upon ownership of farm land. Among the peoples of Utrecht, Netherland, Zeeland, and Flanders there were to become in the 14th Century the *hoogheemraadschappen* or high water authorities and [they were] responsible only to the governments. At the local level these *Waterschappen* came to serve the function as a court of law.

Just as the marsh lands were reclaimed from the sea with embankments, with increases in population attention needed to be paid to reinforcing the coastal sand dunes along the North Sea. Wagret describes a polder dike as being perhaps 40 meters in width, but a main sea dike may reach 80 to 100 meters in width. The ebb and flow of the tidal currents along the sea coast sometimes caused erosion.

Jan de Vries, in *The Dutch Rural Economy in the Golden Age*, remarks that rural districts were prohibited from brewing, spinning, weaving, or ship building but that skippers of barges passing villages were required to dock, unload their cargo and allow their goods to be offered. In 1575 there were elaborate plans made which are reminiscent of the early plans and dreams in the 1970's of the L5 Society for Gerard O'Neill's High Frontier. His "Bernal Spheres" concept, housing 10,000 people, were to be nearly a mile in circumference and rotate to provide gravity comparable to that of Earth. The L5 Society proposed building such habitats by the end of the twentieth century from lunar materials to provide living space for workers and their families in a space manufacturing complex producing, among other things, satellite solar power stations to supply cheap, clean power to Earth.

Immigrants to Bernal Spheres were to develop a better life for themselves and for future generations. It may not have been by digging peat out of low lying bogs and creating drainage ditches, but by using materials from the Moon, colonies would be created and solar energy would be utilized to grow food in a closed system, and eventually there would be trees, streams, attractive housing, and a peaceful environment for future generations. One space colony would act as a stepping stone to the building of others.

The *Haarlemmer Meer* Book of 1575, by Jan Adriaanszoon, describes an elaborate plan to build 160 windmills and to build extensive canals to drain a major lake area. Like the L5 Society's early dream it was not developed immediately but finally with the invention of the steam engine the project became a reality in 1852.

By 1607 the Leeghwater's Beemster drainage project using 43 windmills created 17,500 acres of usable acreage. Some of the money necessary to finance this project came from the highly successful Amsterdam merchants of the East India Company, trading primarily spices, sugar, coffee and tea. Land owners were encouraged to grow livestock to provide large amounts of butter, cheese, and livestock that could be exported abroad.

Near Amsterdam by 1649, six villages combined efforts to provide a dairy for the nearby city, using their farm lands for that purpose.

Capitalists beginning in 1612 developed ambitious large scale peat digging organizations. Plots were carefully laid out as were canals and locks where settlers dug the peat and later were able to claim the soil as homesteads [illustration below].

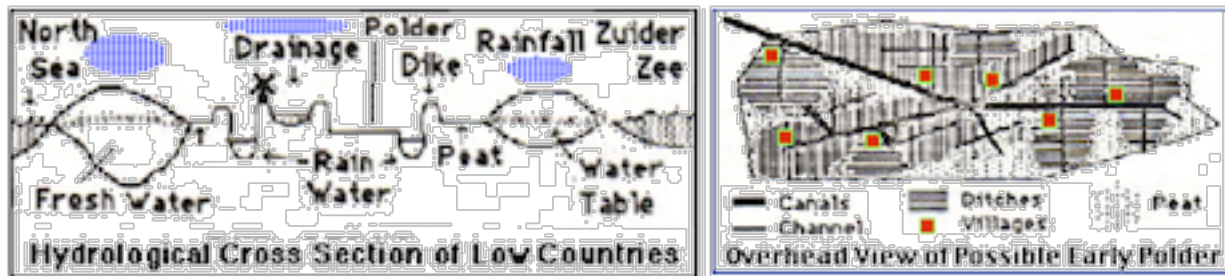

According to de Vries, "dike maintenance was an obligation divided among the villages that benefited from it." A land user was responsible for a specific segment and the Waterschappen supervised the system.

Windmill operators took on growing importance and were expected to keep the polders dry throughout the winter. In 1574 an 8 sided windmill was worth 3,500 guilder and the salary of a mill operator was 100 guilder plus a supply of candles in order to work at night! Rapeseed became a frequent polder crop and oil-pressing windmills in Northern areas often were kept busy the entire year. Windmills were also used for sawing wood [harvested] from carefully tended groves of trees.

de Vries writes that "the monastic lands yearly yielded several hundred thousand guilder for the support of education, health and welfare. Women played a very important role in the life of the religious community. Churches played a major part in the communities providing some education, but literacy in the majority remained low. Nevertheless five universities were established.

Canals became of increasing importance and interconnected the major villages and cities. Barging guilds were formed and established regular service between major cities. Frank E. Haggett sites that by the mid 1650's 80,000 acres had been reclaimed from the sea. The farmers taxed themselves hundreds of thousands of guilder yearly to improve the quality of their soil. Sea shells were ground up and used for fertilizer. Everywhere farm structures and homes were enlarged or rebuilt. Commerce along the canals flourished.

In 1667 there was a proposal to polder an inland sea, the Zuider Zee (See Figure 3). Hendrik Stevin developed the idea of closing off the incoming tide with sluice gates but allowing the ebbing tides to flow into the sea. Eventually the fresh water would replace the salt water sea. (The project was actually begun in 1927 and the first crops harvested in 1933 with 175,000 acres eventually reclaimed.)

By 1798 there were over 3,000 local Waterschappen and a central Waterstaat was created to fight against major floods. "The state set itself up as a protector against floods, the hereditary enemy of the country. The Waterstaat undertook works too large for small groups, collected data, coordinated hydrological observations and drew up maps. According to Wagret, 577,905 acres, or fourteen percent of what is now the Netherlands, had been reclaimed from the sea. The cost of the reclamation always exceeded the actual value of the land first brought into cultivation – only future generations were to be the true beneficiaries.

A worthy cliché, "God made the Earth, except Holland, which the Dutchmen made for themselves."

Might that we, with God's help, break free of Earth and build the Universe for ourselves!

MMM

References:

- **Barnouw, Adrian J.** The Pageant of Netherlands History. New York: Longmans, 1952.
- **De Vries, Jan.** The Dutch Rural Economy in the Golden Age 1500 – 1700. New Haven: Yale University Press, 1974.
- **Hugger, Frank E.** The Modern Netherlands, New York: Praeger, 1971.
- **O'Neill, Gerard K.** The High Frontier: Human Colonies in Space, New York: Doubleday, 1976.
- **Rachlis, Eugene.** The Low Countries New York: Time Life Books Spier, Peter. Of Dikes and Windmills. New York: Doubleday, 1969.
- **Vanveen, John.** Dredge. Drain. Reclaim. The Art of a Nation. 1962
- **Wagret, Paul,** Polderlands. London: Methuen & Co. 1959.
- **Note:** It is in the above sense that the word "Reclamation" is used in "Lunar Reclamation Society."

MMM # 39 October 1990

Saving Money on Food in Space: Prior and Future Progress

By Peter Kokh kokhmmm@aol.com

\$400/oz or the price of gold these days, works out to \$6400/lb. The way we have been making anti-progress in slashing the cost per pound of getting anything to orbit, much less from there all the way to a soft landing on the Moon, that would be a very optimistic ballpark guesstimate of just the 'freight-added' cost of anything upported from the Earth to early lunar outposts.

Everyone recognizes the importance of finding ways for early settlers to self-manufacture the more massive items they will need, out of whatever materials they can process from moon dust. But often I hear "Oh, we could afford to import this or that – it hardly weighs anything!" Hey, just remember, it will cost more than gold!

Thus it is not surprising that it seems self-evident to most people that it will be an urgent priority for lunar outpost volunteers, and the settlers that someday will follow, to grow their own food – 'it would cost too much to haul it up from Earth.' But this common wisdom is a bit simplistic, nonetheless. Let's take a look at some very real virtual savings in food costs already realized even though we still do bring all food up from Earth – in one form or another.



we use water manufactured in space as a by-product of the orbiter chemical fuel cell energy system which runs on hydrogen and oxygen. Yes, we bring these bottled gases up from Earth – but now, we are not 'also' bringing up extra water just for food and drink.

bottled fuel freeze ready
H₂ + O₂ +++++> H₂O + dried = to eat
gases cell items FOOD

Now that's real savings!

When the first returnees establish our beachhead outpost on some 'magnifi-cently

desolate' lunar plain, even before their prototype food-growing unit brings in its maiden harvest of vegetables, they can realize another 89% breakthrough in food and drink costs as soon as they start using oxygen 'squeezed' from the Moon rocks to make up that associated water of hydration.

At this stage, we will be upporting only hydrogen and freeze dried foods. So, when our nifty little 'agricule' starts spitting out real fresh food we save the total cost of upporting freeze dried food, right? Not quite! All we save by this loving garden-tending labor of raising our own up-home food supply is another 53% of what we can get our regolith-soil to supply.

Typical composition of oven-dry biomass from wheat, for example, is:

- 48.0% Oxygen
- 2.0% Calcium
- 0.8% Magnesium
- 0.01% Iron

all of which we can get from our make-do soil, plus some 2.7% Potassium, 0.8% Sulfur, and 0.6% Phosphorous of which we can get perhaps half from the regolith.

The rest must be upported from Earth: 36% Carbon, 6% Hydrogen, 3% Nitrogen, and perhaps half of the Sulfur, Potassium, and Phosphorous.

Settlers will strive to mitigate this burden by vigorously recycling their waste biomass and anything else of organic content, by withdrawing from the productive biosphere as little organic material as possible (i.e. no wood for furniture or other items, where substitution is possible), and by carefully engineering all entry/exit systems to conserve nitrogen-rich air supplies.

[See "**Liquid Airlocks**" in MMM # 17 July '88 p3 – republished in **MMM Classics #2**]

How could we make inroads into this stubborn balance? This still onerous import burden will drive settlement policy.

As much as 2/3 rds of the upport transportation fuel cost can be saved by bringing in the needed Carbon, Nitrogen, and Hydrogen as liquid methane and ammonia processed on Phobos and/or Deimos, the companion mini moons of Mars. The capital costs of installing such a production capacity could easily be amortized as the lunar population grows. The profits realized at Mars could defray the costs of opening up the Martian frontier. A doubly attractive strategy!

There is one way, however, that lunar settlements might become totally self-sufficient in food. And that is by supplying all their Carbon, Nitrogen, and Hydrogen needs as byproducts of extensive Helium-3 mining operations to supply Earth's voracious energy appetite. Of these, in comparison to lunar demand, the least abundant by far is Nitrogen – which will be the limiting factor on settlement growth, mostly because of the high volumes needed as a buffer gas in air. Hopefully, profits from Helium-3 exports will allow the settlers to pay the import price of as much extra Nitrogen as they'd like.

What we have said about food is equally valid for usually forgotten but vitally important byproducts of prospective lunar agriculture: fiber (cotton, linen, flax), oils, natural biodegradable dye stuffs, cosmetics and soaps, and other eco-friendly household products. Of these, fiber for clothing, toweling, bedding, and furnishings will likely receive the earliest priority.

Saving money on the Moon by defraying avoidable upports from Earth is only one part of the Story. Lunar agriculture even in the early era when all Carbon, Nitrogen, and Hydrogen must be imported, has the potential to earn badly needed export income for the settlement. For Luna-grown food, simply for the Oxygen savings it realizes, will be deliverable to low Earth orbit and other space locations at a decided price advantage over fresh food brought up from Earth. Ditto for fabrics and anything else incorporating lunar Oxygen. Early production of oxygen is then the key to everything else, and all the fuss about lunar agriculture presupposes this development.

The space frontier economy will be a complex hierarchy of supplies and demands. We hope you can appreciate the great potential for diversification ahead – if we do our

MOON MINING & COMMON ECO-SENSE

By Peter Kokh kokhmmm@aol.com

The multi-thousand-year-long record of human mining activities on our home planet will surely be enough to convince even the most bribe-prone galactic bureaucrat to deny us required permits to extend such resource extraction efforts off-planet. In default of such red tape, it is left up to us to judge and police ourselves.

With mines come huge ugly piles of useless barren tailings and scarred landscapes slow to heal, streams poisoned with acid run-off, and legions of workers with dust-racked lungs. The record gives pause to those considering opening up pristine eco-vulnerable Antarctica for development of its legendary mineral wealth. Should it not also give pause to those who look with such high expectations to the plains and rolling highlands of our serene gray neighbor, the Moon?

The salient points to remember are these:

(1) The Moon's mineral endowment has been minimally differentiated or locally concentrated and is thus distributed rather homogeneously, by Earth comparisons, in ores that are extremely poor by our standards. There will be no reason to fight over deposits or jump another's claim.

(2) There is no reason to believe that richer deposits lie buried deep beneath the already pulverized regolith blanket that covers the entire surface to a depth of some 2-5 meters. In effect, countless ancient meteorites by their bombardment have already "pre-mined" the surface for us. There is no need for open pit mining.

(3) As to what does lie deeper, the central peaks of the larger craters represent up-thrusted material from several kilometers below - sample and source enough should we need it. There will be no need to deep tunnel the Moon.

(4) In the absence of atmosphere, any and all dust 'kicked-up' by our various activities, has nothing to suspend it above the surface, and is quickly purged from the near-surface vacuum by the Moon's light but effective 1/6th gravity.

(5) Tailings, the unwanted residue after resource extraction, will be visibly indistinguishable from the source material. Tailing mounds will blend in with the moon-scape, and if preferable, can be raked back over the surface. The only clue to an area's having been mined will be a telltale absence of minor craterlets. Tailings should usually be minimal, nonetheless, since more than one resource will be extracted leaving little more than the proverbial squeal of the pig.

[See "Tailings" in MMM # 23 March '89 reprinted above]

(6) Fluids and gases used in the extraction process such as water, hydrogen, hydrofluoric acid, chlorine etc. must be brought from Earth at great expense. So resource extraction cannot possibly be accomplished economically unless ways are found to recover and recycle these reagents almost totally (read 99%). There will be no mass leachate drainage into the environment.

(7) Even in the case of accidental spills of reagent leachings, there is no lunar ground water to pollute or spread the problem. Spills will remain localized and it will be an economic imperative to recover as much as possible.

(8) Miners, if you can call them that, will not be breathing atmosphere in contact with the regolith they are processing. Health concerns will instead focus on minimizing accidents and exposure to cosmic rays and rare solar flares.

(9) As to housekeeping activities of miners themselves in their shielded habitat warrens, they too must recycle and conserve religiously [see "Saving Money on food in Space" - pp. 34-35, above]. They will assuredly be acutely aware that living immediately "downwind" and "downstream" of themselves in cradling mini-biospheres leaves scant room for eco-

carelessness. As long as private enterprise – carrying the baggage of the almighty "bottom line" – is the agent in question, we can rest assured that sheer economic necessity will work mightily to prevent 'eco-nonsense' on the Moon. The real danger would come with government leadership and its deferrable accountability. When you hear or read someone express alarm at prospects for developing the Moon, remember these points. A good response with this as with any challenge: "That's just what I used to think – until I looked into the matter further!" < MMM >

Is the Moon a wasteland?

"There is no such thing as waste, there are only resources we are too stupid to know how to use."

Arthur C. Clarke – to Walter Cronkite during launch of Apollo 13

MMM #40 – NOVEMBER 1990

CLOACAL vs. TRITREME PLUMBING

CLOACAL VS. TRITREME PLUMBING

By Peter Kokh

The Best Plumbing System for Lunar and Space Settlement Biospheres?

cloaca: (clo AH ka) = a common cavity into which the intestinal, urinary, and reproductive canals open in birds, reptiles, amphibians, and monotremes (the lowest order of mammals).

monotreme: (mo NO treem) = either of the two remaining species (duck bill platypus and spiny anteater) of the lowest, most primitive order of mammals, with one hole for all discharges.

SCENE: the lower Indus Valley about 200 miles NNE of modern Karachi, in the north part of Sind province, in what today we know as Pakistan.

TIME: some 4,000–4,500 years ago.

PLAYERS: a people, long since vanished from the area, but with increasing evidence that they were the ancestors of the populous dark-skinned peoples of today's southern India: the Dravidian speakers of Tamil, Telugu, Kanarese, Malayalam.

ACT I: fade from the ruins we see today, and known to us as Mohenjo Daro, back in time to one of mankind's first experiments in urban settlement – we do not know by what name its inhabitants called it – where the city fathers meet to accept the plans of their chief urban architect for the world's first urban sewer/drainage system: a network of gravity-gradient open ditches, into which all liquid-born wastes would flow off to same final place of out-of-sight/ out-of-Mind.

ACT II: there never has been an ACT II. Ever since Mohenjo-Daro, except for putting the sewer and drainage system underground and treating the effluent so that it commits less aggressive harm against neighboring communities, we have been in the rut of the very primitive duck bill platypus, stuck using a cloacal system to handle the quite different wastes from toilet (septage), bath and laundry (gray water), kitchen, and industry. Lessons for the "New Towns" of Space Except in "new towns," it would be prohibitively expensive to switch to a new 'multi-treme' system which keeps different types of sewerage separate from the beginning in order to benefit from simpler and more efficient source-appropriate forms of treatment, with the fringe benefit of enjoying whatever valuable byproducts such separate treatment may promise. Lunar and

space settlements are "new towns". Infrastructure is 'change-resistant'. Therefore it is of supreme importance to choose it wisely from day one.

While in many other areas NASA has chosen to pioneer radically new technologies, the agency, and those involved in the 1977 Space Settlement Systems Summer Study, turned instead to existing urban models when it came to the basic architecture of plumbing and sewerage treatment systems. If you think of the opportunities for Earth-side spin-offs, this decision emerges as a major slip-up.

Let's explore the benefits of an alternative triple conduit or tri-treme drainage and routing system for future off-planet mini-biospheres.

- 1) Farm, garden, and lawn run-off, food processing waste and kitchen garbage disposal waste (if not saved to compost for home gardens): the water laden with them should be kept separate by a distinctively labeled and color and/or design-coded drain and conduit system. After sieving out larger chunks for composting, such water can empty into fish tanks without further treatment.
- 2) Gray water from showers, hand/dish washing, and laundry would similarly have a privileged routing system, to a treatment facility which would remove whatever biodegradable soaps and detergents are allowed, for composting separately. The remaining liquid could be run during dayspan through shallow near-surface ponds, top-paned with quartz, where 'raw' solar ultraviolet would sterilize it, killing all pathogens and bacteria. Simply cleansed and purified with the biodegraded cleaning added back in, this nutrient-rich water could go directly to farming areas and into the drip-irrigation system.
- 3) Septage (urine and feces) can be handled next in several ways. The familiar very water-intensive water-closet flush toilet system could be preserved, connected to its own drainage net. Solids could be removed to be channeled through an anaerobic digester for composting and methane production [see "Methane" below], and suspended particles in the waste water treated by microbes to produce milorganite type organic fertilizer. The clarified effluent would then go to the farm watering system. Or, the urine and fecal water might alone use a third drain line system, while fecal solids are 'collected' for separate treatment. [See "Composting Toilets" below].
- 4) Industrial effluent must be purified and reused in a totally closed on site loop with a high price for any loss-makeup water piped in. Allowing industries to discharge water, of any quality, into the public drains system, invites passing on cleanup costs to the public. If all industries must play by this rule, and cost out their products accordingly, there will be no problem with this make-or-break provision.

The 1977 NASA study recommended the use of a wet-oxidation (euphemism = incineration) process for treatment of all water-carried wastes indiscriminately. While this method almost certainly offers the swiftest turn-around for our costly original investment of exotic (= Earth-sourced) hydrogen, carbon, nitrogen, and possibly added phosphorus and potassium, on the order of 1-1.5 hours, it misses valuable and elegant opportunities to produce 'organic' fertilizers and other regolith-soil amendments far superior to chemicals in their buffered slow-release of nutrients and in soil conditioning character.

In smaller space and/or lunar outposts, heavy reliance on chemical assistance for fast-cycling sewage treatment may be the only feasible way to go. But as we design settlements for hundreds or more pioneers, we have the opportunity, if not the duty, to consider more natural alternatives. Every part of our proposed tritreme drainage and sewage treatment system, has separately received abundant proof of concept on Earth. **MMM**

MMM # 43 April 1991

Living with The Moon's Own Rhythms



DAYSPAN By Peter Kokh

For the watchers on the ridge, it begins with an arcing flame of light punctuating the still dark eastern horizon -- part of the solar corona, something that the atmosphere-coddled Earthbound can never see, except during locally exceedingly rare 'total' solar eclipses. The Sun's intense disk is now still below the horizon, but this great prominence announces its imminent arrival onto the moonscape.

Here on the Moon, the Sun rises with great deliberation. From 'first contact' when the first diamond glint of light from the solar surface itself breaches the horizon, until 'last contact' when the entire blazing disk has just cleared, the Sun takes sixty ceremonial minutes to make its entrance. For such is the slowness with which the Moon turns on its axis to bring the Sun into view. (On the fast turning Earth, this show is run through in fast-forward so that it amounts to no more than a two-minute skit.) Two hours later, the Sun will have cleared the horizon by only a degree. It will not reach the far horizon, 180 degrees away, for another 14 3/4 days, better than two weeks.

But already this first standard day of the new sunrise, there is a noticeable shift in settlement activity and a quickening of its pace. Within a few hours of first light, solar panels and/or solar dishes, and the many sun-tracking, grabbing, and channeling heliostats will have all locked on to its life- and energy-giving rays.

The Sun is both workhorse and taskmaster for the little community. With its return, added electrical power surges online. Solar furnaces melt charges of raw, or refined, regolith for the productions of sundry items from cast basalt, ceramics, glass, and glass-glass composites or Glax™. The concentrated rays are also put to work sintering iron fines scattered abundantly in the loose regolith blanket, and collected with a simple magnet, into assorted useful pieces using powdered metal technology. And either directly through focused heat, or indirectly through electricity, industrial-strength sunshine begins cracking water reserves back into hydrogen and oxygen for use in fuel cells aboard field vehicles and, stockpiled until sunset, for reserve night-span power generation.

"Make hay while the Sun shines!" Not only does the pace of mining, processing, manufacturing, and field activities such as construction, road building, and prospecting, rise dramatically, but so does that of farming and home sunspace gardening. Plants emerge from their 'subsistence diet' of reduced artificial lighting during the nightspan, thrive anew and resume their progress towards eventual harvest. For most of the base personnel or settler population, the tempo of life has significantly accelerated.

More people venture abroad, "out-vac", either for work or just for a welcome change of scenery, excursion vehicles being popular choices over cumbersome spacesuits. "Selenologists," still lazily called 'geologists' by their Earth-tied colleagues, venture out of their labs to collect fresh samples in the field.

Habitats and pressurized common spaces (the "middoors") are flooded with soul-warming sunshine, thanks to the heliostats, which filter out both the unwanted heat of the infrared and the harmful fury of the ultraviolet rays. Stained glass and prisms turn sunbeams into a painter's palette and interior and middoor surfaces take on a new glory. Walls, finished with a cheap whitewash of CaO lime or TiO titanium oxide suspended in a waterglass medium of hydrous sodium silicate, make an ideal canvas for these rainbow-bright live paintings. Greenery, its verdant hues more vivid after 'breakfast', completes this characteristic settlement color scheme.

Oases of park space tucked into crannies of the various food-raising areas are thronged during free time. Schoolyard recess is imbued with renewed spirit. Those going to and from work along pressurized passageways lined with carefully chosen plantings seem to smile with a subtle new radiance.

Any ship carrying tourists will arrive while the Sun illuminates the area. Perhaps most of the visitors will stay to experience the full rhythm of settlement life, and depart during the following dayspan some three or four weeks later.

Long forgotten is the ho-hum grudging routine of daybreak on Earth, oft' equated with life before coffee. Here the Sun's glorious presence transforms everything through and through. For the fourteen plus 24-hour days of dayspan, the life of most settlers will be one of especially earnest industriousness. In every field of dayspan-reserved activities, there will be important production goals to meet if these brash settlers are to "set themselves up" for the quite different, but complementary, routine to follow. **MMM**

NIGHTSPAN

NIGHTSPAN By Peter Kokh

For the previous two plus weeks, this unlikely pocket of humanity on the Moon has been a beehive of activity, making use of the Sun's heat, its life-giving rays, and its electrical generating potential, to work through the more energy intensive portion of the long list of tasks needed to keep the community going. For total available on-line power will drop measurably as the Sun finally reaches the western horizon.

While the light available on the surface will remain full-strength until the final two minutes, 'down below' the level of redirected sunlight will have begun to taper off the past day or so as heliostats on the surface, even arranged in purposely staggered rows, begin to eclipse one another, cutting off solar access.

Industries dependent on harnessed and concentrated sunlight will have been located to avoid this problem, so they can keep working on full throttle for the full duration of 'sun-up'. Finally, however, the great solar furnaces and turbines will be shut down and the activities they support will stop. Those industries that depend indirectly on abundant electricity generated by solar arrays must likewise phase down. For whether supplied by standby nukes, fuel cells, spinners, or hydroelectric generators (where rille or crater slopes allow the possibility of pumping up water surplus by dayspan to let it fall during the nightspan), the total amount of on-line electrical power will be likely be appreciably reduced for the fortnight to come. Industry after industry will switch gears, taking up now the rather more labor-intensive tasks that it had strategically postponed during dayspan.

Maintenance, repairs, and changeout of equipment; assembly and finishing; packaging for shipment; bookwork and inventory – for many workers, it will be rather like switching jobs every two weeks. And perhaps that will be a welcome break in the routine, an anticipated and appreciated periodic shot in the arm, an essential element in sustaining personal and communal morale.

Workers who by dayspan crew those industries that do not have a proportionate list of postponable energy-light labor-heavy tasks to keep them busy during nightspan, might shift to quite different company co-owned ventures that are task-lopsided the other way. Unneeded farm workers might move to food-processing duties etcetera. Continuing education, especially in the line of one's work, might be preferentially scheduled for nightspan.

The Sun now set, Lunans, temporary personnel and permanent settlers alike, will find more leisure time for arts and crafts and cottage industry pursuits. Music, dance and other performing arts will vie for attention. Now there may be more time for shopping and flea market barter. Perhaps only necessities will be bought and sold during dayspan when able persons are best occupied building up export inventories to defray import costs, and producing domestic items to reduce import demand.

Fresh new pioneer recruits may have arrived shortly before sundown. This will give them a taste of what dayspan settlement life is like, saving more intensive orientation for the

nightspan when extra senior personnel will be freed up from other duties to devote themselves to this task.

The public spaces of the settlement – its mid-door squares, streets, alleys and passageways – might be more crowded during nightspan with people free to linger leisurely and enjoy activities for which there was little time the two hustling weeks before. Such places will come alive with entertainers and soap box orators, artists and craftsmen selling their wares or demonstrating their talents and taking in serviceable but prosaic “issue” items for customizing makeover into items of pride, hucksters selling similar items on commission, secondhand stalls and exchanges for recyclable items, shelves of produce harvested from in-home gardens and specialty jars of preserves put up by enterprising home-canners – you get the idea.

Ambience provided by electric lighting can take several forms. Great electric lamps might use those same sunshine-delivery systems slaved to heliostats during dayspan to provide periods of simulated daylight each nightspan ‘day’, with subtle mood-setting lighting for nightspan ‘nights’ (night life and sleep time).

And color? Colored bulbs as well as stained glass diffusers and dividers will be one way to provide a magically cheerful touch. A harvest of neon and other noble gases adsorbed from the Solar Wind to the fines of the Moon’s regolith soil blanket, and recovered by heating during the routine soil-moving processes of mining, road building, and construction, could lead to ample and creative use of neon lights. The “Greek Isles” look of the community’s middoor and indoor spaces, in which sunlight splashes whitewashed walls accented with luxuriant greenery, will be upstaged now by quite a different enchantment after dark. It seems unlikely that our future Lunans will fear the night!

At last, the end of the long nightspan will draw near, and the final evening meal of nightspan may become a special one in settler homes, filled with anticipation, maybe even ceremony: “Sunrise Eve”!

<<< MMM >>>

Will Lunans mark the days by the Month or by the



SUNTH By Peter Kokh

It should be clear from the above pieces that the arrival of sunrise and, a fortnight later, of sunset will radically determine the scheduling of almost every activity within a lunar community beyond eating and sleeping and making love. Given that most Lunan industries and enterprises must stop to shift gears at both sunrise and sunset, it will be of no small benefit to their efficient operation to schedule “weekend” breaks so that they always fall at the same time in relation to these all-transfiguring events. As the Lunar settlement will be “under the gun” to produce enough exports to balance the cost of needed imports, as well as enough domestic goods to minimize that import need, achieving such smooth operation is not a goal to be dismissed .

But here’s the rub. Sunsets repeat every 29.5 days (twice every 59 days) or 12 times a year with 11 plus days left over. The Jews and Moslems have such a calendar of “lunar months” (a tautology, when you think of it). But the Romans, while inappropriately keeping the word, altered the “month” so that an even dozen fit in each solar year. For us on Earth, where the really significant repeaters, affecting business cycles as well as agriculture, are the seasons whose onset is determined by our annual orbit around the Sun, quite irrespective of the lunar phase of the moment, the solar “month” (how that grates!) makes sense.

If the word “month” is no longer ‘honest’ for our calendrical tomes of 28–31 days, neither does it fit the sunrise to sunrise period on the Moon itself. From the viewpoint of one on

the Moon, it is the Sun's aspect which is significant. Hence our suggestion, [MMM #7 JUL 87, p. 9 "Calendar"] that the term "sunth" be coined for the purpose. Astronomers use the term lunation, but as this properly refers to the new moon to new moon period (that is, reckoned from local sunrise at 90° East), it is not sufficiently generic, and again inappropriately refers to the Moon, not the Sun (we would accept Lunar Solation).

Back to our question. Will future Lunans mark the days by Earth's months or by the local sunth? Perhaps they will use both calendars, side by side, or a special calendar with dual dating. To visitors from Earth, as to those serving temporary tours of duty with no intention of staying for the rest of their lives, the Earth date will be the "real" date, as if our arbitrary notation were some cosmic fact. Even "tory" settlers (those who have made the move in body but not in spirit) will feel reassured by a glance at our familiar Gregorian calendar.

Meanwhile, not only will settlement life totally ignore terrestrial conventions out of practical need, but both exports and imports and the arrival and departure of tourists will pay heed to the local Sun angle (the time of sunth) rather than to the date on Earth. Business and accounting cycles for Lunan entrepreneurs will follow the march of sunths, not months. Even those businesses on Earth trading with the Moon will need to refer to the lunar calendar (or at the lunar phases shown on most 'normal' calendars) to help determine shipping times.

From the 59 day sunth-pair to a full "lunar" calendar is a big step, however. For adopting a twelve sunth year of 354 days would put Lunans out of synch with Earth. IF they decide that this is not important, they have three basic options. A) they can simply let their 'years' (or 'calendars') advance over Earth years without any attempt to make an adjustment, as does Islam, giving it 33 years to our 32, or B) they can add an intercalary thirteenth sunth every second or third years, as does Judaism, or C) let the differences accumulate and add 7 extra sunths at the end of every 19th year (conveniently, there are precisely 235 new moons every 228 calendar months). If this last option seems far out, it does present a neat opportunity for a once-a-generation built-in period for institutional and cultural review. Those extra seven sunths could be collectively be called "renaissance" or "renewal".

IF keeping in sync with the year as reckoned on Earth is to be desired, sunths could be numbered 1 to 235, rather than named, in a cycle repeated every 19 years, while the year began and ended in lock step with the familiar Earthside cadence.

However the solar year/sunth incongruity is handled, using the sunth to mark the timing of events and activities within the lunar settlement will mean abandoning synchronization with the Sunday through Saturday rhythm so ingrained in us that we assume the day of the week must be a primeval cosmic framework valid in the most distant corner of the universe, even predating it, as some fundamentalists would insist. In fact, not only is the length of the day a purely Earth-local matter of no cosmic significance whatsoever, but the pegging of names to days in a certain suite with a once and for all calibration, is, however traditional, 100% arbitrary. Nonetheless the week, as it has been handed down to us, is the most stubbornly ingrained piece of our "cultural infrastructure" and has survived all attempts to tamper with it.

Making the switch to sunthtime, if pursued in earnest, will mean pegging 'weekends' to this beat, i.e. an integral 4 weeks per sunth, i.e. no leftover days, with each sunth starting the same day of the week. But in every 59 day sunth-pair there are 3 days more than an even 8 weeks. An adjustment can only be made by making 3 weeks out of every 8, 8 days long instead of 7. If each of these extra days was placed to make a long weekend, and used for all holiday observances, this would provide 18 holidays a year, quite in line with American practice, but in a non-disruptive format. A "leap hour" every six or seven 'weeks' would keep the 59 day rhythm from drifting, as the sunth is some 44 minutes longer than 29 and a half days.

To avoid confusion (Monday on the Moon while it is Wednesday on Earth, at least this week etc.) Lunans will most likely adopt a totally new set of 7(8) names. The previous MMM article alluded to above, has some creative suggestions for the pioneers.

Another major question to be settled is whether all Lunan communities will observe the same weekend schedule, no matter how many 120-wide 'date-zones' they lie apart from one

another, or whether local week-ends will fall with local sunrise and sunset. There are strong tradeoffs and they must weigh and choose.

Such a culturally radical switch in time-keeping would neither be to the point on Earth, nor stand as much chance as a snowball in a supernova. However, Lunans will be living in a workaday environment quite unlike anything ever experienced by any Earth bound community to date. For many settlers, the need to declare cultural as well as economic independence from Earth may be strong. In some form or another, Lunans will adopt conventions of time reckoning that pay only loose homage to our week and month. The year will survive, however, not because the Moon shares the Earth's orbital motion around the Sun, but because the two worlds lie in each other's backyard, assuring a high volume of trade and real time communication*.

I think it will be culturally refreshing! - MMM

MMM # 47 JULY 1991

NATIVE BORN

We can't wait to see if the Moon is "safe for children". Until we're sure that the 2nd native generation is healthy and fertile, we won't know. Delay will be self-defeating.

NATIVE BORN By Peter Kokh

In the recently ABC-aired Disney movie about a pioneer lunar mining settlement, "Plymouth", the central drama was the emergency dilemma of whether to return a pregnant pioneer to Earth, risking the unborn fetus in a high-G descent, or to allow her to bear a child on the Moon that might never be able to survive on Earth. Indeed, birth of the first human offspring outside the womb-world (Birth Squared!) will be a momentous milestone, easily eclipsing any mere demonstration of hardware and technology. If we are to build a system-faring civilization, sooner or later pioneering humans must forsake a return to Earth and begin to raise families, to live and die in space. As obvious as that seems, many of us cling to pathways of realization that are most unlikely to allow such a natural development.

There are pro-space people and there are pro-space people. The conservative peer-conscious shadow-fearing space-proponents who abound in high places see space as an arena for technology demonstration and ascendancy, for national prestige, and yes, for exploration, robotic and even human. They do not see it as a place for out-settlement, for a cradlebreak from Earth. That's something left to Trekkie fandom and other wild-eyed crazies like ourselves.

As long as our frontier-blazing activities are guided by the official wisdom of politicians concerned first and foremost with covering their butts with their similarly fretful and risk-shy constituents, it's hard to see how such a decision to go ahead with a pregnancy and birth on the Moon could every be sanctioned. Those who are not personally accepting the risk cannot be expected to have anything but a distorted perspective. And so there will be calls for many years of animal experiments, to see how they survive, mature, and breed, and if their offspring are fertile - above all to see how well Moon-born animals survive the return to Earth. But getting our feet wet, experimenting with real humans by allowing them to do what comes naturally - heavens forbid! [No! Heavens demand!]

It is the pioneers themselves who must accept the risks, and who can be expected to welcome them fearlessly. "Plymouth" is realistic in that official sanctions and taboos will sooner or later be ignored or foiled, and secretly or not, the first human child will be conceived and born in a lunar outpost with everyone a part of the conspiracy to keep it secret until it is too late to foil. Sometimes it is necessary to force an issue with a fait accompli. Politicians like mules, beg to be hit between the eyes with a 2x4.

The problem is, as “Plymouth” brings out so well, getting over the hurdle of trepidation and endless what-if worryings to cross the threshold of commitment to settlement – not outpost or garrison – settlement. In the rebellious tradition of the Heinlein who wrote “The Moon is a Harsh Mistress” and the erstwhile Bova who wrote “Millennium”, there must come a time when the pioneers seize their own destiny, and accepting all risks, knowingly plunge ahead, consciously burning their bridges behind them. While the first child–birth off Earth will be a real milestone, the underlying assent to destiny by the pioneer community will be The Milestone with a capital M. This is a step no colonizing Earth government is likely to advocate or bless. Indeed aversion to such a development may be treated as a litmus test of political correctness on the part of pioneer candidates, in government efforts to avert such a turn of events.

As to animal tests, experiments with small creatures with relatively fast life cycles, using artificial fractional gravity in orbital facilities, should give us an early indication of any potentially show stopping disorders of physiological development under Moon–like conditions. These are unlikely, to say the least.

But in last analysis, we can’t know for sure if the Moon is “safe for children” until we bear them there, watch them grow up and mature and have their own children, and see how well the second native–born generation does. For some undesirable traits might not show up until then. Some 20 to 40 years into the commitment to settle, the verdict will be in. For most of us, it is simple a matter of choosing to believe the most favorable outcome. The pioneers who choose to go and gamble with the rest of their lives and those of their yet unborn children, will be of like mind. There is no short–cut from here to there. “There is only do”.

But why should this daunt anyone? After all, we are all involved, every last one of us, in a similar high stakes gamble that we can continue to exist as a technology using species in long–term harmony and equilibrium with our host planet – something we can’t know for sure without the risks of trying.

Will native–born Lunans grow tall and lithe? I don’t know. Americans of our day are much taller than our ancestors, but because of a change in diet rather than gravity. Will Lunan children and the adults they become be muscleless featherweights? This is unlikely. For mass and momentum remain the same. The likelier outcome is that musculature will be different, not less.

What about cardiovascular circulatory systems? It will take less heart to pump blood from legs to head, but the same amount of heart muscle to power exertion in work and sports. So there might be a problem with the inactive child and sedentary adult, but not likely with those whose physical life is full.

Lunan sports will likely be new creations rather than caricatures in sixthweight of sports familiar to the Earthbound. Such sports will play to the peculiarly lunar mix of one sixth gravity and traction versus full normal momentum. Isometric exercises will be more important than weightlifting ones. Will the attempt, by those wanting to leave Earth return options open, to retain hexapotent (Earth–normal) muscle tone result in grotesquely exaggerated physiques, at least by the new Lunan aesthetic standards?

Certainly the image of the ideal male and female physiques will shift dramatically as the new native born generation comes of age and becomes numerically larger than the immigrant population. Miss Luna and Mr. Luna will not likely appear on the same stage with Miss Earth and Mr. Earth. The pretentious Miss and Mr. Universe pageants may disappear.

Lunan standards of grace will show themselves in new dance forms, popular, ballroom, and pseudo–classical and modern ballet. You’ll be able to look at someone and know at once if he is a native–born Lunan, but that s/he is human, there’ll be no doubt.

After the first few years of settlement–with–children on the Moon, there will be an interesting suspense about puberty and adolescence, but hardly any surprises. The first real drama will be the rate of healthy births to native–born Lunans. How many miscarriages will there be? How many complications in childbirth itself? How many malformed infants? How many retarded? These are all risks that will have to be faced and willingly accepted.

There are those who feel that after eons of evolution to the tune of Earth-normal gravity, Earth-life cannot adapt. But the whole history of evolution is one great saga of adaptability after another. That we have not adapted to another gravity level is simply because the challenge of doing so has not faced us. Our prediction is that it will be no problem. The worrywarts can stay on their 1G space colonies.

But gravity is not the only thing about which there might be legitimate concern. The mix of trace elements in lunar regolith and the agricultural soils derived from them will be subtly different. There may be deficiency diseases preventable by mandatory intake of dietary supplements and vitamins manufactured on Earth. There may be some level of chromium-toxicity, varying in seriousness from locale to locale. Careful choice of a settlement site considering agricultural needs should prevent severe incidences. Will there be any late-blooming consequences? Probably nothing outside the wide range of dietary variation on Earth.

Again, we must resist the temptation to cater to the perpetually fretful, to those unwilling to cross the mental threshold from the idea of human presence in space to the idea of true human out-settlement beyond Cradle Earth.. Have children we must. And if unlikely medical or genetic disaster does occur? We will have tried. That will be our badge of honor. [Editor's Comment 2005: In the end, the courageous decision to go ahead with pregnancy, childbirth, and the raising of families will be done only in settlements that are founded outside the sponsorship of governments, especially "democratic" governments who must answer to risk-averse public opinion. One of the unintended consequences of democracy is the eventual rise of gut-lessness, the tail wagging the dog.]



BEFITTING FUTURE SPACE PIONEERS

FUNERALS By Peter Kokh

To date, no one has died in space, though at least ten (Apollo 1 and Challenger) have been killed on the way up and at least four (Soyuz 1 and Soyuz 11) have been lost on the way down. Sooner or later some-one will meet his/her end in space, and unless the nature of the death makes the remains unrecoverable, be brought back to Earth for burial with full honors.

The first such deaths are likely to be individual or group accidents due either to mechanical failure or to human error or carelessness. Sudden natural deaths will also be possible. As the numbers of people in space grow and the off-planet community becomes ever more and more typical of human society, crimes of passion and even calloused murders of convenience will occur. Slower acting diseases will take their toll, even after early diagnosis, as people decline passage home "to die." Some deaths will be in the line of duty, even self-sacrificial. Others will have no apparent "meaning".

From time immemorial, countless numbers of people have met death and been laid to rest far from their homelands. The sea has claimed hundreds of thousands or more. Many a sailor and explorer lies beneath some marker on an inhabited shore on a distant island. Some have even been vaporized in nuclear explosions and scattered forthwith by the four winds. But never has a person been born, who has not been reclaimed by the bosom of our womb world, Earth.

There is a steep psychological threshold here. Commitment of a person's body to "the void" or laying his/hers remains to rest on some alien planet, moon, or asteroid will burst the envelope of our sense of "world". We will have been forced to integrate sterile off planet horizons with those of our fertile parochial oasis. If we define WORLD not as the arena of human life provided by the surface of our home planet, but as the continuous set of horizons

within which humans live, work, and relate to one another, such a baptismal integration of our planetary circumsolar hinterland into the human world will become natural, easy, and inevitable. Laying someone to rest 'out there', or on the surface of some other world or worldlet will consecrate that place forever more as a human place.

How the remains of an explorer, pioneer, or traveler will be disposed of will depend upon circumstances. On long deep space voyages, it will be natural to follow naval tradition and commit the body to the "Void". When storage of the body is convenient and the deceased's preference is known, internment can await arrival on the planet, moon, or asteroid of destination.

On Mars, traditional burial or cremation are likely options. But another interesting possibility – once the pioneer settlement is advanced enough to make it handle the logistics – is to lay the body to rest atop mighty Olympus Mons (75,000 feet high) under a canopy of UV resistant glass (to prevent blackening of the flesh) and allow it to freeze dry or desiccate naturally in the near vacuum and deep cold beneath the ever-shining stars – a "desiccatorium".

But on the Moon and similar volatile-impoverished worlds where, a) there is an established pioneer settlement encradled in a tightly recycling biosphere and where, b) volatiles are of communal economic necessity considered "rented" not "owned", options will be more constrained. A settler of means, whose estate can afford the replacement cost, at current market-deter-mined values, of the exotic/precious elements invested in the body and who so desires, should be able to be "wastefully" buried Old Planet style. While this should be legal, there is no guarantee that one's fellow settlers will not look on such a choice as obscene and insensitive. Instead the common course will be cremation, with return to the "atmospherule" of CO₂ and water vapor.

As to the unconsumed ashes, even though they are not as precious as the C, H, and N which constitute the bulk of the body's mass, are a resource still. Again, it should be legal to place them in an urn for placement in a private or communal memorial repository. But a more popular and acceptable choice may be to have them spread on a communal memorial garden – not a garden of vegetables, but one of flowers, with no purpose but to add color, scent, beauty, and an island of peace to the pioneer community.

What if someone wishes a more utilitarian disposition? The settlement is very likely to contain experimental agricultural plots where new and improved Moon-hardy varieties of vegetables, cereal grains, herbs, medicinal and dyestuff plants are being bred and developed to improve life on the frontier. Having one's fertilizing ashes spread on such non-production experimental gardens might be another choice for disposition with full honor and due respect.

"Dust thou art," etc.

Personally, I prefer a re-rendering of Genesis to read

"Stardust thou art, and to the stars thou shalt return!"

The point is we are of the Biosphere and the Biosphere shall reclaim us. On our cradle world where the elements our bodies incorporate are everywhere in profligate superabundance, there is no injury to "the plan" in delaying decomposition by either burial or mummification. However, in the tiny biospherules that we'll need to reencradle our existence on volatile-scarce worlds, there will be some real urgency to dust to dust reinvestment. "Banking" one's "rented" constituent elements for generations by traditional burial would be profligate waste, with a high toll on the shared cost of living on adopted shores.

For those of you with substantial means (count me out, but I wish you didn't have to) stuck against your will here on Earth, it now becomes an option to plan your estate to include a trust fund that would pay to have your remains (cadaver, or at least ashes) transshipped to the Moon when the day finally arrives that a frontier biosphere has been established there. Whereupon your elements can add to the infant biosphere's sweet air and fertile soils to contribute to the infant settlement's prospects of prosperity. Why not?

Death is a Fact of Life spelled with a big F. Yet to transcend the finality of one's mortality one only need contribute, create, produce – in short develop one's own talents – thereby investing in the community of one's survivors, – be it only anonymously, be it only fleetingly –

rather than just dissipate one's years consuming and spectating. We can do so too by rearing and educating, however informally, and so bring life and light to those who will carry the world (new expanded sense) forward when we are gone. It is in choosing how we will extend the significance of our lives beyond their apparent ends, anchoring them in the community at large, that we find identity and give our lives meaning. It is no surprise that those who never give a moment's thought to such concerns also never find themselves, never grow to know who they are. And so it will be on the Space Frontier as well. <<<MMM>>>

MMM # 50 November 1991



On the Space Frontier

TREES By Peter Kokh

Recently, a student working on the NASA grant Genesis CAD [computer assisted drafting] Project for Lunar Base & Habitat Design at the University of Wisconsin–Milwaukee's Department of Urban Planning and Architecture, produced an interesting plan in which his base offering was capped by a dome "to give place for trees". A NASA auditor excitedly protested that there was no way we could afford to waste space in such fashion. The student, unabashed, replied that if there were no trees, it would not be a human place, a place fit for human habitation; he stuck with his design.

This little anecdote illustrates a real dilemma. If we can afford to set up a lunar base at all at today's pre-SSTO [single stage to orbit] prices per pound to orbit etc., it may have to consist of sardine cans with perhaps an inflatable annex or two in concession to the need for elbow room. Even if the costs of space transportation fall, spaciousness will still be at a premium until we begin to build added expansion shelter from building materials processed on site (in situ) from lunar resources. This will require getting such technology out of the current laboratory curiosity stage, hopefully before we return to the Moon and start scratching our heads (is anyone listening out there?). The practicality of in situ architecture would be greatly enhanced if we could locally produce low-C [carbon] sealants, to keep import costs down.

But even with new on-line Lunar architecture, pressurized areas will tend to be close-ceilinged, without tree-scale headroom, or more; for the Nitrogen needed as a buffer gas to pressurize extra volume will be a costly import, that is, prior to large scale Helium-3 mining which will yield, hydrogen, carbon, nitrogen, and other precious gasses as byproducts. Of all the "lunar-deficient elements", or LDEs, nitrogen is in shortest supply in comparison to need, the choke-point for lunar operations – not hydrogen as is commonly believed. (Hydrogen, from Earth or Phobos/Deimos, is best shipped as Methane CH₄, or Ammonia NH₃.)

The student's observation, however, is quite on target. Without trees, we'll have only a caricature of human place, despite the fact that in some desert and plains areas, people do now live without them. Trees have played a critical role in the very appearance of mankind. Arms first became differentiated from legs, to the point that bipedalism was the next step, through brachiation, their evolution to fit the needs of simian predecessors swinging through the rain forest.

Much later, trees supplied poles for making shelters, and first allowed us to master rivers and coastal waters. We felled trunks over narrow streams and eventually milled them into bridges. We “dugout” trunks for our first boats, accelerating not only fishing and trade, but giving birth to fishing villages along ancient now-drowned coastlines (end of ice age rise in sea levels). Such villages likely well-predate the better-known agriculturally-centered villages of the bronze age. Trees have been a far more shaping element in our remote past than ever was the cave. In short, if we ever do come up with an “all-human coat of arms”, the tree deserves a place of honor in that design.

All this is over and above the function of the tree in Biosphere I. Second to oceanic algae and phyto-plankton, Earth’s forests make the greatest contribution to the sweet oxygen necessary to all higher life forms, single cell on up. Forests, even smaller groves of trees, help moderate temperatures, making many areas on Earth more livable. Finally, even lone trees produce shade and serve as place markers.

What place will trees have in baby biospheres? Their dedicated use for ornamental or landscaping needs would be an exorbitant luxury in off-planet towns until the constraints mentioned above are removed. The fragrance of blossoms and the reassurance of luxuriant greenery will instead be provided by smaller plants earning their place through food, fiber or pharmaceutical byproducts, all while naturally recycling exhaled carbon-dioxide into fresh oxygen, and filtering out airborne pollutants that can’t be avoided.

Yet, for settlement agriculture, trees remain a highly desirable asset: they’d add greatly to the variety of fruit, syrups, pulp, fiber, and artstuffs etc. – purposes that are less easily satisfied by smaller plants or bushes. Happily, tree “dwarfing” by nursery breeders serving home gardeners has made much progress. Prospects for settlement farms to feature short but fruit-laden apple, orange, pear, peach, and cherry trees (to name a few) are really quite good.

Beyond that, there is one radical proposal to grow nothing but ultra-fast growing trees on lunar or space settlement farms. Called ARBORCULTURE, this scheme would harvest the trees for pulp to feed vat-cultures of microorganisms, which would transform this fodder into synthetic foods of every imaginable taste and texture. Someday that pseudo Soylent Green may well be the most efficient way to do farming on the space frontier.

Meanwhile, living BONSAI miniature trees can provide nostalgic ambience for the early pioneers. The Japanese have long cultivated the art of dwarfing trees for room decoration. By controlled pruning and fertilization, trees are trained, not bred, to grow in small pots into caricatures of older, bigger trees. Evergreens, leafy deciduous trees, vine and fruit-bearing varieties are all successfully miniaturized. Settlers can grace their private quarters with them. Room/area dividers can consist of shelf-rows of bonsais. Waist-high set-back platforms in passageways can be lined with them. Mini bonsai forests can adorn unused spaces. Pioneers needn’t wait to bring along this quintessential human cultural symbiote. MMM

MMM # 51 December 1991



FIRE DEPT

FIRE DEPARTMENT By Peter Kokh

Fire and Man go back a long time together. A natural phenomenon frequently caused by lightning striking tinder dry forest, brush, and grassland, our ancestral domestication of fire for

cooking, heating, artcraft, and manufacturing purposes played a role in the rise of civilization hard to exaggerate.

Yet fire out of hand or out of place has been one of the most devastating and frightening perils to life, limb, and property. Our response to this danger has been one of fire codes attempting to both minimize the chance of accidental fires and control the spread of fires once begun. Most every community is served by a paid or volunteer standby Fire Department. In most cases, unwanted fires are quickly controlled and potential damage limited. Smoke, and other volatile combustion byproducts of fire, are quickly dissipated by flushing to the circulating winds of the vast atmospheric sink surrounding us.

Alas in settlements beyond Earth's atmosphere, the volumes of air available to absorb fire gasses, smoke, and other particulate byproducts will always be most severely limited in comparison to Earthside. Instead of an atmosphere miles deep above our abodes and over vast thinly populated rural areas, we are likely to have only the few cubic meters per person within pressurized habitat, food growing and work areas and other common places. Even in relatively voluminous megastructures like O'Neill colonies or the Princeton rille-bottom double vault span design, the available "middoors" common volume will still be so minimal by Earth standards that we will have to forgo a strategy of merely controlling fire.

Having nowhere to flush the smoke and fumes, a settlement that has even a small, quickly controlled fire may face at least temporary wholesale abandonment, the incident a catastrophe out of proportion with previous human experience. Instead, settlers will have no choice but to adopt a **zero tolerance for fire**. Their first line of defense will not be an automatic fire suppression system, no matter how elaborate. That can only provide a damage control backup and a futile one at that, simply buying time needed for orderly evacuation to standby vehicles or shelters. Rather spacefolk must accept **settlement design strictures all but guaranteeing that fires can't start by accident, and that set fires have nowhere to spread**.

Because most combustible materials are organics or synthetics rich in carbon and hydrogen, two elements scarce and exotic on the Moon, lunar towns and early space settlements built principally from lunar materials prior to the eventual accessing of cheap volatile sources elsewhere (Phobos and Deimos, asteroids and dead comet hulks] sheer economics will force the choice of largely inorganic and incombustible building materials, furniture, and furnishings. Commonplace wood, paper, organic and synthetic fabrics, and plastics will become exorbitantly expensive choices reserved for the obscene consumption patterns of the ultra-rich. In their place will be various metal alloys, ceramics, concrete, glass, fiberglass, and fiberglass-glass composites (Glax™). Even electrical wire will, for economic reasons, be manufactured on site with inorganic sheathing in place of commonplace plastics. Frontier houses and other structures simply will not burn.

On the Moon, the low gravity ("sixthweight") will greatly reduce the need for cushions, pads, and mattresses that cannot be easily made of these available incombustible inorganic materials. Early Space Colonies will thus have a second incentive to choose lunar standard gravity rather than Earth normal (the first reason being to allow much tighter radiuses, greatly reducing minimum size and structural mass, significantly lowering the threshold for construction).

The two areas of greatest remaining concern will be clothing and drying or composting agricultural biomass. Cotton, since its lunar sourceable oxygen content is much higher than any that of any other fiber choice, renders it easily the least expensive selection. The need to recycle its carbon and hydrogen content upon discard of items made from it, will mandate processing choices for cotton that are organic and thus happily preclude additives with toxic combustion products. The best strategy may be to isolate (even in fabric and clothing shops) concentrations of cotton fabrics and garments from one another in relatively small caches, each guarded by a sprinkler.

Biowaste and biomass management and housekeeping practices, combining strict personnel training with discontinuous storage in small concentrations below critical mass (but again with one-on-one sprinkler vigilance) should all but banish chances of spontaneous

combustion and make the spread of set fires impossible. Special attention must be given to grain and powder storage housekeeping and management.

IN SUM: on the early space frontier, fire “control” departments will provide no security. If a fire big enough does break out, the game would be already lost. But what if, despite all precautions, the unthinkable does occur?

Fire shelters connected to the community by airtight fire doors and relative over-pressurization could be provided, doubling as shelter in event of pressurization loss. However such shelters must be large enough to accommodate the entire community on a short term basis. It may be prudent to design the community with enough fully “isolatable” storage and warehousing space or agricultural space to serve emergency needs. For the only way to recover from a fire may be to depressurize, then repressurize the affected area. Since a fire may well leave no option but retreat, there should be periodic en masse orderly evacuation drills for the community at large.

As the constraints on building materials ease through cheaper out-sourcing from Deimos and Phobos and/or asteroids and comets, the taboo on using organic and combustible synthetic materials for in-settlement structures, furniture, and furnishings must not be relaxed. In most space locales we will never have the luxury of enough contained ambient atmosphere to allow a return to our current flush it and forget it strategy.

On Mars, in contrast, thanks to the thin carbon dioxide atmosphere and available water and ice reserves, pioneers should be able to produce inexpensive wood and plastics with almost Earth-like ease. Yet here too, until the far off dawning of some new age of “terraforming” that installs a planet-enveloping commonwealth of breathable air, human settlements on Mars will labor under the same threat of sheer disaster from even the most minor of fires as will lunar and space settlements. If the Mars settlements are to allow wood and synthetics, it will be wise they do so with constraints that work to isolate them in discontinuous small pockets.

Economics on Earth has made the abandonment of combustible materials unthinkable. Instead, fire is tolerated and we have “Fire Departments” for “control” . Beyond Earth, quite different economic realities will combine with a major exacerbation of the threat posed by fire to make fire truly intolerable, and a strategy of control futile. There won’t be any Fire Departments in space frontier towns. <MMM>

EVERFRESH

EVERFRESH By Peter Kokh

A strange thing happened on the road to energy conservation after the first oil crisis in the late 70s. Totally insensitive to the micro-sources of air pollution and the need for their co-management along with the thermal control that had our full attention, people all over the winter-experiencing world began tightening up their houses. A problem that we never knew we had because it had been effectively neutralized before, suddenly emerged. Both houses themselves and the activities of those within them generate substantial amounts of domestic air pollution. Happily, in our anything-but-tight construction methods of the past, these indoor pollutants along quickly enough dissipated through cracks and openings to the “outside” along with warmth bearing “stale” air to be replaced with cool “fresh” air from the Earth’s generous atmospheric envelope, whose transcendental ambience and carrying capacity we all take for granted.

As we buttoned up our homes and office buildings to conserve heat and reduce the need for heating fuels and/or electricity, we also dammed up a river-flood of indoor air pollutants, a river with many tributaries. Suddenly, for those who had spent good money to make the “improvements”, their indoor air was significantly more polluted than the “outside” air to whose declining quality we had all become sensitized.

Fortunately, there has been an “easy” sweep-it-under-the-rug solution: air exchangers that trade inside air for ‘fresher’ outside air but make a thermal swap in the process. There has been much less attention, unfortunately, to genuine and radical solutions: getting rid of sources of indoor air pollutants in the first place. It is a story of shortsighted economics and simple convenience.

This experience does not set us up well for future life on the space frontier. Beyond our womb-world, we will not have any all-enveloping placental atmosphere to keep us blissfully cozy. Each settlement will have to contain and conserve its own “atmospherule”. There will be no “outside fresh air.” There will only be “inside air”, and in the cases of megastructures like O’Neill cylinder and Stanford torus space colonies or Bova/Rawlings Moon Plaza and LRS’ Prinztown vault-spanned lunar rille-bottom villages, a very finite amount of “middoors” air that simply cannot be used as a dump sink.

A “charter-concern” of off-Earth “xities” will be to maintain air freshness within those limited confines. We can’t allow the air to get stale in the first place!

Building materials and furnishing materials that have high outgas flows when new (new car smell, which is nice so long as we can control its intensity by opening the window or vent) will be taboo, to be replaced by those with tolerably low outgas flow rates. Fortunately the offending materials are all organic or synthetic, something that cannot be economically produced on the Moon nor in nearby space settlements dependent early-on largely upon lunar raw materials; and the cost of upporting them out of Earth’s gravity well may continue to be a prohibitive economically-suicidal luxury even if transportation rates fall. Equally happily, the building materials that we can produce on site (metal alloys, cast basalt and ceramics, concrete, glass, fiberglass, and glass composites) are all inorganic materials with significantly lower outgasing.

Synthetics cannot be avoided altogether and for pressurization sealants and lubricants, as much attention will have to be paid to the their outgasing contribution as to the percentage of native (lunar-sourced) content (oxygen, and silicon for carbon substitution). To our knowledge, no work is proceeding along these lines, though undoubtedly, by serendipity, research to date must have uncovered promising avenues for further exploration. But enormous mountains of “filed: no economic use” research data must be “mined” to get at these clues. And space supporters who work in the chemical and petrochemical industry are the ones that have to be motivated to do the necessary detective gumshoe work.

Of late, we have all become aware of a new source of indoor pollution – radon, produced in the Earth’s crust by radioactive decay and working its way up through microcracks, some of it eventually into our basements. Again, in the era of looser homes, this was a problem below the threshold of concern. The potential for radon problems on the Moon are unknown. But the general rate of radon seepage is one of the things that ought to be weighed in the process of base or settlement site selection. But perhaps we ought not to be overly worried as the both the relative extreme over-pressurization of lunar habitat space (in contrast to lunar vacuum) and the attention to sealants and leak detection that will be in force to maintain and contain pressurization (the expense of replacing leaked atmospheric nitrogen, exotic to the Moon, being the 2x4 poised to strike between our eyes) will work to force crustal radon to find other avenues of escape.

Then there are the pollutants that come from life activities: housekeeping, food storage, cooking, laundry, and personal hygiene. In the lunar or space settlement kitchen, the need to minimize rather than dissipate odors, the need to minimize aerosol oils production (if you’ve ever lived with anyone whose culinary skills are limited to frying, you know only too well what a problem this can be), and the attendant humidity control problems poised by steam will all force major changes in the way pioneers prepare food. Frying will be a no-no as will, of course, be barbecuing.

Open boiling will also be taboo. Even the oven will be frowned upon. But that does not leave us with a diet of uncooked and/or cold foods, though the proportion of these will probably strike a healthier balance. There remains the friendly food-zapper, provided the

concerns of some about microwave emission dangers prove unfounded. But, when taste and flavor are more important than convenience, there is an old standby waiting in the wings, now largely in disuse: the old-fashioned pressure-cooker, tops for speed, flavor, texture, and odor and steam control.

A word about barbecuing; while domestic BBQs may be taboo (there being no "outside" porch or patio but only tightly controlled and policed "middoor" ones) specially licensed restaurants with their own separate and expensively recycled atmospherules may offer char-broiled steaks, ribs, and chicken – if the meat can be found for an affordable price!. Eating there will be much more expensive than dining in the most expensive five star French restaurants here on Earth.

A companion problem, not to be treated lightly, is storage of food. On Earth, we consider that if someone doesn't mind accumulating preserves of spoiled produce, meat, and leftovers in their pantry, cellar, or refrigerator, or pay attention to the control of in-house food waste composting systems, that is their problem. In the closely shared finite air supplies of off-Earth settlements, it will be everyone's problem. The low priority now given to education on good housekeeping practices will need to be drastically altered. The same goes for accumulations of unwashed soiled clothing.

Bathroom odors are a separate problem, treated in "Composting Toilets" ["Compostlets"] in MMM # 40 above. But for these and cooking odors that can't easily be reduced below a stubborn minimum, a system of stale air 'sewer' and 'drainage' ducts from key localized areas and eventually exhausting into agricultural areas for natural refreshening, will constitute a unique new xity utility service.

The problem of humidity-control must be addressed. In the limited shared atmospherule, plant transpiration will produce excess humidity, a potentially severe source of mold and mildew. Dehumidifiers will be the logical source of the fresh water supply, organically dirty but chemically clean used water being used for irrigation in a natural cycle. Priority attention will have to be given to dehumidifier housekeeping to avoid such things as potentially community-wide outbreaks of Legionnaire's Disease.

Next in concern are household cleaning and surface maintenance agents. Many of those in common use on Earth are far too aromatic and far too productive of air pollutant aerosols to be approved for space frontier use, domestic or commercial. In some cases, a light adjustment of formulation may remove the offending characteristics. In other cases brand new or discarded old substitutes will need to be found, or rediscovered. Happily, the challenge posed by today's tightened homes will gradually promote the appearance of acceptable alternatives by marketplace economics.

Even outdoors, we've all on occasion encountered the person who has either chosen to mask the odors of neglected personal hygiene, or compensate for a self-image of inadequacy, by using enough perfume or cologne to make a French harlot seem puritanical, notifying all within fifty feet of his or her approach, even in a stiff wind. On the space frontier, aromatic intensity of available cosmetic preparations will be tightly controlled, most of those currently available on Earth will be contraband. A stress of personal hygiene and attention to more subtle ways of personal image building will have to substitute.

And smoking? Without a profligately generous atmospheric fresh air sink all about, public smoking will be totally taboo, and private smoking allowed only in spaces, home or private club, expensively provided with quarantined separate air recycling systems.

We've all met people with green thumbs, whose homes or apartments are a delightful jungle of live greenery. While most everyone likes a few house plants about, what would commonly be seen as "overdoing it" will be the standard in lunar and space colony homes, a cultural norm that doubles as a natural psychological defense response to settler awareness ever just below the attention threshold, of the stark barrenness and sterility of the absolute ultimate desert from which they are separated by the settlement's pressurization containment. It will be a norm carefully fostered by deliberate education. House plants aid in keeping the

inside air fresh both by recycling exhaled carbon dioxide and by filtering out airborne pollutants, some plants doing a better job of this than others.

The challenge of mini-biosphere maintenance begins at home, inside. For on the frontier, "outside" is only vacuum. It is one thing that will characterize xity life as drastically different from Earth-normal city life with its laissez-faire attitudes and happy-go-lucky lack of concern. <MMM>

MMM # 52 February 1992

XITIES

Beyond-the-cradle off-Earth settlements ("Xities") will be fundamentally different from the familiar Biosphere- "I"-coddled "cities" that have arisen over the ages to thrive within the given generous maternal biosphere that we have largely taken for granted. Elsewhere within our solar system, each xity must provide, nourish, and maintain a biosphere of its own . Together with their mutual physical isolation by surrounding vacuum or unbreathable planetary atmospheres, this central fact has radical ramifications that must immediately transform space frontier xities into something cities never were.

In this issue, we investigate a gamut of essential xity functions, some familiar but strongly redefined, others new and without precedent, and their demands upon the structure of xity bureaucracies, government, and politics. <MMM>

Xititech

Xititech By Peter Kokh

While heretofore in human history many departments of cities and towns (health, light and power, streets, traffic, parks, schools etc.) have at least some number of professionals with germane expertise on their payroll, the policy distorting interference of elected politicians, patronage appointees, and job-secure civil servants more often than not has the upper hand. No matter how poorly citizen needs are met, no matter how "unlivable" in relative terms urban areas may become, people survive. Gaia, the Earth's mothering biosphere, even in the extremes of its climatic crescendos and geological catharses, is relatively friendly even to the shelterless.

Whatever may be the case some distant day out among the stars, anywhere else in our Solar System hinterland that we might eventually establish pockets of civilization, the hostile host environment will not be so forgiving of task-bungling in the name of self-serving interests. Unlike cities, "xities" must be run largely by professionals and technicians if they are to remain "livable" in a sense that is starkly absolute.

To illustrate, consider the department structure likely to be found in any xity government. But lets go backwards in order of significance to our thesis, that is in order of most familiarity to present day terrestrial urban area experience.

Xity SCHOOL Systems

In this country at least, we have an enormous tolerance for mediocrity and outright failure in our schools. After all, our society (as distinguished from the Japanese, for example) is one of atomic individuals whom we deem responsible for their own success or failure. "God helps those who help themselves" etc. We put a low priority on bettering the odds individuals

must face. As a result, we are inexorably becoming a second class nation by all per capita (as opposed to gross) standards of measurement. But we will survive.

On the Moon, Mars, out among the asteroids, or in space colonies in free space, clusters of humanity will be so much more challenged by both high thresholds of economic viability and the fragile vulnerability of all but “sink-less” mini-biospheres. They cannot hope to long survive unless they collectively see to it that their citizenry is appropriately educated on all points on which their continued existence tightly clings. With one on one attention if need be, they must be prepared to accept a much higher level of individual and actively cooperative responsibility for their “commons” [whatever cannot be privately owned like the air, waters, and the environment in general and for which no one therefore seems individually accountable or responsible].

Along with other subjects, each must learn well the facts of mini-biosphere life and the workings of biosphere support systems in enough detail to appropriately affect their individual micro-economic decisions as well as their environment-relevant housekeeping habits both public and domestic. Useful in building appreciation and respect for the city’s potential failure modes would be a universal service system in which each student would at some time do yeoman stints on the farms, in air and water freshening and biowaste composting utilities, in discard collection and recycling chores, and on pressure-integrity maintenance crews. Because their existence will be far more critically dependent on technology than even our own, they cannot possibly be either good enough citizens or enlightened voters if the rudiments of science and technology are treated as electives as is common practice Earthside. [See “the 4th R”, MMM # 34 APR ‘90., MMMC #4]

Such education will be most effective, of course, if appropriate incentives and conveniences to proper action are built into city systems. We are too used to passing ordinances without thought to making compliance easy and natural, if not second nature. (If you outlaw spitting on the sidewalk, you should provide handy spittoons, etc.) That will have to change if cities are to succeed against the enormous odds. Living downwind and downstream of themselves, city-dwellers will be especially prone to choking fatally, en masse, on the business-as-normal by-products of daily life.

Barring censorship, a poor solution, space frontier citizens, settler and native-born alike, will likely be reminded or exposed to the saturation point with television and videos depicting everyday life in Earth cities under conditions so relatively forgiving as to permit general inattention, dismissal, or even contempt for the commons. In frontier cities, schools will have to sweat up an especially steep hill as a result.

Future Lunans, Martians, Belters, or Space Colonists may not be able to order the latest fashion design, kitchen convenience, or electronic gizmo from the Sears catalog, or go to their neighborhood K-Mart or area mall lined with specialty shops featuring everything under the sun. They may not have supermarkets with an infinite selection of prepared convenience foods, toy outlets featuring plastic incarnations of the latest cartoon heroes, bad guys, and monsters. Nor will the current fare in chic throwaway fascinations Earthside be available.

Instead young and old alike will have to be prepared for the crude, make-do substitutions of the frontier. This will strongly motivate settler artists, craftsfolk, and entrepreneurs to make and produce improved and refined goods that from production to ultimate disposal respect their fragile mini-biospheres and the recycling systems that help make them work. At the same time such new wares will help build a do-or-die long-term trade surplus (see below) by ever working to further defray “upports” from Earth and expand total exports.

One can imagine the curator of the local museum selecting for the “Reminiscences of Earth” hall, principally ethnic folk and frontier items that, even if not appropriate for space frontier situations, demonstrate encouragingly the best in human resourcefulness under challenge. By contrast, the latest carefree titillations for individual convenience will be well enough represented by film and video.

Xity HEALTH Department

Space frontier Health Departments will be charged with more aggressive attention to public and domestic housekeeping conditions that could promote the spread of any pests that slip through space transportation safeguards (food cargoes pressurized in 150° F nitrogen, or exposed to vacuum; settler screening and clothing trade-ins etc.) But here again, education will be primary.

Public **health dollars** in the U.S. grease the squeaky wheel. Thus much more attention is given to keeping the no-longer productive person alive, than in ensuring that the young do not grow up so unhealthy as to later burden the system. Space frontier settlements will be hard pressed to survive unless a much higher fraction of their populations are productive than seems acceptable on Earth. So priorities will be turned around with emphasis on expectant mothers, infants, children, and seniors with good years left in them. In respect to the latter, the emphasis must be on improving quality of life, not on extending it for extension's sake. Bear in mind that in very isolated space frontier settlements, xities may be really xity-states, concerning themselves locally with cares here left to the state or jockeying candidates for national office.

Development of all-new Sports will be a new concern for xities, or for associations of xities sharing similar gravity/inertial situations. For most of the traditional sports we now enjoy will transplant poorly. [Jai Alai is one possible exception]. But Earth-return physical and physiological rehabilitation programs might well be left to free enterprise.

Department of Social Services

For reasons already cited, when it comes to Social Welfare, the xity's "first line of defense" must be before-the-fact prevention rather than after-the-fact assistance or outright neglect (not only in third world cities, but of our own urban address-less). The universal if never stated presumption on Earth that, if need be, people can survive fending and foraging for themselves, will be an all too obviously unthinkable one within the confines of mini-biospheres quarantined from one another not only by miles, but by hard vacuum and radiation or unbreathable planetary atmospheres. Again the stress will be on education and training to be flexibly productive.

Department of Economic Diversity and Trade

Nowadays, increasingly strapped American cities are taking a much less laissez-faire attitude towards their industrial and commercial bases. For xities, this will not only be a way of countering economic decline as they age, or to promote new and refound prosperity, but a matter of sheer survival. In point of fact for Earthbound cities, as the nations they drive, a negative trade balance with the outside can be sustained for a surprisingly long time – though tolerated slippage in the standard of living, and/or reversion to "simpler times" – read more direct reliance on the support capacity of "Mother Earth". And through income redistribution bandages, areas that lag badly, can be propped up by those enjoying better times.

Neither recourse is likely beyond Earth-orbit. Xities will either ever re-justify themselves economically, or they will end up being abandoned, sooner rather than later. Xities, and associations of xities sharing the same planetary or space setting, must through publicly supported means, endeavor to ensure that local entrepreneurs find ever new ways to turn local resources (or other raw materials more cheaply accessed than shipment up the expensively deep gravity well from Earth) into new products for domestic consumption to reduce the need or pressure to upport from Earth, or into products for sale to Earth, Earth-orbit facilities, and to other off-planet settlements, in sufficient volume to fully pay for whatever upports and other imports that the xity cannot (or prefers not) to do without – and to do so with reserve-building surplus.

A **xity university**, however modest by today's standards, would be a logical agency to promote industrial and commercial diversification, even helpful new arts and crafts. The university could do ground-breaking materials use research and then assist entrepreneurs in development of marketable products for some limited share in the royalties.

To support this diversification, xities on planetary surfaces (Moon, Mars, larger asteroids, etc.) will support continuing development of the potential economic geography of their hinterland surroundings. This will mean establishing satellite outposts (some of them

perhaps to become rivaling xities in their own right) in order to add to the mix of minerals and raw materials upon which economic diversity rests.

Space Colonies, each more like Singapore than analogs of giant Japan (a comparison frequently made), may bind together in leagues to better exploit asteroidal and cometary resources. The goal will be to lessen the restriction of their economies to industries supportable by a diet of lunar raw materials alone. This need to establish and continue a favorable trade balance will drive an initial handful of surface and space xities ultimately to develop much of the Solar System, whether Earth itself remains interested or not.

An **Office of Strategic Materials and Import Protocols** could employ some blend of taxation and credits to ensure that strategic materials in short supply (e.g. on the Moon: hydrogen, carbon, nitrogen, and metals other than iron, aluminum, titanium, and magnesium) were not diverted into spurious luxury uses or tied up in non-durable products without efficient fast-turnaround recycling systems that work.

It will be also be in the xity's interest to maximize **interxity trade** so that together the xities are not just financially self-supporting but also industrially and agriculturally self-sufficient if ever Earth cuts off trade, whether as a result of world conflict, major depression, isolationist politics, or the spreading of hostile fundamentalisms in the various world faiths. Such an ability to collectively survive the cutting of the umbilical cord to the womb-world must be the cornerstone of every xity-state's "foreign" policy.

Department of the Xity BIOSPHERE

The differences between mega-biosphere-contained cities on Earth and the mini-biosphere-containing xities on other worlds, as described above, while significant, may seem matters of stress, emphasis, and priority. We won't argue the point. But that's as far as one can stretch the kinship. No city on Earth must build a containment system, mega-structural or modular, for its atmosphere. Nor need any city on Earth concern itself with maintaining its own climate or the routine sequencing of its seasons (beyond the provision of air-conditioned skywalks and other structure-connecting passages, as popular perks).

No city on Earth must be dependent upon a closed loop water supply, drainage, and recycling system totally within its own limits (even island city-states like Singapore have the surrounding sea). In contrast, no xity will ever be founded on a coast or lakeshore or river or over a subsurface aquifer -

at least not until the "rejuvenaissance" [a coinage decidedly preferable in its connotations and the pathways it suggests to "terraforming"] of Mars is fairly well along.

A **Corps of Pressurization Engineers** will be charged with containment integrity and maintenance of the atmospheric pressure of the settlement within the desired limits. Ever vigilant for leaks and structural weaknesses, they will preventively repair microcracks, monitor the performance of sealants, and relieve structural stresses safely. Automatic detection devices and frequent human inspections will be crosschecks in preventing failures of regular airlocks, liquid airlocks [MMM # 17 JUL '88], and matchports [MMM # 15 MAY '87 - both included in MMMC2]. The corps' job will be different in megastructures such as O'Neill colonies, Bova-Rawlings' Main Plaza [Welcome to Moonbase, Ben Bova, Ballantine '88] or the double vaulted rille-bottom villages of the Prinzton design (LRS '89) from that of those charged with this most critical of all xity responsibilities in modularly constructed settlements with physical growth potential (banded and modular torus space colonies, the double helix oases [MMM # 11 FEB '88], and any of the more common Moon and Mars base proposals. Depending on the settlement's overall architectural plan, separated or separable fall-back safe havens need to be provided and maintained.

The work of the corps presupposed, the **Office of Atmosphere Quality** will be charged with maintaining air freshness and the proper mix of gasses: oxygen, nitrogen or other buffer gasses, and carbon dioxide.

The settlement may have some sort of baffling separating the agricultural, residential, and industrial areas. If so, the fans and ducts which provide for flow of fresh and stale air across these baffles without back flow, need to be maintained to preserve air quality.

The **Hydrosphere Office** will maintain the xity's water reserves and their cycling starting with the dehumidifiers that condense excess humidity from plant transpiration to provide fresh clean drinking water. The Office may maintain a tritreme drainage system [MMM # 40 NOV '90 "Cloacal vs. Tritreme Plumbing"] that keeps separate, for ease of treatment, sanitary waste water, gray water from washing and bathing, agricultural runoff, etc.

On the Moon, reserve water supplies may be shunted in a cycle through dayspan electrolyzers and nightspan fuel cells to produce power to complement off-line solar generators. Reserve water can even be cycled through closed-loop high head rille-side or crater-side hydroelectric stations, again to boost nightspan power [see MMM # 31 DEC '90 pp 4-5; also in MMMC #4].

But reserves can also be used to improve air quality by running them through fountains and waterfalls to mist and cleanse the air, and to add further to the quality of xity life in the form of canals and lagoons for boating, pools for swimming, and even trout streams for fishing.

Whereas some cities take upon themselves the task of providing and maintaining green markets by which produce from rural farms can be sold directly to city dwellers, in xities beyond Earth, under the Biosphere Dept., there will be a **Sub Department of Agriculture**, with far more responsibility than even national agriculture departments here on Earth. For in xities, the antithesis of farm and city will be resolved. The xity will contain major agricultural areas within its biosphere, not only for logistic and economic sense, but because the farm areas will play the critical role in the recycling of stale air into fresh. The composting of solid organic wastes will be its duty.

A system of parks, pathways, picnic strips and memorial gardens might well be integrated into portions of the agricultural areas adjacent to residential, industrial, and commercial zones. Since the emphasis will be on plants that serve an economic need, even landscaping and "streetside" plantings will be selected to fulfill a dual purpose. Thus the whole eco-system makeup of the xity biosphere's general flora will be under this sub-department.

Agriculture will also bear upon the selection of livestock (if meat-eating survives as an accepted lifestyle) and the xity's complement of urban "wildlife" (some species needed to make the ecosystem work, and maybe some others more for public enjoyment). This sub-department would also license allowable pets and enforce their reproductive control.

As serious a job as is running a major city in today's world, the burden of responsibility on the Xity Parents out on the space frontier will be much heavier. The very continued existence of the xitizenry will lie in their hands. There will be far less room for the discretionary nonsenses of political decisions, far more entrusted to the care of responsible technicians. This will affect not only the structure and divisions of xity bureaucracy but the roles of elected officials and how they see them.

These life-in-the-balance responsibilities may even require final abandonment of the dictatorship of the majority [our present system, wherein each faction attempts to gain a mere 50% plus advantage, in order to thrust some premature solution serving vested interests down the throat of any other equally non-cooperative faction] for governance by informed consensus. Government by co-"promise" not by compromise. The extraterrestrial xity will be a precedent shattering institution. And just maybe, Earth cities will pick up a few helpful pointers in the watching. <MMM>

On the Space Frontier, can there be any

FIRE **SIDE**

around which to gather?

FIRESIDE By Peter Kokh

Since time immemorial, ever since the taming of fire, humans have sought warmth, comfort, and company huddled around campfires and hearths. Even today, when a dwindling number of modern homes boast the luxury of a fireplace, nestling around the fire is something we all enjoy – when it is cold or damp, when we are out camping, on a clambake or a picnic in the park, or just out on the patio or in the back yard for a barbecue or marshmallow roast. And can any of us forget the bonfires after a high school homecoming football games?

While nowadays, such pleasures are scarcely everyday experiences, however infrequently enjoyed, the magic of the fire is so much a universally positive experience that it is still possible to ask: “can it be humanity if there is no campfire?”

In “FIRE DEPT.” MMM # 51 DEC ‘91, we pointed out the very intolerability of open fire, controlled or not, in the very limited atmospherules of mini biospheres. But that is not the last gloomy word, for it only applies to fires in which the combustion products are smoke and toxic gasses.

In MMM # 40 NOV ‘90 “METHANE” we discussed the possibility of controlled burning of compost-pile derived methane to produce water vapor along with CO₂ for plant nourishment. Such combustion will need to be confined to nitrogen-free chambers so as to avoid unwanted nitrogen oxide byproducts. Could such a methane-oxygen fed flame in a glass-faced chamber serve as a fireplace substitute? Why not?

It should also be possible to devise a tightly confined hearth “substitute” that slowly fed together pure hydrogen and oxygen. If again the burning is confined to a nitrogen-free chamber, the only combustion product would be steam – pure water, which can then be used for drinking or other purposes. In effect, we are talking about a modified fuel cell, in which the $2H_2 + O_2 = 2H_2O$ reaction is run somewhat faster, not so fast as to be explosive, but fast enough to sustain a flame, perhaps with a harmless enough additive (if one can be found!) to colorize the normally invisible H+O fire.

I’d be surprised if either such device now exists, with little market for them – down here. But out on the frontier, a flame-in-a-jar device might create enough symbolic warmth and cheer to become commonplace in settler homes on the Moon or Mars or elsewhere, in gathering spot lounges, even on long trips aboard spacecraft or surface roving coaches.

Why not tinker up such devices now? The methane version could not be used in draft-tight close quarters but a hydrogen hearth might sell to apartment dwellers, especially singles wanting the latest in trendy mood-setting gizmos. Just knowing that we could take such “**fire chamber**” with us, could make the prospects of life on the space frontier just a little less daunting, just a little more reassuring. <MMM>

MMM # 55 May 1992



MOON ROOFS By Peter Kokh

Roofs on the Moon? – where it never rains or snows? Ah, but it does rain – a gentle slow micrometeorite mist, and a steady shower of cosmic rays, plus sudden ‘cats and dogs’ outbursts during solar flare episodes. While the characteristically imbricated (tile or shingle overlap) shedding features of terrestrial roofs would not be called for, the sheltering function of

the 2–4 meters (6+ –13 feet) of shielding overburden above Lunar or Martian habitat space will be more than a little analogous to the familiar roof, a prehistoric heritage.

To the architect, the roof has traditionally been one of the most important opportunities for statement of style. To give some outstanding examples: the thatched English cottage, the terra cotta Spanish Tile roofs of the University of Colorado in Boulder, the green-patina copper roofs of many early urban skyscrapers, the onion domes of St. Basil's in Moscow's Red Square, the tailored French mansard, and the Pagoda.

It would be natural for future settlement architects in the employ of well-to-do façade conscious homeowners to turn to the shielding blanket as a clay for expression. And for those hired by companies seeking a striking design for their new headquarters building, to turn to lunar “roofs”, alias shielding, as a medium of style.

Already, purely for the utilitarian reason of simple convenience, some outpost designers are specifying that their habitats be neatly sand-bagged. The advantage of placing the loose lunar regolith in bags should be obvious. Not only will it keep the construction site cleaner – and safer (from dangerous bulldozer module collisions) – it will allow the bag-tamed shielding to be easily removed in order to repair hull and joint leaks, to make structural modifications, and to exchange old, or attach new, expansion modules. Meanwhile, by this simple trick of bagging, the external appearance of the outpost is drastically altered. The ‘lith-bagged outpost now looks like an on-surface installation rather than an under-surface one, its appearance and presence radically transformed.

An alternative to the bag or sack (which could be made on site from medium-performance lunar fiberglass fabric) would be sinter blocks made from compacted and lightly microwave-fused soil. By varying the size and shape of such blocks and the patterns in which they are stacked, distinctive igloo-like styles should be easily achieved.

Grecian Formula

It does not stop here. There is no cosmic law that states lunar shielding must be gray, or Martian shielding rust-hued. If desired, colorants can be added to the material itself, or glazed or even merely dusted on an exposed, rough surface.

In the early settlement, the availability of colorizers will not be great. On the Moon, Calcium Oxide, CaO, i.e. lime, made from highland soil will be a likely early favorite, probably cheaper than mare ilmenite-derived Titanium Dioxide, TiO₂, also white. Either way, “whitewashing” Lunar settlement shielding mounds might early on become “politically correct”, for they would make the settlement a conspicuous very bright spot on the Moon’s surface, perhaps even outshining the crater Aristarchus. This would make Earthlubbers more conscious, and hopefully supportive, of their frontier-blazing brethren above – a cheap way to put any Moon town in the “limelight”!

More than empty vanity

By the simple addition of shaping or sculpting or colorizing, the shielding mound will become more than a visual disturbance of the surface. The ‘lithscaper’s or architect’s touch can imbue the protective mound with design, unearthing the presence of the living and work space below and making the otherwise hidden structure visually present above the land-scape in an identifiable, pride-investing way.

This transformed self-image of the settlement may have real positive effects on the outlook, mood, and morale of the pioneers themselves. For it can be an early, easily won battle in a campaign to “humanize” the sterile barren alienness of their surroundings, thus contributing subtly to a sense of being “at home” in their adopted raw new world.

Economic opportunities

Indeed, outside of the occasional observation cupola, for most surface settlement habitat architects, the “roof” may be the principal opportunity for exterior public-side statement (other than any openings to also shielded public “middoor” spaces like pressurized roadways, passageways or squares etc.) But the opportunities for “roof”-styling will more than reward frontier architects. This market will also provide entrepreneurial openings for

enterprising settlers to develop the additives, the tools, the equipment, the processes, for making such on-paper possibilities real off-the-shelf choices.

Bower Roofing

Nor need 'roof adornment' be an expensive luxury item. For it could also serve as an at least temporary 'banking' outlet for otherwise hard to recycle used building materials and other non-organic 'debris' – perhaps in shredded or gravelized form – and for various orphaned manufacturing and mining byproducts for which more suitable uses are not yet in sight. These are two stubborn categories, which contribute significantly to terrestrial landfills, yet receive little if any attention. Here we could take a page from the bowerbirds (8 species in Australia, 8 in New Guinea) who decorate the interiors and entrances of their nests with "found" objects of all sorts.

Settlement Signatures

Without attention to shielding style, it could well become a prevailing truism that once you've seen one surface frontier town, you will've seen them all. Given human nature and the slightest modicum of discretionary private and public funds, it is unlikely that such will be the case.

Distinctive 'lithscaping and "roofing" styles may become characteristic identifying trademarks, not only of individual structures, but of different lunar and Martian towns taken as a whole. And there will be economic incentive, and payback, for the small expense involved in the form of tourist interest in "local flavor". Long before any Lunar or Martian towns become large enough to begin to grow small high-rise "downtowns", they may become identified in the tourist mind by their individual mix of "roofing" styles. And all it will really take is a wee bit of imagination! <MMM>

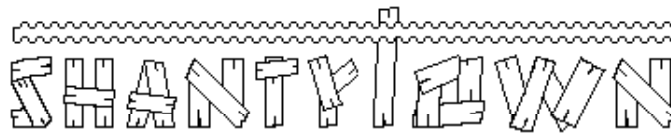

SHANTYTOWM By Peter Kokh

We opened this issue with an IN FOCUS discussion of a current brash proposal to unilaterally open the Moon, or a large part of it, to homesteading. In all honesty, only space within a biosphere can be ripe for homesteading. In that sense, except for the obscenely wealthy, homesteading will not be an early way to open the space frontier. Some territory that is to be made "homestead-friendly" must be opened first.

Nonetheless, there will be at least temporary imbalances in the supply and demand for private residential turf on the frontier. Like it or not, there will be displaced persons, hard pressed to use their ingenuity to hustle up secured privacy (if not shelter) – within a constructed and maintained biosphere – using "found" cheap, if not free, discarded materials or byproducts. There will be no outside ("out-vac") shantytowns hugging settlement walls. But there may well be cyclical or even persistent economic dislocation and quarterslessness within the containing biospheres of the Lunar or Martian towns and their early boom-bust economies.

To hide from this eventuality like an ostrich is not appropriate planning behavior. Rather, recognizing that this unfortunate sideshow of what we like to think of as mainstream human life might well follow us out into our new adopted extraterrestrial homelands, we ought to plan a gamut of strategies to deal with it. Barracks and dormitory space for newcomers, singles, estranged mates, and the elderly unwanted must be provided. The pace of public works outside the settlement, i.e. building new roads, outposts, supporting science excursions can all be speed up or slowed down as this labor pool grows or shrinks.

This said, there will still be those – hopefully only a few – who will be without proper personal quarters. But their numbers could rise in bad times faster than the public sector can

make provision or adjustment for them. Within-the-walls temporary shantytown areas could be provided on an emergency basis to take up the slack.

Shantystuffs on the Space Frontier

As with shantytowns on Earth, the building materials of choice will be those that are free for the taking. Discarded skids and crates and tankage and other packing and packaging materials stockpiled for eventual recycling could be drawn down for this purpose. Indeed it might take little in the way of cost or effort to manufacture such materials in the first place with an eye to this potential reassignment or diversion of use, making them shanty-friendly so to speak.

Many items will be co-shipped as “packaging” to the Moon with the expense debited to the C.O.D. cost of the packed items. The idea of choosing, manufacturing, designing and/or processing such “packmates” so that they are capable of diverse reuse, is one we have mentioned before. For example, we could choose to ship things in copper, lead, or other strategic “lunar deficient” metals that can be cannibalized later. We could choose to formulate packaging materials out of low molecular weight solid hydrocarbons that can serve as chemical feed-stocks, or out of compostable molded materials rich in the micro-nutrients that lunar soil typically lacks, etc.

Manufacturing common shipping “tare” items so that they can also serve as easy-to-assemble shelter components, shouldn’t be difficult. This process of adding extra features to make unrelated reuse simpler, easier, and cheaper is called “scarring”. Given the hidden exorbitant cost of importing such co-shipments, it’d be foolish not to invest the relatively minor cost of scarring them to leverage the bootstrapping of the settlement economy. And when and if the need for “make-do” temporary housing disappears, these items could either be recycled or made available to entrepreneurs who can transform them into elements for durable and attractive housing.

Deliberate shantytowns and worse cases

While we might hope that the need for all this proves to be minimal, it is on the contrary possible that some space frontier settlements, in the asteroids for example, may even be designed totally as shantytowns through and through. They would be set up to serve some temporary purpose, then fold up gypsy style, to be set up afresh in some new location.

Other space frontier towns, confidently designed and constructed as “permanent”, may suddenly find that the economic underpinnings of their survival have vanished through an evolution or revolution in technology perhaps, or through the opening of cheaper alternative sources of whatever they supply to the off-planet economy. If such a town has not moved early to diversify its exports, all or most of its inhabitants might suddenly become displaced. Without any alternate ways to hold on in “depression mode” until recovery measures can be realized, the need to shanty these people elsewhere may become urgent.

Differences from Earth

Hopefully, the minimal intra-biosphere shantytowns that do arise will not be totally dismal places. Even in the worst favellas surrounding our exploding third world mega-cities, it is possible to find pockets of art, design, and obvious pride of place. For it is not the materials that are used, but the care and imagination with which they are used that make such differences. The talents for blending composition, for artful juxtaposition, for cheerful accentuation with color, etc. etc. – these are talents that are rare. But they are also free.

Given likely high standards for settler recruits, these talents may be less uncommon on the space frontier. Shantytowns that arise out there, might prove welcome exceptions, exuding hope and promise, rather than despair and resignation.

Space Frontier communities will not be utopias – not in any social sense (despite careful preplanning for special challenges) nor in any materialistic sense. It will be a long, long time before life on the Moon, Mars, the asteroids, or in free space oases will be as sophisticated or genteel as in most any city on Earth. This frontier, like all those that have come along before, will be for those who thrive on the rough edges and cheerfully rise to the challenge of softening those edges, rather than those who need to find them already velvetized. And when this frontier

opens, those who value luxury, refinement, and being up to date or ahead of the Joneses, will do best to stay behind on Earth. Space will be an opportunity to tame and create and overcome and contribute and sew, not soon an escape for those who would only reap and consume.

MMM

AGRI-GARMENTS

By Michael Thomas, Seattle L5 Society

It is often assumed that due to the lack of hydrocarbon rich raw materials like petroleum and coal on the Moon, lunar inhabitants will be dressed in natural fabrics, particularly cotton. But this poses several problems, particularly for early lunar settlers. One is that there is little or no data on the feasibility of growing cotton hydroponically and early outposts will almost inevitably use hydroponic methods of food production. Another is that a large fraction of the cotton plant is inedible and otherwise useless. So only the cotton fibers themselves would be in demand. Early CELSS environments will prob-ably not be able to afford such wasteful agricultural choices.

Even food crops may need to be modified for CELSS agriculture. NASA researchers are already attempting to modify rice plants with genetic engineering so that they will provide more complete nutrition. Natural rice protein is deficient in some amino acids essential to human nutrition, but genetic engineering should be able to correct these deficiencies. A further goal of this research is to develop rice plants whose stems and leaves are tender and edible, so very little of the plant is nutritionally useless.

In related work, other researchers are pursuing similar goals, such as the development of a strain of corn in which the cob is tender, juicy, and edible, as well as the kernels. Such will likely be the fare of off-word hydroponic gardens, and this leaves little room for wasteful cotton production.

A further complication is the relatively complex and labor intensive process of milling cotton from raw bolls into thread, fabrics and clothing. There are several steps involved from harvesting to the gin to spinning threads and weaving fabrics, to the design, cutting and sewing of those fabrics into garments. Whether a robotic textile mill is designed, or one employs human labor, a good deal of machinery and energy are required to perform all of these steps. It is too complex and unwieldy.

So what is one to wear? Paper? It has been said that paper will be so costly in space habitats that books and other hard-copy documents will be rare and expensive. This may be correct, but I submit that cotton fabrics will be considerably more costly to produce.

paper: a **non-woven** substance made from rags, wood, or other fibrous material, usually in thin sheets, to bear writing or printing or for wrapping things, decorating walls, etc.

fabric: a cloth made by **weaving, knitting, or felting** fibers.

And we must not allow ourselves to be trapped into conventional thinking. Paper can be made of many different kinds of plant fibers. In fact, wood pulp paper is a very poor source for garment-grade papers. it is too hard, inflexible and it tears easily.

A fraction of such paper can come from plant root, stem and leaf fibers, but the bulk of such paper should have to consist of longer, stronger and more flexible fibers. There are several possible sources for such fibers. One is cotton fibers. Yes, I have spent paragraphs arguing against the use of cotton textiles, but I am speaking of much smaller quantities here and far simpler processing A paper garment need not contain more than 10% cotton, as opposed to 100% for all cotton garments.

Ant there are other possibilities that might be more economical than the use of cotton. In a CELSS environment. If any animals are raised for food or as pets, such as rabbits or cats, sheared fur could be used as reinforcing fibers in paper. Even human hair could serve this function.

Along other lines, researchers working for the D.O.D. have genetically engineered bacteria to produce spider silk. This silk is to be used in the production of bullet proof vests and flak jackets superior to those made of Dupont Kevlar™ today. This sort of fiber would be ideal for reinforcing and softening a paper made partially of vegetable fibers.

Even cotton fibers have recently been grown in a petri dish for the first time, without the wasteful bulk of roots and stems. It would likely also be possible for bacteria to produce cotton fibers, and long, cotton-like cellulose fibers to make a unique paper that is smooth, soft and flexibly strong like no other before: perfectly suited for making comfortable and reasonably durable garments.

Relatively primitive paper production methods would be easy to automate to a large degree, and garment production could be simple and standardized with a few styles to choose from. And since color fastness would not be required, relatively primitive plant dyes could be used in a form like water colors, to paint designs or artwork on garments. In fact garment painting could become a hobby or folk-art in which individuals are encouraged to participate and so express themselves creatively.

The paper itself could be made in various solid colors. Since bleaching by conventional chemical methods would be unthinkable, the base color of the paper might be some sort of off-white or manila color, depending on its exact contents. However, ultraviolet radiation might be of some utility as a bleaching method if white were desired in garments for special purposes or occasions.

On Earth, paper garments have been worn in Japan for centuries, and have enjoyed a couple of periods of brief and limited popularity in the west. I recall paper dresses being a fad in the sixties. More recently, paper jackets have been seen. Yet far more appropriate garment papers than those presently in use could be produced using exotic materials. Papers have been made with synthetic polyester fibers for clothing, ship-ping envelopes and other special uses.

But the possible range of unique papers made of many fibers for many uses is almost limitless and has been poorly explored at best. There is lots of room for work in this area, and it is possible that with fibers like animal hair, cotton and spider silk, papers could be made durable enough to survive several cycles of washing and wearing before wearing thin. (Most currencies are printed on such durable papers already, though garments would have to be considerably softer than dollar bills.)

In addition to clothing, various grades of paper could replace other fabric items such as bed sheets, canvas for paintings, draperies, table cloths, wall and furniture coverings, even shower curtains. <MT>

MMM # 63 March 1993

color the Moon "anything but gray"

COLOR THE MOON – ANYTHING BUT GRAY By Peter Kokh

"Blue moons" aside, the Moon is a very gray place. So much so that when Apollo astronauts stumbled on a small patch of regolith with a faint orange tint to it, there was a great deal of excitement on two worlds. If future lunar outpost crews and the settlers that eventually succeed them are to have any chance of keeping up their morale, they will need to see to it that their cozy pressurized safe havens against the magnificent gray desolation "outlooks" are literally alive with color.

For the initial outposts staffed by small scientific garrisons, the task will be easy. Their Made-on-Earth habitats will come vividly pre-decorated. But as settlement begins, based on the availability of shelter Made-on-Luna of lunar raw materials, colorization will have to be

arranged locally using coloring agents derived from on site materials. This will take a great deal of forethought and prior experimentation.

The principal avenues for introducing color on the Moon as in Space Settlements built mostly of lunar materials are these:

- 1) luxuriant green vegetation and colored foliage and flowers;
- 2) naturally colored cotton and natural organic fabric dyes that do not stress water recycling systems;
- 3) vitreous stains for coloring glass and glazing ceramics;
- 4) inorganic "paints" that do not tie up precious carbon or nitrogen; finally 5) colored "neon" lighting using noble gases scavenged from regolith-moving activities.

In this article we will deal with 3) and 4) above: inorganic chemical agents for decorating interior surfaces and to support a vigorous arts and crafts enterprise. The critical importance for keeping up settler spirits so that the populace can sustain overall high productivity, will demand that the processing of such agents be totally integrated, on a high priority basis, into the overall lunar industrialization strategy.

The bottom line is that those planning beneficiation suites and cascades needed to "stock up" the lunar industrial "pantry" with available "processed" elements, will have to pay as much attention to the production of coloring agents as to that of elements needed for metal alloys and glass and ceramic additives. Happily our chemical engineers will find that many elements desirable for alloying can also support colorization.

Stained glass and vitreous ceramic glazes

Staining glass and applying colored glassy glazes to ceramic ware both have venerable, millennia-long histories. New coloring agents have been explored and experimented with to expand the choice of hues, tints, shades, brightness, opacity, transparency, and ease of workability.

Lunar pioneers will find many of the choices we now take for granted closed to them – those that involve chemical elements that we won't be able to produce economically on the Moon for a long time to come or must instead be expensively upported out of Earth's gravity well. Those lunar-supportable choices that remain will yield **a distinctive lunar palette**. The order in which these agents become available will clearly mark "**periods**" in lunar decor. [Elements not easily produced on the Moon shown in italics]

REDS

Familiar agents that can't be produced on the Moon: lead chromate, cadmium sulfide, cadmium sulfoselenide, and manganese copper. Lunar chemical engineers will be able to produce the chrome, the sulfur, and the manganese, but will not too soon nor too easily come up with the lead, cadmium, selenium or copper.

Fortunately, aluminum oxide mixed 4:1 with ferric oxide Fe_2O_3 produces an attractive red. While lunar iron is mostly ferrous, yielding FeO , the ferric oxide can be prepared by controlled rusting of native iron fines from the regolith. A spinel, $FeO \cdot Fe_2O_3$, produces a darker red. A tomato red can be prepared from Uranium oxide, which can likely be found with known Thorium deposits.

PINKS

Lead chromate and chrome tin pinks are out – little or no lead or tin. Chromium-zirconium is a possible substitute. A manganese-alumina pink and a chromium-alumina pinkish red are other choices. Eventually, cobalt-magnesium combinations might produce a pink to lilac range.

ORANGES

Unsupportable lunar options are Uranium-cadmium and chromium-iron-zinc. Glazers may have to blend available reds and yellows.

YELLOW

The list of closed options is long: lead chromate, lead nitrate, zinc oxide, antimony oxide, red lead, potassium antimoniate, vanadium-tin. Instead colorizers will have to play with vanadium-zirconium and titanium-iron oxide preparations.

BROWNS

Unavailable will be the orange brown of copper-based $\text{CuO}\cdot\text{Al}_2\text{O}_3$ and the reddish brown of zinc-based $\text{ZnO}\cdot\text{Fe}_2\text{O}_3$. But in stock should be the reddish brown of iron chromate $\text{FeO}\cdot\text{Cr}_2\text{O}_3$, the Indian red-brown of magnesium-iron oxide $\text{MgO}\cdot\text{Fe}_2\text{O}_3$, and the red-brown manganese titanate MnTiO_4 .

GREENS

Out are chromium-beryllium, lead chromate, copper, and copper-vanadium preparations now in use. A blend of yellowing vanadium and bluing zircon in the presence of sodium fluoride (if fluorine can be produced, a difficult but high industrial priority) is an option. Praseodymium (from KREEP deposits) phosphate with a calcium fluoride additive is another. The deep emerald green of chromium oxide may be the standby. This could be blended with available yellows and blues to produce neighboring tints.

BLUES

My favorite color. If we can't do blue, I ain't goin'! Many blue ceramic stains use zinc oxide, barium carbonate, tin oxide, and copper phosphates. Fortunately cobalt aluminate yields a matte blue, and cobalt silicates and oxides produce mazarine blue, royal blue, flow blue, and willow blue. A titania-alumina blue, $\text{TiO}_2\cdot\text{Al}_2\text{O}_3$, with a corundum structure is a possibility but it is difficult to prepare by synthesis as opposed to starting with Ti-rich bauxite. Other choices include a vanadium-zirconia blue and a silica-zirconia-vanadia-sodium fluoride system of blues, turquoises and greens. I can go!

WHITES

Commonly used tin and antimony oxides will likely be unavailable. Instead, titanium dioxide, zirconium dioxide, and zirconium silicate seem the way to go.

BLACKS

Blacks have always been the most difficult stains to produce as there are few truly black inorganic agents. Instead we are left to blend semi-blacks with noticeable green, blue, or brown casts to them in hopes of neutralizing those tints and being left with apparent true black. Given the narrowed list of preparations available on the Moon for blending, coming up with a satisfying black will be especially difficult.

COMPLICATIONS

Making everything harder is the fact that the choice of flux affects the color outcome. Lead fluxes will be unavailable. While there has been considerable success in preparing lead-free glazes and fluxes on Earth, many of the substitute preparations rely on other elements hard to come by on the Moon such as zinc. Glazes based on feldspar (aluminosilicates of potassium, sodium, and calcium), alkalis (Na_2O , K_2O), alkaline earths (calcium and magnesium) with borax (hydrated sodium borate) will work. The trick is to find the boron. It seems absent in the crust but should be in the mantle. Central peaks of large craters may include upthrusts of mantle material and will be worth prospecting for this and other elements. Boron is a frequent major addition to many glass formulas as well.

Lead and boron make the best fluxes and if neither is available we may need to experiment with sodium, potassium, or NaK compounds. Waterglass, a hydrated sodium silicate and the only known inorganic adhesive is a possibility and it is on the must-produce list anyway.

None of the needed experimentation need wait upon our return to the Moon. Would-be contributors to a pretested distinctively lunar palette of glass-staining and ceramic color-glazing preparations need only religiously exclude at every step any of the coloring compounds based on lunar-scarce elements and concentrate on those likely to be produced in plausible beneficiation and chemical processing suites.

This is, however, a task that can occupy many people over long periods. They might establish a network and share the results of their trials and errors. Art styles that preview lunar settlement art will result, helping to promote the opening of the frontier by making its visualization more concrete and vivid. Future lunar settlers will be much in their debt for contributing greatly to their way of life.

Stained glass

As to working with stained glass, once we are able to produce it in a variety of colors, we face another problem. The individual pane-cells that go into a stained glass mosaic piece, are usually held together by lead caning. We'll either need a pliable and malleable lunar-sourceable substitute (a stabilized sodium-potassium alloy?) or we will have to bypass the problem. One approach may be to cement the individual pieces on a host glass pane using a waterglass type adhesive. If we want stained art glass dividers and Tiffany type lamp shades we will have to literally get the lead out, one way or the other.

Oxide pigments for waterglass suspension "paints"

Painting, in one form or another, has been practiced from prehistoric times. Lunar paints will return the art to exclusive reliance on inorganic oxide pigments, greatly reducing the available choices and again producing a distinctively lunar palette for home decor, art and craft use, and painting in general. Forget today's vivid coal-tar derived organic pigments. Forget the alkyd, oil, acrylic, and latex suspensions. Forget the organic solvents. All of these rely almost exclusively of carbon and nitrogen from the biosphere cycle, demanding replacements at high cost. Until the day carbon and nitrogen can be produced locally as cheaply as inorganic substitutes, formulators of lunar paints will have to rely on something quite different.

Perhaps the best candidate for a suspension medium is the only known inorganic adhesive, waterglass, a hydrated sodium silicate, ranging in formula from $\text{Na}_2\text{O} \cdot 3.75\text{SiO}_2$ to $2\text{Na}_2\text{O} \cdot \text{SiO}_2$ and as white powders or viscous-to-fluid liquids. MMM suggests preparing paints that are suspensions of lunar-sourceable inorganic oxides in waterglass. Unprocessed fine-sifted regolith dust can be added for graying the hues. Flecks of aluminum can provide a silver, and particles of FeS_2 , Pyrite (fools' gold), can produce a gold.

What about a canvas? That's an easy one. Try painting on glass. Flip the finished piece over or lay on another pane to present a protected face. For large expanse painting – such as walls – we could try titanium dioxide or calcium oxide (lime) water-glass based naturally flat whitewashes. While experimentation with lunar-repeatable glass staining or ceramic color glazing will be beyond those without access to a good chemical lab and considerable experience, trying out lunar type paints should be something quite a few of us could try.

We hope one or more readers will be inspired to take the plunge and thus advance us one big notch further towards a livable lunar frontier. Pioneers in lunar appropriate colorization, whether they ever set foot on the Moon or not, will have a special place in Lunar Settlement Prehistory.

BOTTOM LINE: to supply those who would add a healthy dash of color to lunar existence, processors, in addition to supplying elements present in abundance, must also isolate **chromium, cobalt, potassium, sodium, sulfur, vanadium, and zirconium.**
<MMM>

MMM # 64 April 1993

Flag Concept for a Future Lunar Frontier Republic



Grey (Moon's surface) **Yellow** (sunshine), **blue** (water) – or preciously harvested or expensively imported hydrogen with which to make it, and **green** (farms and gardens) of transplanted Earth species -- creating the mini-Biospheres that must cradle enduring settlements. Such a flag would help bring home to the Earthbound that the Lunar Settlement is Gaia-friendly. **PK**

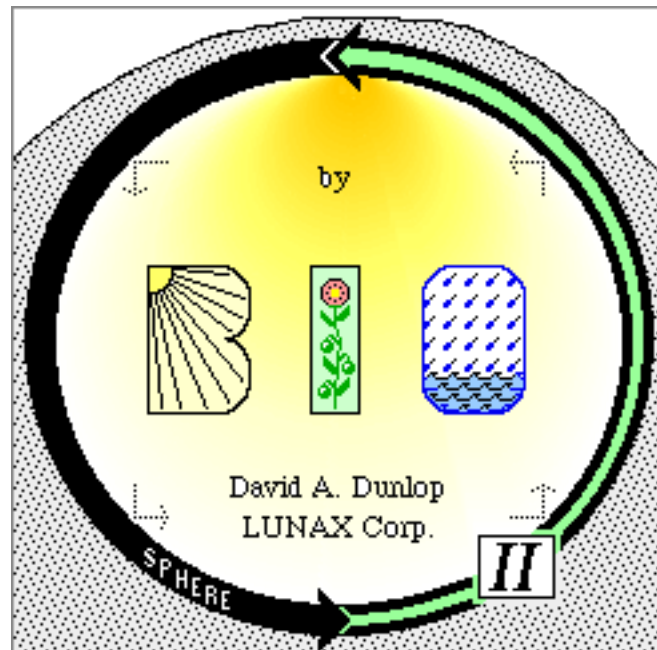

BIOSPHERE II By David A. Dunlop, LUNAX Corp.

“The National Commission on Space has reported that a highly reliable **Controlled Ecological Life Support System** is mandatory for extended space travel.” Maurice M. Averner -- NASA HQ

While it is often said that man cannot live by bread alone, it is also a truism that in space as everywhere else, bread is indeed a necessity. The Biosphere II project has a much more sophisticated goal than to merely produce a high degree of self sufficiency in food for long duration space flight. The Book "Biosphere II: The Human Experiment" by John Allen, Director of Research & Development at Biosphere II, provides a beautifully illustrated history of the project. I have abstracted much of the Biosphere II history and description from this volume.

The word biosphere, was introduced in 1875 by the Austrian geologist Eduard Sues to describe the "envelope around the planet which was inhabited by life". In 1926 Russian geochemist Vladimir Vernadsky published a volume entitled "The Biosphere" which offered a framework for the existence of a global ecosystem controlled by life. He argued that life was in fact a geological force shaping and changing the environment in which it evolves.

Later British Atmosphere scientist James Lovelock showed that Earth was unique in having an atmosphere with oxidizing oxygen and reducing methane at the same time – in sharp contrast to the atmospheres of Mars and Venus oxidized to over 95% CO₂, while that of Jupiter was reducing. He argued that life itself working on the physical-chemical processes had created an atmosphere particularly useful to life.

Lynn Margulis, an American microbiologist, worked with Lovelock to demonstrate the mechanisms by which the atmosphere regulates itself. They described the biosphere as a cybernetics system which is self-regulating by means of rapid microbial response to small changes in the composition of the atmosphere. They also showed how the atmosphere, through these biological feedback mechanisms, had evolved from one comprised largely of CO₂ with only trace nitrogen and no free oxygen, through the processing of anaerobic bacteria using hydrogen sulfide and releasing sulfur as waste, to an atmosphere with 16% free oxygen and 80% nitrogen with bacteria using water as their source of hydrogen releasing oxygen as they used the Sun's energy to combine hydrogen with the carbon from atmospheric CO₂.

The 'whole systems' modeling of Earth was discussed by Buckminster Fuller and many others during the 1960's and 1970's and planetary exploration provided more examples of planetary atmospheres in sharp contrast to that of the only planet with life. In 1961 Russian scientist Evgenii Shepelev began designing 'closed loop' biological systems to support cosmonauts in space.

American Claire Folsome created a closed glass sphere with seawater and a natural diverse community of the microbes that live indefinitely within the closed marine environment with only the input of solar energy. By the early 1970' the Soviets had developed larger closed system environments with higher plants, as well as algae tanks. By 1984 the Bios 3 experiment was the size of a small space station 315 cubic meters in size with a human crew tending its garden and algae, harvesting crops, and preparing the food they had grown.

The Russian experiments had shown that soil-less agricultural systems provided too few habitats for the microbes so vital in the natural environment of Earth. In Bios 3, gases emitted by the algae tanks proved toxic to the plants and trace organic gases built up over time. Essential trace elements were lost by the removal of solid human waste and plant material.

This theoretical and experimental history then was the foundation for the design of the Biosphere II that would attempt to seal several varied biomes into one enclosure. The closed system would include "designer" analogs of different natural biomes as well as a carefully designed horticulture and animal food production system. The environment would carefully monitor a variety of atmospheric gases and would be highly engineered to maintain a tight seal with a goal of 1% leakage per year and other sophisticated environmental controls maintaining temperature, humidity, and pressure.

The challenge was to establish and maintain the different biomes in close proximity to one another, and to supply the range of functional microbial suites necessary. It was also argued that small quarters for travel in space were not adequate to the requirement of a self-sustaining space habitat. Quantifying the volume of biomass necessary to use up all the carbon dioxide and make adequate oxygen from human crew consumption was attempted. To design adequate soil beds, a volume of "ocean", and the "right" communities of plants to provide a stable system sustaining not only the human crew, but also the plant, animal, and microbiology communities is the challenge of Biosphere II.

Departing from the Biosphere II project for a moment, I have quoted NASA researcher Maurice Averner in an article on Controlled Ecological Life Support System research. NASA's program dates to 1978 with the goal of supporting extended duration missions beyond the capability of the life support technology then existing. The CELSS concept is based upon the integration of biological and physico-chemical processes relying heavily on green plant photosynthesis to construct a system that will produce food, potable water, and a breathable atmosphere from metabolic and other wastes in a stable and reliable manner.

NASA research on CELSS is conducted at the Kennedy Space Center, Johnson Space Center and Ames Research Center. Other NASA funded CELSS research is funded at universities such as UW-Madison, Purdue, and previously the University of Florida at Gainesville, and Utah State University. In 1985 the CELSS Breadboard Facility was initiated at Kennedy Space Center. Comprised of a Plant Growth Unit, a Food Processing Subsystem, and a Waste Processing Subsystem, each component was to be tested independently, and then integrated, to

demonstrate the basic techniques and processes for a larger ground based system of practical size.

Simulation models try to define the parameters of air and water reclamation, moisture condensation and vapor-liquid equilibrium, contaminant control, and O₂ removal. Mathematical models of materials flow for monitoring CELSS performance, and related research, is intended to determine the effects of plant-microbe interaction on plant health, growth, food production, and regeneration of atmospheric gases.

The future thrust of NASA research will continue engineering and development. After the Breadboard Project will be a ground based unmanned CELSS. A gravitational biology research program will be conducted. The Space station will provide a vehicle for testing specific CELSS issues and hardware components. Subsequently a Manned CELSS prototype would be deployed. The development of a fully integrated bioregenerative life support system will be enabling of long duration missions such as a permanent Lunar base or Mars missions which need to be both secure and autonomous.

February 16th, 1993, Biosphere II's scientific panel dissolved. Earlier the project had suffered when early participation of the University of Arizona was terminated. The program has also suffered from bad publicity which has tended to raise questions about the integrity of the project and which has conveyed the impression that the project has 'tampered' with its results by breaking its seal and pumping in some outside air. Containment of the seal has also been questioned as nowhere near reaching the 1% goal initially set. Some press coverage has reported a significant percentage die off of the 3800 odd species of plants, animals, and insects placed into the enclosure.

It is difficult for this observer to determine from the popular press what other scientific and technical problems may have been encountered. In large part this difficulty is inherent in the nature of a proprietary project which is attempting to develop a "trade secret" technology base which can then be marketed to recover the estimated 150 million dollar investment put into Biosphere II thus far. Having toured the facility several times during its construction, I was struck by the limited nature of the technical information available about the project. This secrecy in and of itself is understandable from the standpoint of the development of a trade secret technology base and is indeed common for much proprietary research. This same secrecy, however, does not invite peer review or permit open reply to disgruntled ex-employees, who I understand, are in legal jeopardy as a result of agreements signed at the initiation of employment at Biosphere II.

It is clearly too soon to write off the Biosphere II project as a fraud or a scientifically invalid effort. Its goals largely parallel those articulated by NASA. However the NASA approach, present and future, involves a smaller scale sequential approach to the complexities inherent in CELSS development. NASA seems perhaps less grandiose in setting a narrow focus on food production and bioregeneration of wastes. NASA does not talk grandly about biome system development and maintenance, much less try to build the large scale test bed that Biosphere has constructed with a variety of biomes.

Biosphere II engineering is exotic and wonderful to see with the space frame structure set against the magnificent mountain background of Sunspace Ranch. It is questionable as to why anyone with the goal of a 1% leakage rate would resort to a glass pane system with thousands of feet of glass panes edges to seal against the daily expansion and contraction of the desert temperature extremes. Would not the use of a series of extensive metal tanks (perhaps on the order of the space shuttle external tank) interconnected in a manner feasible for lunar or Martian base construction been much less challenging in terms of gas seal? The energy cost of lighting such a complex may have been a financial reason for the green house strategy as opposed to the type of "ecology in a can" approach that seems inevitable for rocket-launched "biosphere" systems.

Neither the Lunar, or the Martian environment would permit anything like Biosphere II to be constructed given the extreme temperature ranges and the high radiation environments.

Martian and Lunar habitations will need to be buried under a minimum of two meters of regolith and perhaps twice as deep to survive solar flare storm radiation.

On the other hand it is not without merit to do trial and error research. This approach may in fact lead us more quickly to a better understanding of the critical variables at work and the design deficiencies of the current Biosphere II. In the long run it does seem important to look broadly at the biomes that man must take with him as opposed to "bread" and regeneration alone". Perhaps it is not bad science to try to design complex biomes, look carefully at the "failures" of various communities of plant and animals to sustain, and to work incrementally on increasing the survival rate of, increasing numbers of plant, animal, insect, and microbiology communities. With so many potential feedback loops to map mathematically between 3800 species it may be best to inform our mathematical models with the repeated trial runs of complex systems. Smaller, more tightly controlled variable research might never yield the same understanding of a few large scale systems "flops" at Biosphere II. Even if the system crashes down to a small percentage of the starting species it would be worthwhile to see if the "crash" was consistently repeated. Chaos theory might challenge the ability to reliably model the future functioning of so complex a system. The system itself might not "know" this and exhibit some surprising regularities in performance. Something novel might be learned by such experiments.

I am not therefore disheartened by criticism of former scientists disgruntled by legal "gag" contracts and under threat of lawsuits. Nor am I disheartened by initial problems with hardware performance, and operations performance different from initial expectations. Complex experiments encounter these human and technical problems all the time. Only time and repeated results will be convincing that anything useful has been learned from Biosphere II.

I am more troubled that Biosphere does not realistically model equipment, operational conditions, or the schedule of operation that are directly analogous to Lunar, Martian, or space station prototype models. Lunar and/or Martian soil simulants used as the basis for evolving soil beds might have been used to demonstrate the evolution of a mature productive soil with a diverse and effective microbiology community. They haven't been. The limited reports to date of significant species reduction might suggest that Biosphere II adapt as its theme song "Yes, We Have no Bananas". Reports of mite infestations of potato crops might mean a slight change of lyrics and a loss of "fries" potential for the first round crew.

Such failures may also be a reflection of poor technical execution of plant and species selection and horticultural technique. Perhaps a "C" team or a "D" team might do better than the first round of consultants. It may also be that the management and funding components of the program are compromising the professional efforts and operational judgement of the horticulturalists and botanists, dooming them to failure. For that judgment we may have to wait for the volume "Biosphere II the Biopsy" to be written.

Since no taxpayer dollars are involved in this project the public is not being defrauded no matter what happens. Mr. Bass and other investors in Space Biosphere Ventures Inc. might well worry that the poor analogy to lunar and/or Martian equipment and environmental conditions is a waste of their risk capital in developing a technology that can be sold to the spacefaring nations at a price that will recoup the initial investment and operating expenses of the project.

To a large measure, the Biosphere II Project has been a huge success in increasing public awareness of the significance of space horticulture and the science challenges facing the extension of humanity's operational realm to the Moon, Mars, and immediate Solar System. Its potential for public education is as great as its potential harvest of "hard" science, and as an engineering test bed for large scale CELSS.

Until much more details of this first experimental run are known, we can hope that the project will continue with a net gain in techniques applicable to space development and occupancy. These research issues remain a key missing piece of the technical capability to capture the economic potential of space-derived energy resources which must be handled if Biosphere I, Planet Earth, is to survive with its human population having an economy. The

stakes and uncertainty are high for Biosphere II but then the stakes and uncertainty are high for planet Earth as well.

DD

Materials cited or paraphrased are from the following:

1. **Biosphere II The Human Experiment**, By John Allen, 1991 Penguin Books New York, New York ISBN # 014 01. 5392-6.
2. **Lunar Base Agriculture: Soils for Plant Growth**, Editors D.W. Ming & D.L. Henninger, 1989, American Society of Agronomy Inc. Crop Science Society of America, Inc., Soil Science Society of America, Inc., Madison, Wisconsin.

Biosphere II: Brave New World or Disaster?

What Can Space Enthusiasts Learn From This Experiment?

By Michael Thomas, Seattle L5 Society

No one can deny that Biosphere II has been a public relations disaster; but is it a scientific disaster as well? Or is it the brave new world it was meant to be? With months to go before it's two year trial run is over, Biosphere II seems to have fallen short of it's lofty and ambitious goal of being a brave new world: a self contained and (except for electricity) a self sufficient biosphere.

There have been criticisms from the scientific community and the media about lack of scientific controls, too few scientists on the staff, lack of candidness, and cheating, that is, filtering out carbon dioxide, and more recently, injecting oxygen. And now the panel of scientists appointed to oversee it after previous criticisms have resigned.

This is not a good sign, but is it really a scientific disaster? I submit that the only way it could be a scientific disaster is if it provided no useful information. There are many lessons already learned from biosphere II, and much useful information. So while it may have fallen short of its lofty goals, it is by no means a disaster. What lessons have we learned already?

- **Lesson #1: You cannot recreate the whole world in a few acres.** But recreating seven of Earth's major environments in "biomes" was as much an aesthetic, even metaphysical goal, as it was a scientific one. It is rich with symbolism and emotion, but hardly an essential element of a self-contained biosphere.
- **Lesson #2: Including "biomes" of desert, savanna, and others low in plant density, do not make for efficient life support.** Most of Earth's oxygen production and Carbon Dioxide removal occurs in the oceans and dense forests, particularly rain forests. Cacti in the desert and grasses in the savanna do not provide a very large fraction of the oxygen we breathe. Therefore, deserts and savannas do not make efficient self-contained biospheres.
- **Lesson #3: Making a biosphere very large and complex does not necessarily make it efficient.** Biospheres should be designed for efficiency, not complexity, and certainly not aesthetics. We should do what works, not what is popular, nor what looks good.
- **Lesson #4: In order to support one human being, a bio-sphere needs a lot of space and a lot of plant matter.** Biosphere II in its present state, is not quite adequate for the number of persons it contains. It might, however, support fewer people adequately if not too much labor is required of the smaller crew. A crew of four might be good for a second run of the experiment.
- **Lesson #5: Biosphere experiments need to be designed to produce quantifiable data.** Here are some essential formulae that need to be determined. First, how many pounds of plant matter are required in a closed biosphere to supply the nutritional needs of one human being of average size? (This includes plant matter required for the nutritional needs of any animals that are to produce milk, egg and/or meat [if a non Vegan diet is to be supported.]) Second, how many square meters of "leaf surface area" are required in a closed biosphere to provide the oxygen needs of one human being of average size? [Plus the amount needed for animals if included.]

Where do we go from here?

In comparison with smaller previous experiments like those conducted by NASA and in the former Soviet Union, Biosphere II is unequivocally the largest and most successful biosphere experiment ever done. Despite the negative publicity, its failings compared with its successes, are relatively few and small. It has not been kept completely self contained, but has come a lot closer to that goal than any previous experiment with humans that ran longer than a couple of weeks

So what can we space enthusiasts learn from Biosphere II? One thing is that if a space habitat is to be a completely self-contained biosphere, with all biological recycling of elements and no artificial (mechanical/chemical) recycling of elements, it will have to be large and the human population density will be low. And low population density is not an acceptable condition for space habitats, as it would render them economically infeasible. So how do we solve this problem?

There are two approaches to solving this problem, which, in some combination, can be used to produce a habitat that will be economically feasible.

Artificial means of recycling elements can be used if they require no import of bulk materials from outside the habitat [or host environment, i.e. the surface of the Moon or Mars]

Humans and plants can be housed in separate structures in space: habitat quarters for humans, **habitats**, and habitable quarters for plants, **agritats**. There are many benefits to be gained from this strategy.

Humans have more rigorous health requirements than most plants. In space, people need artificial gravity, a dense atmosphere, and radiation shielding. While more research needs to be done, it is very likely that plants can make due with less of all these things. Artificial gravity, shielding and air pressure all require increased structural strength. And increasing the strength of a structure can only be achieved by increasing its mass, and by using stronger materials: titanium. This, in turn, increases the cost of the habitat exponentially.

If structure "A" has X amount of artificial gravity, X amount of air pressure, and X amount of radiation shielding, and structure "B" has 2X amount of gravity, air pressure, and radiation shielding, it will cost much more than 2X dollars to build, because of the geometric scaling of the structure massive enough to accommodate these changes. It all adds up. Therefore, such an expensive habitat should only contain things that cannot survive in a less costly habitat.

[**Editor's note:** The author, in all his considerations that involve gravity level, has in mind space settlements or oases in free space, not on the surface of the Moon or Mars, where the gravity level is a given. However, the air pressure values are relevant for planetary surface habitats also.]

Air Pressure Constraints for humans and plants

The minimum air pressure humans can breathe is 1/10th that at sea level, or about 100 millibars, Mb. And at this level, pure oxygen is required. The atmosphere in a large habitat for humans will probably be at least 500 Mb, or half Earth-normal. But many plants can thrive in a carbon dioxide atmosphere of only 50 Mb, or 1/10th that likely to exist in a human habitat. It is likely that almost all plants will grow in an atmosphere of nitrogen, oxygen, and carbon dioxide at a pressure of 100 Mb, 1/5th that likely in a human habitat.

This would not constitute a breathable atmosphere for humans, but the 100 Mb pressure would allow humans to breath pure oxygen from a tank and work without a pressure suit within the agritats.

Gravity Constraints for humans and plants

Similarly, humans will require a certain level of gravity to maintain normal health and be capable of returning to Earth. Since it is unavoidable that humans will be living in lunar gravity, 1/6th Earth-normal, human habitats [in space] are likely to be designed to a similar level [which would require 1/6th the radius required to provide that gravity level at a given rpm, and (1/6) cubed the amount of structural mass for any given shape structure, and a correspondingly

greater likelihood that such a structure will ever be built!] Yet it is likely that many plants will be able to survive at a much lower level of about 4.25% G or a quarter of the lunar level.

Shielding Constraints for humans and plants

Plants are sensitive to radiation, but still can tolerate a little more than humans [especially if the seed stock is more fully protected.] Gardeners working in the plant agritrat will need some [slideaway] shielding even for short periods of a few hours. Nevertheless, I believe that an agritrat could get by with about 1/3 the shielding needed for a human habitat. During high radiation episodes like solar flares, all humans could simply return to the safety of the more heavily shielded human habitat areas until the episode had passed.

Given the kilograms of plant to kilograms of human ratio required by a mostly biological CELLS system, it is very likely that an agritrat (the farming areas) will have to be measurably larger than the habitat (residential) areas, perhaps 2 or 3 times as large. Therefore limiting the mass of the agritrat [by lowering pressure and shielding levels, and in space habitats, by lowering gravity levels as well] will be more important than limiting the mass of the habitat areas. I believe that an agritrat with .0425 G (applicable in space only), 100 Mb atmosphere, and minimal shielding could be built much larger than the human habitat without using any more mass than is used in the human habitat. The agritrat areas, though comprising a majority of the volume, could account for less than half the total mass and cost of the space colony.

The most important factor in determining the efficiency of a CELLS, is that it be fully closed, not that its functions be fully biological rather than technological.

There is nothing wrong with technology, so long as you don't have to import anything from outside the [space] habitat [or the host planetary surface] to use it. Because the human habitat will be as small and compact as possible to save on cost, it is likely that it will not contain many plants, other than ornamental house plants or perhaps household mini-gardens in resident's quarters. Carbon dioxide and oxygen will have to be exchanged between the habitat and agritrat. And because they will exist at measurably different pressures, it cannot be accomplished by simple ventilation. That means that carbon dioxide will have to be removed from the habitat's atmosphere by machines, not plants. This will not affect the closed nature of the habitat-agritrat duo.

Nothing need be imported but electricity to drive the machines. The most straightforward way to remove the carbon dioxide is by freezing it out. And I recommend the use of acoustic refrigeration devices which require no working fluid, and, except for vibrating, have no moving parts. Air could be pumped through a cold chamber, where at a temperature of -250 °F, the carbon dioxide would condense into dry ice and be removed. The waste heat from the acoustic refrigerators could then be pumped through a heat exchanger to reheat the purified air. The dry ice could then be transferred to the agritrat, where it would be vaporized and used to supply the needs of the plants.

The carbon thus removed from the habitat would eventually be returned to the habitat in the form of food. The oxygen thus removed from the habitat would have to be returned artificially. The agritrat would also have an acoustically refrigerated chamber that would freeze out carbon dioxide. But in this case the frozen carbon dioxide would be reheated and vaporized with the waste heat from the acoustic refrigerators, and remain in the agritrat, while the oxygen rich purified air would be compressed to a pressure of 500+ Mb and pumped into the human habitat. This cryogenic separation of the air would make possible the necessary interchange of gasses between the agritrat and the habitat to meet the needs of both with a system that is both biological and technological, but nevertheless closed. Only the energy to drive the system would come from outside the habitat.

Biosphere II: Looking Back

Biosphere II, while it may have been plagued with many problems, is far from being a disaster. We have already learned much from it. And if a second run of the experiment is designed to be simpler and more efficient, while eliminating elements like desert biomes that contribute little to the success of the biosphere, we can learn even more. Something is a failure only if we learn nothing from it.

MT

Towards BIOSPHERE “Mark III”

A Practical step-by-step Game Plan For early Lunar and Space Settlements

By Peter Kokh

One can look at the unfolding experiment of the Biosphere II project in Arizona and say it should have been bigger or smaller, simpler or more complex, had a lower people to biomass ratio, etc. I submit the place to start is not in adjusting any of these parameters at all, but rather in altering the basic assumption. The assumption that off planet settlements should have a closed loop life support system still seems worthy of unqualified support on logistical-economic grounds. But, as Michael Thomas points out above, that this loop must be fully biologically maintained – without chemical or mechanical assist – is not demanded on economic grounds.

If a fully biospheric system is desirable, it is so for esthetic or philosophical reasons. Self-maintaining biospheres also merit support as a long term strategy, in that biological systems are capable of self-repair whereas mechanical and chemical ones are not – so far. Even here, with the advance of cybernetics, a worry-free “hands-off” chemical-mechanical component is at least not unthinkable, if still Science Fiction.

Our purpose is to establish communities in space that support the retrieval and use of off planet resources to alleviate the economic, environmental, and energy constraints plaguing the ailing Closed-Earth System in which human civilization has unfolded up to the present day. If we are to do this in a timely fashion, i.e. as soon as the other needed elements are in place for transportation, raw materials mining and processing and off-planet manufacturing capabilities, energy collection and delivery (perhaps including helium-3 burning fusion plants) and so on – then perhaps we should not be held ‘hostage’ to the demonstration of a fully successful biospheric system. The biosphere may prove the element most difficult to achieve.

Biosphere II has three principal areas: the habitat or “city”, the food-production area or “farm”, and the ‘wild’ and ‘natural’ multiple biome “biosphere” area proper. There was widespread recognition that the amount of biomass represented in a proportionately-sized farm area would not be enough to close the system. That assumption has been proven correct. I propose, however, that our response should not be to design even more elaborate setups with even more generous acreage devoted to forest, ocean, and other natural biomes.

Instead our goal should be clean and simple: self-sufficiency in food production except for luxury items and delicacies. We need to build a working modular food-producing farm system. Such a system will measurably “assist” in cleansing the air and water, but not do the job totally. At first we must be content with this “assist” and make up the deficit by mechanical and chemical means.

As the Lunar settlement grows, the proportion of the life-support loop that is closed “biospherically” is bound to grow. As we start adding less cramped residential quarters built from cheaper Made-on-Luna building materials, settler homesteads are likely to include a “garden space atrium with solar access” as a very popular option. Public thoroughfares and passageways are likely to be landscaped, a green answer to the sterile gray outlooks. But over and above these incremental additions to the total biomass of the settlement with the resulting increase in the biomass to people ratio, the farm unit acreage per person is itself likely to expand significantly.

This farm expansion will come not so that the settlers can eat better, but so they can help feed other pockets of humanity in space that are less equipped to grow their own food. Anything grown on the Moon will consist of 50% or more Lunar oxygen by dry weight, with 89% Lunar oxygen in all the associated water. This simple fact means that even if all the carbon and nitrogen and hydrogen incorporated in living tissue grown on the Moon must still be upported out of Earth’s deep gravity well, capital equipment costs amortized, the cost delivered to Low Earth Orbit space stations, factories, hotels, etc. – and to anywhere else in space – of Moon

grown food will be significantly lower than that of equivalent food grown on Earth and shipped up the gravity ladder.

Space settlements will surely have their own food production areas. Nonetheless, until these are well established, a lunar settlement may be producing far more food for export than for its own consumption. Not only will this food go to off Moon space markets, and to spaceships, it will also go to smaller, perhaps tentative outposts elsewhere on the Moon. All this extra biomass may come close to closing the loop.

Further, farm grown fibers may be the cheapest and only acceptable way to clothe space frontier folk. The farms will be called on to produce a lot more than just food. That too will boost the biomass-per-inhabitant ratio.

As settlements grow large enough, and earn enough from exports, they will surely want to establish "Nature Parks" whose flora and fauna citizenry are chosen to add delight, enjoyment, education, and relief. By the time the first settlement is large enough to do so, we might be better prepared to select self-maintaining stable ecosystems, collections of plants and animals that will live in fairly stable harmony with one another – at least better prepared than we are today! Only then ought we to contemplate closing the loop by biospheric means alone, phasing out chemical and mechanical systems from general service, but keeping them on standby for fallback duty in case of major crop failure or ecosystem collapse.

Towards the Biosphere in 4 Step by Step Phases

I: Farms for Food Staple Production Self-Sufficiency, sized for local settlement consumption.

II: Farm Expansion to serve Food Export Markets elsewhere on the Moon and in Space.

III: Farm Expansion to supply fiber and other nonfood but fully biodegradable and/or recyclable uses.

IV: Beyond private and common "gardens" to communal "Natural Parks", and their expansion as settlement discretionary trade surplus income allows.

We have all been captivated by the Biospheric Siren. We are coddled from birth to grave by Mother Earth. It is understandable that it should be our Goal, big G, to establish totally separate, fully self-sufficient, mini-biospheres beyond Earth's atmospheric shore within which to reencradle our lives. But for perhaps many generations to come, this ideal will be but a standard by which to measure our progress, not something we have to achieve before we dare to cast off. PK

MMM # 65 May 1993



Using Hitchhiker and Bonus Imports to Hasten Settlement Self-Sufficiency

STOWAWAY IMPORTS By Peter Kokh

Three Opportunities for strategic substitutions

There are three basic categories of opportunity to ship to the Moon badly needed "Lunar deficient elements" – strategic metals and volatile feedstocks – virtually for free. That is, the

freight is actually being billed to other import items, and would still be levied whether these opportunities are seized or not.

These are

- (1) **containers and packaging materials or “tare stuffs”** used to ship the principal items on the Manifest;
- (2) **parts and components of imported items** that would normally be made of elements in which the Moon is already well endowed [see the end of the “MUS/cle” article just above]; and
- (3) **cannibalizable parts of the shipping vehicle or of its outfitting** that either are not needed for the return trip to Earth and could be replaced there, or which could be replaced with Lunar substitutes upon arrival on the Moon.

In all three cases, play in the “substitution game” is initiated on Earth. In the second and third case, there is a “counter” or “complementary” substitution made on the Moon. In the second case, this match move could be delayed for some time, the endowment being “banked” in the imported item as it is being used [see the previous article].

What substitutes for what?

On the one hand, the stuffs, parts, and components in question are those that would normally be made of elements for which the settlement has no need, namely, those which can be produced economically on location: oxygen, silicon, iron, aluminum, and titanium especially. The operative rally cry here is “No Coals to Newcastle” i.e. no ice for the Eskimos, no sand for the Saudis, etc. Shipping or co-shipping items so formulated constitutes no less than a criminally wasted opportunity to bootstrap industrial diversification.

Instead, we want to substitute other metals such as copper, zinc, lead, gold, silver, platinum, etc., or alloys rich in them such as duralumin, monel, bronze, brass, pewter, etc. Where such substitution is impractical, an alternate option is to preferentially use stainless steel or any of several other industrially desirable steel or aluminum alloys for which the alloying ingredients cannot be easily produced on the Moon.

Some constraints apply: the substitute metals must be formulated to perform adequately, and must not involve added weight. The trick is to avoid paying a weight penalty in substituting heavier metals for lighter ones by using less of them or by other tricks. If this pitfall is avoided, substitution costs aside, the actual transportation costs will be nil, charged as “overhead” on the bill for the principal shipment, whether the helpful endowing substitution is made or not.

As to oxygen, it is a principal component – often in the 50% range – of paper, cardboard, wood, plastics, styrofoam, and other materials often used as containers, packaging wrap, separators, and fill. Instead, it will be to the settlement’s great advantage to substitute tare stuffs formulated from low polymer hydrocarbons that can easily be broken down into the constituent hydrogen and carbon – both very precious on the Moon – or used as chemical feedstocks in Lunar industries.

Other substitution possibilities include soaps and waxes and friable or biodegradable compositions rich in those agricultural micro-nutrients or fertilizers in which lunar regolith soils are impoverished. A stuffing and cavity-filler option that could sometimes be appropriate would be to use air- or freeze-dried luxury food items (to be reconstituted with water made with lunar oxygen) (e.g. fruit, milk, eggs, spices) not likely to be produced in the early stages of lunar agriculture and which would add much to special occasion menus and to overall morale and morale-dependent productivity. Such items (along with human wastes from arriving ships) will be much valued accumulating additions to the local biosphere.

Oxygen is also an unnecessary 21% of the Earth air with which cargo holds would normally be pressurized. Instead we could use pure Nitrogen, the extra 21% most appreciated on the Moon. For the return trip, the holds could be pressurized with Lunar Oxygen, either alone or buffered with Argon and Neon scavenged from the regolith by modest heating.

As every gram of pest potentially takes the place of many pounds or tons of food or product in the food chain, pressurizing holds filled with seeds and seedlings with pure Nitrogen, heated to 65° C (150° F) or so could be doubly important. Attention to a whole host of “little” opportunities like this could make the difference to settler self-sufficiency. Lost nickels and dimes add up quickly to real lost dollars.

“Changing the Rules:” Cannibalizing Outbound Vehicle Equipment

Passenger and Cargo ships alike bound for the Moon will contain many components, parts, and items of outfitting that are either not strictly needed for the trip home, or which could be replaced by Made-on-Luna fabrications for the trip back to Earth. If these ships are deliberately designed and outfitted for cannibalization, the cost of off-the-shelf assembly-line-item reoutfitting per flight could actually be less than the customary one-time individually customized outfitting that has become NASA’s one-trick pony.

Certainly this will involve a major paradigm shift for those spacecraft designers and their cheering sections who currently are aware of only two sacred cow choices: Expendable and Reusable – neither of which are anywhere near appropriate for opening the frontier. These two are like Thesis and Antithesis. The Synthesis is to send ship[parts] one way to the frontier for “Reassignment” there. So add Reassignable to Expendable and Reusable. It’s a frontier door-buster.

Until industries are in place to fabricate replacement parts, only those items not actually needed for the trip home can be removed upon Moonfall for cannibalization. Gradually, other parts can be replaced on the spot with prepared Lunar fabrications. We’d be removing items made of Lunar deficient metals and alloys and volatiles and replacing them with items made of Lunar abundant materials (iron, aluminum, glass, glax, ceramics etc.) from basic settler industries.

What type items are we talking about? Nonstructural (akin to non-load-bearing) interior partitions; floor, ceiling, and wall panels; interior doors and trim; fuel tanks, eventually even cargo holds, platforms, exterior booms and beams etc.

For ships carrying settler recruits one way and returning empty except for crew, the list includes the partitions and decor panels of individual quarters, dishes, cutlery, and food preparation equipment, cabin furniture and furnishings, entertainment equipment and libraries, beds or berths, bedding and towels, sinks and toilets, even snap-in/snap-out copper wiring harnesses. If you use your imagination, the list gets surprisingly long and potentially all-inclusive.

Indeed, we’d have the choice of either stripping the passenger cabin or removing it wholesale to be mated to a new chassis and used as a surface coach! Or perhaps covered with regolith and used as a construction shack in the field! Even here, we’d want to have as much as possible of the cabin and its original outfitting made of Lunar deficient materials for gradual retrofitting replacement with local fabrications allowing the original materials eventually to be cannibalized.

Best of all, the fuel expended in getting all this accessory equipment to the Moon gets billed as part of the passenger fare or cargo freight whether any of this stuff is removed or not. So IF we designed the craft and its outfitting for this kind of wholesale reoutfitting each trip, using “knock-down” assembly techniques to make the job a breeze, the settlement can get all this “loot” virtually for free.

If you think about it, the whole concept of Reassign-ability absolutely shatters up till now universally accepted fuel to payload ratios. Potentially, everything except fuel becomes payload. And that changes the economics of opening the space frontier quite independently of whether or how soon or how much we realize cheaper access to Earth orbit.

Earthside Entrepreneurial Opportunities

Formulating and fabricating items out of elements scarce on the Moon instead of those abundant there may or may not lead to terrestrial applications. That depends largely upon entrepreneurial imagination and market testing. Making tare items (containers and packaging etc.) of alternate materials should certainly lead to marketable products for consumers who are

becoming increasingly sensitive to the environmental impact of everything they use. The idea of making things to be reassigned and/or cannibalized is sure to have applications both in the consumer products field and in the continued opening of terrestrial frontiers like Antarctica. Imagination is the only limit.

The Bottom Line

To a lunar settlement, every pound or kilogram of imports or co-imports “along for the ride” made of elements economically producible on site “costs” a pound or kilogram of dearly needed “lunar deficient”, hard-to-do-without elements not locally producible, that could have been imported instead for the same import bucks. This is the kind of opportunity that a for-profit operation seeking to open the frontier would eagerly seize upon. It is also the kind of opportunity that deficit-jaded government operations routinely shrug off.

Taking the pains to reformulate these potentially free “stowaway” imports will slowly but inexorably build up substantial endowments on the settlement site that will go a long way towards removing the severe industrial handicaps under which the pioneers must otherwise operate – and all virtually free of real added cost. The fuel expended to get these items there, reformulated or not, is in effect a hidden import tax. As this tax must be paid anyway, it'd be unforgivable not to use the bootstrap opportunities involved. <MMM>

MMM # 66 June 1993

Letting the Right Hand Know



What the Left Hand is [by]doing

“A question of not wasting spent personpower”

ENCYCLOBIN: LETTING THE RIGH HAND KNOW WHAT THE LEFT HAND IS [BY]DOING

By Peter Kokh

Making the most of energy and personnel will be very important anywhere on the space frontier where existence must be eked out in barren surroundings untransformed by eons of living predecessors. Support from Earth will be dear, no matter to what cost/per kilogram launch expenses fall. To waste no import crumb, to put to best use every scheduled productive hour, to get the most out of the talents of available personnel, it will be vitally important to keep track of things of which we are by habit oblivious in our terrestrial “business as usual”. The settlement with the cavalier attitude towards loose ends will fail. The one that ties up those loose ends in bonus bouquets will thrive.

What is needed is a hyper-organized or multi-dimensional matrix type data base in which the settlement can keep track of every gram of reject and byproduct and waste in every category of material from all its industries and enterprises. Any enterprise would be able to access this resource bank and find out which of its needs is available, where, and for how much. Any discarded material has already had work done on it – if only the sorting, and putting that expended work to profitable use, instead of losing it in a default waste regime, will enhance by that much the net productivity of the community.

Relatively unprocessed tailings, partially processed slag, fully processed reject material; solids, liquids, gasses, even waste heat: these are all things worth keeping track of if one wants a leg up on the formidable odds against success of the settlement. Such items can then be banked where produced or moved along specific routing channels to some surplus commodities exchange warehouse. Purchases can be direct two party affairs or mediated by the utility as a special broker.

Using “partially cycled” or “precycled” items makes as much economic sense as using “recycled” ones. It keeps down the cost of manufacturing new goods, can be the source of new enterprises, and helps minimize the material impact upon, and disturbance of, the host terrain, thereby stretching resources that future generations will need as well.

An “Encyclobin” Utility would be a publicly regulated enterprise to keep track of all such items and charged with facilitating their fuller use as potential resources. By keeping track of byproducts unwanted by each producer, it will help inform the “right hand” of what the “left hand” is “bydoing” so to speak. Personal talents, expertise, and experience ought also to be listed for help in putting together teams for new projects. Encyclobin would serve as a finder service, for which there would be a fee to help maintain and grow the system. The **University** might run such a system to best categorize everything, trace potential connections, and suggest novel applications to enterprise. Waste not, want not! **MMM**

MMM # 67 July 1993

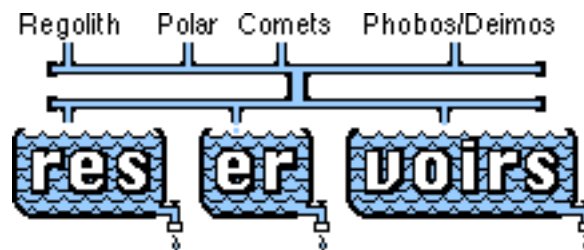

Making the most of Water in Reserve

By Peter Kokh

Certainly for smooth running and timely growth of lunar settlement and industrialization we will need substantial water reserves in excess of those actually in domestic, agricultural, commercial, and industrial cycle use. In addition to the recreational uses of water in deodorized stages of treatment suggested in the article that follows, additional fresh reserves can be used for recreational and landscaping use. The in sight availability of such reserves will be reassuring to the settlers, and obvious drawdowns a cause for political concern and action. Such extra open water reserves could support wildlife and additional luxury vegetation. Another use of fresh open water storage is as a heat sink to control the climate of the settlement biosphere.

Inactive storage of water-ice made from hydrogen co-harvested in Helium-3 mining operations or brought in by Hydro-Luna from various off-Moon sources can be cheaply provided in lava tubes. The first waters would quickly freeze and self-seal the tube from leakage. When needed, ice could be cut and hauled by truck or conveyors to pressurized areas for thawing and use.

Handy lavatube storage will be available in many mare areas and will be a consideration in choosing settlement sites. Where settlements or outposts are desirable in areas devoid of such underground voids, there are other options: Hydrogen gas can be stored above ground in pressurized tanks, but to prevent leakage and other problems, a better way to store it would be as methane or ammonia, either liquefied or as pressurized gasses. Conveniently, it is in such form that out-sourced volatiles will be imported in the first place. Further, storage in this form is very versatile allowing volatiles to be drawn down, resupplied, or shipped elsewhere all by automated pipeline systems. As a bonus, at the use market destination, they can be run through fuel cells or steam turbine boilers to generate electricity as well as water and other volatile products.

Both methane and ammonia have major agricultural and industrial uses. In both cases, introducing added water into these cycling systems through this form makes elegant sense.

How much of a Water Cushion should the settlement strive to maintain? New water must be added not only to support growth in population, agriculture, and industry but to make up for inevitable losses. While major attention must be paid to preventive strategies to minimize losses of water in the various loops, accidental and other difficult to prevent losses will still occur. These need to be made up and the rate at which such make-up additions are needed will greatly affect the local “cost of living” and indirectly, the “standard of living.”

It would be wise to have a 2 year reserve sized not only for make-up use but also for planned growth. With quick additions difficult, planning and foresight are needed. **MMM**

The Settlement Water Company



Care and Treatment of a Finite Resource

By Peter Kokh

Industrial Exclusions: “Closed Loop” water systems for some industries

While even on Earth, abundant water for industrial use is not something everywhere to be had, in general, water supply is simply a matter of location. And given a wise choice of location, both the supply is cheap and the discharge is easy.

Water is used to move raw materials – in slurries. It is used alone or with detergents as a cleaning medium. It helps separate particles by size – powders floating to the surface, heavier particles precipitating to the bed. Doped with emulsifiers it helps separate suspended materials normally impossible to separate.

Water itself serves as a chemical reagent. But more frequently it is used as a delivery medium for other more reactive dissolved chemical reagents.

A fine-tuned jet of water under pressure can be used as a cutting and shaping tool. Pressurized abrasive suspensions can wear away stubborn surface deposits.

Water is used in enormous amounts to cool by carrying off surplus waste heat. Combined with a heat source, it becomes a source of considerable power – steam! – the genie that unleashed the industrial revolution!

Its hard to see how we can even talk about industrial operations on the Moon if water is a scarce item! Clearly, in a situation where the water source is not constantly and automatically replenished, an abundant naturally cycled freebie, it becomes instead a very finite capital endowment that can only be replaced at great cost. Even if replacement charges can be lowered to mere thousands of dollars a ton or cubic meter, water will be “fanatically” recycled.

Nor would it make sense to funnel point source industrial discharges laden with particulates and chemicals into the general residential-commercial water system of the host settlement community. It will be far more efficient for each industrial operation to recycle its own discharge water – water that is still dirty in a known and limited way – before it gets mixed with differently polluted discharges from rather diverse industrial operations elsewhere.

Industrial operations then ought to have closed loop water systems. Not only does this make the job of water treatment much easier and simpler, it provides strong incentives for more conservative use of water contaminants in the first place. Plant engineers responsible for the water cycle will want to keep their job as simple as possible. Chemical agents used in industrial processes will be chosen not only for how well they work, but for how easily and totally they are recovered.

Where water is used for cooling, there will be strong incentives to cluster facilities that discharge heated water with operations that could put such a heat source to good use. A “thermal cascade” then becomes a natural way to ‘organize’ an industrial park – ‘organically.’

An alternative is simply to store heated water for nightspan use to even out indoor and midroom (pressurized commons) temperatures throughout the sunth (lunar dayspan–nightspan cycle 28.53 standard 24 hr days long).

Double Duty Storage of Water Reserves and of Water-in-Treatment

The water utility – both that of the Settlement at large and those in-house systems used in lunar industry – will have three types of water “pools”: **a)** clean, ready-for-use reserves, **b)** waste water awaiting treatment, and **c)** water in process of treatment (settlement pools or cooling ponds, for example). For the first two categories, there are both essential and luxury morale-boosting uses of water that are quite compatible.

Stored water can be put to good use in maintaining comfortable temperature and humidity conditions within the settlement. By freezing and or boiling some of the supply at appropriate times in the dayspan–nightspan cycle, the water reserves can act as a heat pump, be part of a heat-dump radiator system, etc. For water in treatment, distillation during boiling can work triple duty both to clean the water, regulate thermal levels, and produce power via steam.

Recreational use of stored water is not something to be overlooked. Even water in later “deodorized” stages of treatment may be clean enough for fountains, gold fish ponds and trout streams, and for boating lagoons and canals (“no swimming, please”). Nothing does more to boost the general ambiance and feeling of being in a “paradise” than generous, seemingly profligate, but totally self-conserving use of water. Judicious use of water reserves will be a primary function of the settlement water utility.

Making Treatment Easier – Smart Drainage Systems

As was pointed out above in the discussion of closed water loop recycling systems for individual industrial operations, it makes sense to keep separate, waste waters that are still diversely and relatively simply dirtied. Why mix waste water from a can-making company with that from a canning operation? More, why mix either with agricultural runoff? Or agricultural and garden and landscaped area runoff with human waste drains, or any of the above with bath and shower water?

In a previous article, “CLOACAL vs. TRITREME PLUMBING”, MMM #40, NOV ‘90 p. 4. [reprinted pages 36–7, above], we discussed a revolution in drainage philosophy, the first great leap forward beyond the Cloacal (one hole) system invented in Mohenjo Daro (200 mi. NNE of modern Karachi, Pakistan) about 4,000 to 4,500 years ago. Simply put – separate color-coded or otherwise differentiable drainage lines for diversely dirtied waste waters so that they can be separately and more simply treated and recycled. Here on Earth, where in every established community drain lines and pipes make up a major component of entrenched (both senses!) infrastructure, it would be prohibitive to replace them with a more sensible network.

But on the Moon, where we are starting from scratch, the additional upfront costs of “doing drainage right,” will pay off immediately in lower upfront costs of treatment systems, as well as continually thereafter in lower operating costs for the whole communal water system.

Double hulling, drip pans, leak sensors

When it comes to the Earth’s waters, Nature clearly pays no heed to the Proverb: “a place for everything, and everything in its place!” Even if the settlement shares a common megastructure atmospheric containment hull, it will be sound practice to keep water drainage systems and basins leak free, or at least leak-monitored and controlled. The separate drain lines might still be clustered over a common drip gully or gutter. As with modern gasoline (petrol) underground tanks, double hulling would be a wise policy. What is flowing or pooling around loose, even if technically still within the biosphere, is neither being effectively used nor recycled in timely fashion.

Humidity Control

Humidity could be a problem, especially given the high concentration of green vegetation needed to maximize the biological contribution to the clean air & clean water cycles. Plants transpire lots of moisture into the air.

While writers dream of biospheres in which “it rains” from time to time, for it to rain naturally may require an insufferable prior buildup of humidity, with all the damage that can do (mold etc.) in addition to simple discomfort. Instead, giant muffled dehumidifiers will be needed, and the nectar they wrest from the air will be the start of the clean drinkable water cycle. Yes rain cleanses the air of dust and other contaminants, but so can the artificial rain of controlled periodic misting, the abundant use of fountains and waterfalls, etc.

Rules — Protocols — Restrictions

Even water-dependent cottage industries, households, and individuals will have to accept some responsibility for wise use of the “liquid commons,” if they are to continue to enjoy its freshness, cleanness, and adequate abundance. Students may well be taught good cleaning, bathing, cooking, and gardening water use in unisex home economics courses.

Graduating youth may enter a Universal Service and spend some time manning all the infrastructure utilities upon which lunar survival is closely dependent, including the water treatment facilities. This too will foster thoughtful citizenship.

Water use might well be metered by progressive rates: rather reasonable prices for reasonable amounts; unreasonable prices for unreasonable amounts. Some home enterprises may need to seek Utility help in setting up closed loop water purification systems of their own: fabric dyers, for instance.

Mail Order Catalogs of items available to Earth may have pricing tariffs favorable to the import of items high in H, C, N, for example, and unfavorable to the import of items for which lunar-sourceable substitutes are currently “on line”.

Agriculture and Horticulture: Drip-Geoponics versus Hydroponics

In agriculture and home gardening alike, the naturally buffered, lunar regolith-using geoponics systems using drip irrigation should be more economical than hydroponic systems that import all nutrients from Earth, not just some of them. Water use in such systems can be controlled well enough, and indeed natural soil farming may be an “organic” part of the water treatment cycle. Here, as elsewhere on the Moon, water can't be used casually anymore.

MMM

Xer~~H₂O~~pr~~H₂O~~cess

xe ro- (ZEE ro): from Greek ξερος, “dry”

**Those planning industrial operations on the Moon
might well take a page from Xerox.**

XEROPROCESS By Peter Kokh

To go a step beyond the water conservation and treatment strategy of closed industrial water loops, the settlement authority can offer processing and manufacturing enterprises various incentives to design and engineer water “out of the process” in whatever use category this is practical.

For producers of metals and other basic materials to be used in lunar manufacturing, it is especially important to attempt to redesign tested and familiar methods, sometimes scuttling them altogether, to find regolith handling and sortation and beneficiation systems that use as little water as possible. For example, piped or trough-borne slurries can be replaced with simple conveyor systems. In pressurized quarters, air assists can be added, especially for separation of materials by particle size, powders from heavier grains. Vibration sifting can be factored in, especially in the unpressurized “outvac”.

The alternative is to provide relatively voluminous capital water endowments to such processors, along with all the water treatment equipment to create a closed loop. Xero-processing methods could result in a significantly reduced tonnage of capital equipment and endowment to be brought to the Moon. This translates to an earlier startup for the industry in question. If it is a keystone industry, that would be vital.

Water-based chemical treatments will be more difficult to do without and in that case the used doped waters must be recovered and recycled. Yet it is certainly worth brainstorming waterless methods, one industry-specific application at a time.

It is unlikely there will soon be anything that mimics our petroleum-based synthetic chemicals industry with its myriads of sophisticated derivative products rich in the exotic volatiles the Moon lacks in carefree abundance. Such products where it proves impractical to do without them, are better imported ready to use, leaving the associated industries, their capital equipment and discharge and waste problems alike, back on Earth where they can be better handled. Thus the use of water based emulsifiers and other organic agents in early lunar industries is unlikely in the first place.

For cleaning, sonic methods may do in some uses. In others, such as degreasing, water-based methods in closed loop systems may be the only practical option – unless alternatives can be found for the occasional use of lubricants and grease in the first place – here is the place to start in ‘option-storming’.

In using fine-tuned jets of water under pressure as a cutting and shaping tool, typically relatively small amounts of water are used and simply recycled. This judgment may also apply to some uses of pressurized abrasive suspensions in surface cleaning and treatment. Still, it is certainly worth exploring xero-process methods in both cases.

For cooling, little treatment if any is needed of the used water and it can be immediately recycled. Yet other methods are certainly preferable especially if the amounts and types of heat production allow. Options include heat pipes (possibly incorporating eutectic NaK, a Sodium-Potassium alloy that is liquid at room temperature) combined with surface radiators. If the heat could be useful for application in another part of the process, or in a “next door” companion industry, this needs to be considered in a decision whether or not to use water-assisted heat transport and whether or not to tie that into a power cogeneration scheme using steam.

If the industry’s processes are segregated into energy intensive and heat producing operations that can all be done in dayspan, and labor-intensive and heat absorbing operations that can be postponed and reserved for nightspan, then heat-pumping thermal output into and out of a water-ice reservoir makes sense. But as soon as a NaK production facility is on line and can meet the demand, substitution of this lunar-sourced eutectic alloy for water as a heat bank would save enormously on capital costs, translating to earlier startups and faster diversification.

Since it does come down to significant differences in required initial import tonnage and consequent time-is-of-the-essence diversification timetables and decisions, the choice may not be left up to industry. Where the settlement’s industrial and enterprise Review Board deems it practical, xero-processing and xero-manufacturing methods may be mandated, especially if already pre-developed. Whether a potential joint venture partner uses xero-industrial methods will then also make a difference in submission of a winning bid.

And what about agriculture and food processing? In the absence of regular-enough rainfall, plants and crops must be irrigated, and salts leached from the soil must be carried off along with waste fertilizers and pesticides. At food processing facilities, produce has to be washed, cooked or blanched, and often water-packed. Each specific step and operation has to be analyzed to see if it can be redesigned for either waterless methods or at the minimum for water use methods that cut down on the total capital volume of water needed as well as make the treatment and reuse of that water easier.

Nor can we wait for any of this until we are on the Moon and it is time to add a new startup industry. If we are not prepared to hit the ground running with enterprises thoroughly redesigned for lunar-appropriate methods, then valuable time will be lost one way or the other. Either we choose to pay the piper by bringing up a greater and costlier mass of capital

equipment and capital water endowment for inappropriate operations, forcing a delay in ability to import additional industries, or we tread water waiting for an industrial operation to be redesigned then – something that could have been done already.

So how do we see too it that when we need them, industries and enterprises using lunar-appropriate methods such as xero-processing are thoroughly thought out, engineered, field tested and debugged – already to go? One way is to set up an **Institute of Lunar Industrial Design**, NOW! This could be part of a **University of Luna – Earthside**, also set up now, not on the undergraduate teaching level, but on the graduate industry-subscribed research and development level. We propose to see to it that this is done, ready for its debut at ISDC 1998. **MMM**

Always listen to experts.

They'll tell you what can't be done and why.

Then do it.

– Robert A. Heinlein

MMM # 68 September 1993



By Peter Kokh

Settlers can't live by bread alone! Farm "Pods" can churn out many other needed products

Relevant READINGS FROM Backissues of MMM

[included in MMM Classics #1] MMM #4 APR 87 p9 "Paper Chase", Peter Kokh

[included in MMM Classics #2] MMM #13 MAR 88 p8 "Apparel," Peter Kokh

MMM #15 MAY 88 p5 "Threads," Aleta Jackson

[included in MMM Classics #4] MMM #40 NOV 90 p6 "METHANE", Peter Kokh

[included in MMM Classics #5] MMM #48 SEP '91 p8 "Naturally Colored Cotton", P. Kokh

[included in MMM Classics #6] MMM #55 MAY 92 p9 "Agri-Garments", Michael Thomas

INTRODUCTION

To date, Experimental Lunar Agriculture has concentrated on the production of fresh vegetables needing little or no processing (lettuce and salad stuffs) and on such staples as the potato (Ted Tibbits at the University of Wisconsin Biotron) and wheat and soybeans (Bill Easterwood at EPCOT Center).

But this is just a start. Not only will Lunar farm pods eventually produce far more food crops than those experimented upon to date, but it will be called upon to grow crops for quite other purposes. Fiber for clothing, toweling, and furnishings will be especially important. Household preparations, cosmetics, pharmaceuticals, and chemical feedstocks will take their place as well in the agricultural sector of the settlement economy. Anything organic that consists in major fraction of lunar-sourceable oxygen is potentially cheaper to grow on site rather than import from Earth. Different frontier communities will have their specialties, and trade between them should be brisk.

As an industrial activity, lunar agriculture will start as "small potatoes" yielding "produce" only that has to be "home made" into meals. Farm pods will be highly automated,

saving labor for mining, materials processing and manufacturing of building materials and energy stuffs for export as well as for use on the frontier to defray imports.

Food processing, which in America employs far more people than does food growing, will be insignificant at first, starting up essentially as part-time after hours cottage industry. As the number of people on the frontier grows, economies of scale in other areas of industrial activity will gradually make it possible to justify a growing primary employment in the food industry. Condiments, sauces, gravies, preserves, baked goods, precooked packaged meals, will no longer be flea market items but take their place beside “produce” in “grocery” stores.

The demand will be augmented by the growth in the number of small outposts of humanity – on the Moon, in space, in space ships, among the asteroids etc. Small incipient outposts would be stuck in the “salad bar” mode indefinitely if it were not for trade with larger more agriculturally diversified settlements on the Moon, out in L5, or elsewhere.

Agriculture will slowly emerge as a major sector of the industrializing lunar economy. To turn an old phrase on its head, pioneers can not eat, nor clothe themselves, by metal, glass, and ceramic alone!

Cotton Plant Byproducts

In a response to a question about the possibility of growing cotton to meet clothing needs, Dr. Tibbits gave the sort of horse-blinded response typical of a specialist unaware of the universe at large. “That would mean withdrawals from the lunar biosphere, making it inefficient. We can’t do that!”

To the contrary, if a non-luxury settlement need can be met with an agricultural product that is 50% lunar oxygen by weight, and the only remaining viable option is to import something with 0% lunar content, then net efficiency of the farming unit be damned. It is the gross efficiency of the Settlement with all its systems that is the bottom line.

The “synthesis position” here is that any and all farm products withdrawn from the settlement’s biosphere must be processed, treated, and fabricated solely in ways that allow the item, material, or preparation to be eventually recycled and/or returned to the biosphere by composting. This holds of fibers, fabrics, and dyestuffs as well as of cosmetics and household preparations. We need to keep our eyes on this larger picture.

From the point of view of the plant species chosen for cultivation, in the interests of efficiency we ought to be looking for suitable ways to use the parts of the plant not normally eaten, as well as ways to derive food and other products from the composting remnant waste biomass. “Waste not, want not” must be the watchword of Lunar Agri-Business.

It seems quaintly out of touch, however, given all the ongoing progress in plant breeding, genetic manipulation, and biomass treatment, to reject a suggested crop on the grounds that too large a portion of the individual plant does not serve the primary purpose for growing it. What is to prevent the recombinant DNA researcher from putting into future cotton plants genetic instructions that make the rest of the plant a) edible; b) a source of pharmaceutical or other desirable compounds? The cotton plant – its not just for Haines anymore!

Recombinant DNA opportunities aside, three more conservative measures suggest themselves. First it is possible to develop varieties to maximize yield and minimize “waste”. Second, we ought to be looking at the waste of the unaltered plant as potential feed stock for useful by-products.

Third, biomass waste for which no useful purpose has been found does not have to go on the compost heap to produce “nothing but methane and mushrooms”, useful as both may be. In Wisconsin, Biotronics Technologies (W226 N555B Eastmound Dr., Waukesha WI 53186) has developed – for NASA – “biodigesters” which turn “waste” biomass into an edible tofu-like product that can be used as a food supplement or staple. These devices are demonstrating an efficiency of 98% — that is, there is a stubborn inedible residue amounting to no more than 2%

the original biomass weight. We can dismiss the dismissers of cotton, then. Yet more research is needed.

The primary reason for raising cotton in space frontier farms remains fiber for clothing, bedding, toweling, cushions etc. Cotton is still the most comfortable fabric known to man, and happily the one with the largest oxygen content, making it the least expensive of all fabric options for any settlement or outpost dependent mainly on lunar resources. (Those who wish to try Jockey shorts made of fiberglass are welcome to do so.)

However, we currently subject cotton to a lot of treatments that would be inappropriate in a closed lunar biosphere. Mercerizing, which treats cotton yarns or fabrics under tension with caustic alkali in order to increase strength, luster, and affinity for dyes is an “unkosher” no-no — mixing organic and inorganic materials renders the latter unfit for recycling (i.e. the precious hydrogen and carbon content). Use of inorganic dyestuffs is out for the same reason.

Happily, breeding of new cotton varieties in which the fiber is “naturally colored” has already reached the market. Yellow-tan, rich brown, and green naturally-colored clothing, sheets, and knits bearing the Foxfiber brand are now available – with blues, yellows, and lavenders under development. This obviates the dyeing process altogether, along with the stress even vegetable dyes put on tightly recycling water systems.

All this means that the Cotton Goods Industry on the space frontier will look quite different from the one we are used to, even considering only the traditional fiber products. That industry will meet several important settler needs. Further it should provide a source of export income marketed to all pockets of humanity from low Earth orbit on up. For once the start up costs are amortized, Made-on-Moon cotton goods should be cheaper to deliver anywhere in space than those manufactured on Earth’s nearby but gravid surface.

But if cotton can be used to produce not only fiber and oil (cottonseed) but now also food (tofu) and maybe other products, it will join the prestigious company of other already well established “cornucopia” crops. As it happens, many of these versatile plants are also well known in the southern United States. We discuss some of them below.



Sweet Potato Byproducts:



Peanut Plant Byproducts:



Soybean Products:

The George Washington Carver Story

George Washington Carver 1864–1943, pioneer black botanist and chemist working at Alabama’s Tuskegee Institute, motivated by a desire to improve the economic conditions of southern farmers, gardeners, and orchard growers, and driven by the conviction that “every waste product is an undeveloped natural resource”, developed and patented over 300 useful by-products of the sweet potato, and a hundred-some byproducts of the peanut. He also worked with the soy bean, velvet bean, and pecan. His research career spans the period ‘97–’37; his most creative work taking place in the 1910s and 20s.

Food byproducts included flours and meals, six breakfast foods, candies, donuts and breads, flavorings for ice-cream, a milk and derived ice cream and buttermilk, a worcestershire-type sauce, a soy-like sauce, a coffee-like drink “superior to Postum™”, curd cheeses similar to Neufchatel and Edam, soft cheeses, a peanut milk from peanut flakes and water, a relish, punches and fruit juices, vegetarian steaks and meats, and more!

Other products included such diverse preparations as inks and facial pomade creams and perfumes, soaps and glues. He even patented a fabric, Ardil™, about which I was able to learn nothing at all.

Whatever food processing system he was using at the time yielded a residue, of course, and he looked at that residue (similar to mining tailings etc.) as a challenge and opportunity, as

something pregnant with new possibilities. He experimented endlessly and prolifically with an open mind.

How many of his inventive concoctions and preparations are being marketed today? I don't know. Assuredly many of them must have been of inferior quality, from a consumer point of view, to alternatives on the market from other sources.

For us the question is a rather different one. On the early space frontier – a brave new world laden with “rough edges” – when importing ready-to-use food luxuries, cosmetics and household preparations will be pricey if not prohibitive, could some of Carver's patents be used to create a homegrown supply of some of these items on the Moon and in Space Settlements?

The answers will expectedly be a mixed bag. Without a detailed item by item patent search, it is impossible to say which of Carver's innovations require major secondary ingredients that will have to be imported. Some lines will offer more promise than others, to be sure. But for those interested in honing the edges of the rough early frontier, and making it a more attractive opportunity for settlement, a good deal of scholarly research awaits.

First (and none of this was I able to do at the central Milwaukee Public Library), ✓ get a definitive list of all of Carver's patents, if possible with the dates and patent numbers (but at least the dates); second ✓ look up each patent in question to uncover which processes and secondary ingredients he used in each case.

Some possible RESEARCH SOURCES for you to start with: national, state, and regional Peanut Growers' Associations, Sweet Potato Growers' Associations, etc. The Tuskegee Institute.

Even apart from a detailed look at Carver's work, it should be apparent to anyone observant that crops like the **Peanut** yield diversified products: raw, salted, and roasted peanuts; peanut butters and candies, cookies, and frostings (even milk shake flavorings, and I've stumbled on a soup recipe with a surprisingly complex and pleasing taste!) derived from it. The crushed peanut “cake” (minus the oil which itself is the start of a whole other family of products, some of them industrial) yields flours and meals.

Cellulose-rich peanut shells (36% of the pod weight is here) are a source of fiber – they even come in different hues depending upon soil chemistry. The fiber is not as hard as wood, nor as soft as paper. Peanut shells are also easily turned into a suitable craft material for children's temporary creations, easily recycled later provided any decor materials used with it are kosher (organic and themselves biodegradable like vegetable dyes). They can be cut, shaped, filed and filled, painted, glazed, glued, and strung. Their use on the space frontier for this purpose would help stimulate young creative and artistic imaginations, used in whole or part to make toy people, animals, abstract designs, and jewelry. Even peanut shell sawdust with an organic binder makes a workable child's clay.

The top of the peanut plant is used as fodder along with the press cake of peanut seeds. Does not such a crop, with its promise for food sector industrial diversification, merit serious consideration for a major place on space frontier farms?

The Sweet Potato, Soy Bean, Peanut and other multi-use crops are also key to enriching and diversifying not only space frontier menus, but the whole existence of the pioneers. Those planning lunar and space agriculture have to take off the horse blinders and start looking beyond the salad bar – way beyond! Rather it is the single use crops that should be afterthoughts. This amounts to a revolution in current thinking.

We cannot wait until CATS, Cheap Access To Space, suddenly opens the gates to the frontier to start thinking about these things. The time to roll up the sleeves and put on the thinking cap is now.



Saproculture & Saprochemicals

Fungi, Mushrooms, and some Orchids are among the better-known plants which grow on decaying vegetable matter. Many of these plants are poisonous. In addition to the well known variety known as the mushroom, *agaricus campestris*, there are many other species of mushrooms which are not only edible but almost addictively delicious and delicate. There

seems to be a widespread myth, moreover, that such plants offer empty taste without real nutritional value. Not so!

Where there is agriculture, there will be waste biomass with which to make compost or feed the biodigesters. Why then limit food production to the anabolic photosynthetic part of the biocycle? If food, especially something to add diversity and interest to limited frontier table fare, can be teased out of the biomass decomposition cycle, that makes the whole farming process that much more efficient.

While there is, to be sure, a minority with insensitive taste buds who do not appreciate fungal foods, for the sake of the rest of us there ought to be concerted research on home growing of other mushroom and truffle varieties now mainly picked in the wild. Next you can experiment with ways of serving and preparing your harvest: stewing, sautéing, frying, grilling, stuffing, etc. (The Encyclopedia Britannica under "Mushrooms, Cookery of" even gives a recipe for "mushroom ketchup"!)

Here is yet another space research project for you home gardener types. Our spiritual descendants sitting down around space frontier dining tables will remember you when they say grace.

But let's go one mighty big step further. Wouldn't it be utterly amazing if the various catabolic processes at work in the compost heap or the biodigester did not produce liquors and exudates that could serve as alternative feedstocks for a frontier chemical industry. Here is a whole new field of research for you organic chemists out there. Why not take a stab!



Bioextraction of Trace Elements

In MMM # 63 MAR '93 Lunar Industrialization, Part I, "BENEFICIATION," p4 we tried to stress that the elements present in the "oreless" lunar regolith in major abundances cannot adequately underpin an autonomous industrial base, that we need to learn to efficiently extract other elements present in parts per thousand, parts per million, even parts per billion concentration. This is a tall order for tried and true chemical engineering methods, especially for the lesser trace elements present. There is another tack: Bioextraction.

We can start with soils known to be atypically enriched with the desired elements. Fra Mauro basalts (Apollo 14 Antares mission) are richer in Br, Cl, F, Pb, Zn. KREEP soils splashed out from the Mare Imbrium impact have Cl, Pb, Br, Zn, and Ag on grain surfaces, in higher than expected ppm and ppb concentrations. These are all water-leachable.

Leach water from such soils can then be used to host element-concentrating bacterial and other cultures. Harvested bacterial, microbial, or yeast material would then provide us with an organic "ore", a higher plateau from which to then apply standard chemical engineering methods.

Bioextraction can be piggybacked on the importation of soils into pressurized farming areas, or practiced separately. Either way, it is critical to lunar industrialization.



Arborculture; an alternate path?

A couple of years ago I read a short illustrated piece on something dubbed "arborculture", probably in Popular Science or Popular Mechanics, but I haven't turned up the actual source. In this proposed alternative to "agriculture-as-we-know it," the sole conventional crop grown would be a species of fast growth soft pulp tree.

The harvested pulp would then be finely powdered and, with water added, become a nutritious broth for a wide variety of specially engineered bacteria which would thereupon busily and efficiently produce all the end-use food and fiber tissues and other organic products we desired with near zero biomass waste for extremely high food growing efficiency.

The proposal was not specifically put forward with the space frontier in mind, but the potential suitability should be obvious. Something to keep on the lookout for – **MMM**

7 WONDERS of the Moon

7 WONDERS OF THE MOON: Armchair Pick by Peter Kokh

From orbit, as through any modest telescope, it will be quickly apparent that the Moon offers an unexpectedly diverse landscape. Eye-catching paintings of over-imaginative artists aside, (there are no craggy peaks untouched by erosion and few if any rough edges — all terrain features having been inexorably softened by the eons-long rain of micro-meteorites) this world does have some striking features all the same.

On Earth the rugged awesomeness of crustal rock outcrops and other features forged by a contest between brute geological forces and the relentless onslaughts of an ever active weather system are set in contrast to the beauty of vegetation in wild strobe-like stasis of species competing for niche space. On the sterile and barren Moon there is no such counter play between geological awe and botanical beauty. Moonscapes, however otherwise dramatic or boring in feature, are all of one canvas in being displays of “magnificent desolation” (Buz Aldrin, Apollo 11 landing crew, 7/20/'69).

Many humans are quite insensitive to natural beauty (e.g. “when you’ve seen one waterfall, mountain etc., you’ve seen them all.”) and will react to the Moon in character: “when you’ve seen one crater, you’ve seen them all”. To those of us with an eye for differences and especially to those of us with an appreciation of untamed geological drama, the Moon, which bores only the boring, can boast a wealth of spectacular vistas.

As on Earth, the most spectacular views of the terrain itself will be had from the unobstructed vantage points of high ground — from crater and ridge tops, mountain peaks, rille edges, and promontory points. These overlook craters and walled plains, the frozen lava seas of the maria, straight and sinuous valleys, rolling, cratered, and chaotic terrain etc. As on Earth, there will be sights that merit only local or regional fame, and those that deserve a place on the global honors list.

Here is an armchair selection of nominees for a place on the “Seven Wonders of the Moon” list, the pick of one Earth-bound, telescope-, moonglobe-, and lunar photographic atlas-equipped student of the surface of “Earth’s significant other”. Only five of the Wonders on the list are surface features. Two spots are saved for extra special treats in the lunar heavens.

Five Nearside Wonders of the Moon

1. Earth itself, an apparition in lunar nearside heavens with 3 1/2 times the breadth, blocking out 13 times as much of the starry skies, and shining with 60 times as much glaring brilliance as does the Moon as seen from Earth — all in a spinning ever changing marbled riot of blues, greens, browns, and whites. It goes through the same series of sunlit, night-darkened phases as does the Moon in our skies — with spectacular differences. “New Earth” when eclipsing the Sun during what we interpret as a Lunar Eclipse is a dark circle in the heavens crowned with the fiery ring of the sunset-sunrise line as sunlight scatters in the dust of the atmosphere. The night-darkened portion of the globe is in the last century increasingly “star-studded” with the city lights of burgeoning urban areas and oil and gas field burnoffs of “waste” natural gas and hydrogen. Meanwhile the frequent reflection of the Sun off ocean and ice accentuates the sunlit portions.

Full Earth illuminates moonscapes with sixty-some times as much brilliance as Full Moon brightens Earthscapes. This will be handy for getting about during the long lunar nights. But without a dust and water vapor laden atmosphere on the Moon, Earthshine shadows are

inky black and impenetrable, and starlight is not drowned out. However, for the eye's pupils to open enough to appreciate the starry vistas, the brilliance of Earth must be baffled out of one's field of vision.

While Earthbound students can patiently study a seemingly eternally changeless Moon, lunar settlers and visitors who turn their gaze upon the Earth will have an unending drama of spectacular kaleidoscopic change to admire and study. It will be a treat without the distraction of flora and fauna and weather in the foreground, a Van Goghish canvas of color understatingly matted by black sky and gray regolith.

Astronomical painters such as Bonnestel have tried to help us envision what it will be like to look upon Mars and the various other planets from the surfaces of their natural satellites. But the view from the Moon need take second place to none. Yet not all lunar settlers and visitors will be able to appreciate it with equal ease.

To paraphrase the opening sentence in Caesar's report on the Gallic Wars, "Omnis Luna in quattuor partibus divisa est": "All the Moon can be divided into four parts".

In the central part of the Nearside hemisphere, Earth is either directly overhead or at a very uncomfortably high angle above the horizon. Settlers might aptly nickname these central regions "**the Crooknecks.**" Included is most of Mare Imbrium, Mare Nectaris, Mare Serenitatis, Mare Tranquillitatis, Mare Nectaris, Mare Vaporum, etc.

"**The Postcardlands**" are the peripheral portions of nearside, regions in which the Earth hovers perpetually a comfortable 5–40° above the horizon.

Adjacent to these, straddling the "limb" of the lunar globe, which forever keeps the same side turned towards Earth, are "**the Peek-a-boos**". Because the Moon's axis is not perpendicular to its orbit around the Earth and because that orbit is somewhat eccentric and the Moon travels faster when nearer Earth and slower when further away, all the while rotating at a fixed rate, about 7° to either side of the 90° East and 90° West lines are alternately turned towards Earth and away from Earth. Taken together, the above three regions cover nearly 60% of the lunar surface.

The remaining 40+% is in "**the Obliviside**", the Farside heartland from which Earth is never visible. This fact sets the scene for the last two Wonders on our list.

2. Copernicus. Nearside has many striking large craters. Any amateur astronomer who studies the Moon through a backyard telescope will recognize a couple dozen by location, appearance, and name. And each will have his/her favorites.

Even to the naked eye a few craters stand out a quarter million miles away. During Full Moon, **Tycho** in the mid-south is the radiant point of bright streaks of lighter regolith splash-out that stretch for thousands of miles. Smaller **Aristarchus** catches one's attention with the superimposed brilliance of Venus. **Plato's** dark floor (Academy Plain?) can be picked out just north of Mare Imbrium, the Sea of Rains.

Through the binoculars even more can be recognized. But even though there are sixty-some other nearside craters as large or larger, easily the most striking of all, from Earth, is **Copernicus**. With its extensive debris slopes, it sits alone in southern Oceanus Procellarum, the Ocean of Storms, without neighboring rivals. **Mount Nicolaus*** at its center reveals a glory of detail. [* The author has published his suggestion that crater central peaks be known by the first name of the famous person after whom the host crater is named. They are otherwise known only as "central peak of ..."] A stunning low angle photomosaic of Copernicus taken by Lunar Orbiter 2 in late '66 was billed by the media as the "Photo of the Century". Indeed its psychological impact was without precedent.

Early settlers will have as favorites prominent craters that lie in easy excursion reach of their settlement site. And it will be these that are first offered on itineraries of tourists from Earth. As tourist support infrastructure grows, however, those sights with world-class splendor will be offered. If Copernicus is not handy to the initial settlement site(s), it will soon be reached "by beaten path" nonetheless. In low gravity "sixth-weight" it should be easy enough to build an

elevator-equipped observation room-capped tourist tower 2 miles (10,000 ft., 3 km) high atop Copernicus north rim to showcase the scene.

3. The Straight Wall. In southern Mare Nubium, the Sea of Clouds, lies a 90 mile long escarpment or cliff known as "The Straight Wall". Because it runs north and south, it is cast into high relief by the rising Sun and is very prominent in even a low-power scope a day after first quarter (first or waxing Half Moon). While the "wall" is not really that high, this sunrise shadow play can be appreciated from surface viewpoints as well, especially those above the average elevation of the plain to the east [a mischievous use canonized by astronomers. The thought never crossed their ivory tower minds that the orientation of people on the surface might someday matter. What is the "eastern" hemisphere of the Moon as seen from Earth is really the "western" hemisphere from a lunar point of view as determined by the progress of sunrise and sunset.]. This feature probably does not deserve a thousand mile detour, but it is unique and special enough to be on the itinerary if established trade and travel routes pass nearby.

4. The Alpine Valley. Running like a canal through the mountainous terrain between Mare Imbrium and Mare Frigoris a couple of hundred miles east of Plato is an arrow-straight cut or trench, probably made by a massive piece of ejecta from the impact explosion that carved out the Imbrium basin. About a hundred miles long, it is sure to be a mainline route for traffic and utility lines between these two mare areas. All along the route there are high points to either side which must offer quite a vista. Some of these may one day host tourist lookouts, rest stops, and hotels.

5. The lavatubes. While we have strong evidence such features exist and in what kind of lunar terrain we are likely to find them, we have yet to actually map, much less explore, even one. These cavernous wormholes made by subterranean rivers in the still cooling lava floods that, layer upon layer filled most of the Moon's larger impact basins over three and a half billion years ago. Some near surface tubes have partially or wholly collapsed to form broken or continuous sinuous rille valleys, for example, Hadley Rille, visited by the Apollo 15 crew. But many others must lie intact, invaluable geological preserves as well as handy shelter for the more volume-hungry needs of lunar settlement and industry. Lavatube exploration is sure to be an honored lunar "outlooks" activity.

Two Farside Wonders of the Moon

6. The Milky Way. One of the lesser recognized ways in which we are allowing our terrestrial environment to continue to degrade is urban nocturnal light pollution. Today there are millions of youth who have never seen the Milky Way. For those of us fortunate to live in or visit at least occasionally countryside areas well outside built-up populated areas, the sight of the Milky Way in dark star-bedazzled skies is unforgettable. But we glimpse it at the bottom of an wet and dusty atmospheric ocean. Even in mid-desert where on cold crisp nights the seeing is best, we are somewhat handicapped.

On the lunar surface, atmosphere is absent. But anywhere in the Nearside Crooknecks or Postcardlands, and part of the time in the Peekaboos, there is the distracting brilliance of Earthlight which must be baffled not only from view, but from reflection on one's helmet visor.

It is in Farside during nightspan, both Earth and Sun below the horizon, that the Milky Way shines in full, undam-pened, unchallenged glory. To look up from such a vantage point and scan this river of starclouds as it arches across the heavens from horizon to horizon is a treat no human has yet experienced. For those with soul enough to appreciate it, this awesome sight will be a, for some the, reason to visit, or settle in, Farside. Many will choose the peripheral Peekaboos along the limb, for in these areas one can enjoy both the Milky Way, and Earthrise/Earthset, alternately.

7. Tsiolkovsky. The standard approach and landing trajectory that ships bearing settlers, tourists, and visitors will take to surface settlements will bring them in on a descent swing around Farside. Mare Orientalis, the dramatic bullseye-shaped Eastern Sea (misnamed because it is in the western Peekaboos) will be the feature most watched for, if, of course, it be sunlit at the moment. But deep in Farside, again depending on the time of sunth, another spectacle awaits them, to this writer's eye the most dramatic crater on the Moon — Tsiolkovsky, aptly

named after he who taught us that Earth is but our cradle, and that it was our destiny to move up, out, and beyond.

Like Plato and Grimaldi on Nearside, Tsiolkovsky's basin is flooded with mare-like deposits — in its case some of the darkest mare regolith to be found anywhere on the Moon. This only serves to set off even more strikingly the **Mount Konstantin** massif that dominates Tsiolkovsky's interior. What a perch for a monastery or Shangri-la!

If the day comes when human settlements in the solar system organize in some politically cooperative way, what better site for a capital or headquarters than on Tsiolkovsky's dark flat floor south of the Konstantin massif. It is handy enough to Earth where most of humanity will continue to live for a long time to come. Yet its horizons face away from the hidden cradle world out upon a Milky Way crowned universe of unlimited opportunity. And who could pick a better name? It's frosting on the cake that those approaching from space could pick it out instantly by naked eye a half million miles out

National Parks and other Preserves

Any discussion of great natural wonders would be incomplete without considering what we might do to preserve such heritage. **Scenic Preserves** would establish regulations restricting buildings, road placement, and other developments in the foreground or background visible from scenic overlook sites. **Geological Preserves** would go further, protecting not only specific viewpoints but the physical feature itself from development, some types of mining, etc. Designation as a **National Park** would signify the intention to develop tourist and other recreational use facilities nearby so that the feature could be popularly enjoyed in a controlled fashion, as well as preserved from other types of development.

There is the added question of preservation of scenic orbital perspectives, i.e. of preventing developments that might be defacing on a large scale. Given the impotency of efforts to control forest clear-cutting in the Pacific Northwest where ugly scars that seem to grow cancerously insult anyone peering out an airplane window, lunar authorities will have to insulate themselves from the palmgrease of developers if they are to have any luck. But solving the future's problems is the chore of those alive at the time. We can but warn. **MMM**

MMM # 74 April 1994

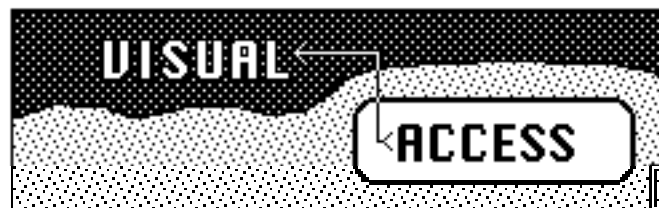

READINGS From Back Issues:

[Republished in MMM Classics #1] MMM # 1 DEC '86 p 2. "M is for MOLE"

[Republished in MMM Classics #6] MMM # 55 pp.5-6 visual access (lunar skyscraper article)

VISUAL ACCESS By Peter Kokh

The one single event that got me most excited about the possibility of lunar settlement was an '85 personal tour of a unique "earth-sheltered" home called Terra Luxe (Earth Light) about 30 miles northwest of Milwaukee in the Kettle Moraine glacial relic area. Built by architect George Keller (German for cellar), Terra Lux is unique in having no sun-exposed south façade. Yet despite an earthen overburden 8 ft. thick, the place was flooded with sunlight from mirrored shafts in the ceiling fed by sun-following mirrors. More to the point here, in every outside facing wall was a 4'x8' picture window out on to the picturesque countryside. This neat trick was accomplished by a pair of rectangular mirrors set at 45° angles in a vertical shaft:

“periscopic picture windows” so to speak. To this date, I have never been in a house so refreshingly wide open to the land-scape all about as here at Terra Lux.

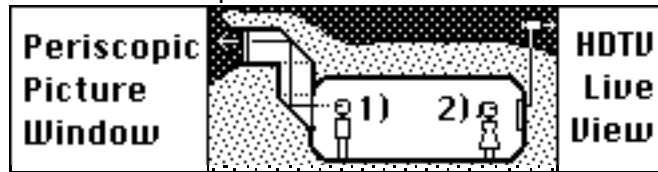

Could such a system for real visual access be in some way adapted to lunar conditions? Why not? The glass used could be reinforced with transparent glass fibers (in lieu of lamination with plastic, as we might do here) and be some-what thicker – we would want to reduce the brilliance level anyway. Then there could be a pair of horizontal panes at the bottom and top of the vertical shaft (see dotted lines in sketch above) to allow the atmospheric pressure between them to be gradually stepped down to reduce the stress on any one pane, e.g. 0.25 ATM, 0.5 ATM, 0.75 ATM (or similar percentages of whatever the interior habitat pressure was set at). Finally, an easily replaced “sacrificial” glass composite meteorite shield can sit in front of the outermost pane of the sealed periscopic unit. The “Z-View” unit would preferentially have north or south exposures so as not to admit the rising or setting sun (unless equipped with automatic (hence failure-prone) shutter system). Meanwhile, the indirect visual path would preserve full line-of-sight shielding for the habitat occupants.

It would seem that such fixed units with no operating parts would be both strong enough and well enough protected to be built in genuinely “picture window sizes. These units could be standardized preassembled tested modules made to be snap-installed in standardized habitat wall “rough openings”.

Of course, there is the electronic solution of thin, hang-on-the wall ultra-high-definition television view screens (“you can’t tell it from real” will go the hype) for those who dislike KISS (keep it simple, stupid!) solutions and who can trust that the signal received is coming in untampered, and live and that neither their “window sets” nor the surface telecams that feed them will ever break down and need costly repairs. I’d like to see both options pursued and predict that both will find ample market share in a growing settlement.

A third solution is the cupola observatory. Here direct views of the surface are afforded while maintaining a very limited sky exposure, thanks to the generous shielded eaves.

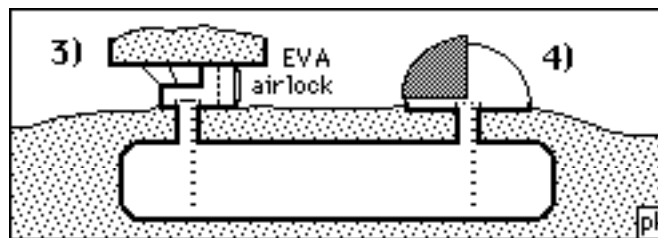

A fourth solution is the surface dome, with a clock-driven sun-following shade screen. This would open the view to the star spangled sky, and to Earth for homes on nearside. The penalty, of course, would be accumulated cosmic ray exposure and thus the need to budget time spent therein.

Perhaps some would expect visual access to be a neurotic need of the few unadjusted persons. Who needs to be reminded of the hostile life-threatening radiation-scorched surface when interior spaces can be made so comfortable and reassuring. But I suspect lunar settlers will come to appreciate the unique beauty of the magnificent desolation outlooks and enjoy monitoring whatever surface activity there is outside their safe underground homes. Providing real-time true vision exterior visual access to all will promote acculturation to the Moon and a healthier, more balanced morale. **MMM**

A reasonable man adapts himself to the conditions that surround him.

An unreasonable man adapts the surrounding conditions to himself.
All progress depends on the unreasonable man. – George Bernard Shaw

From now on, we live in a world Where men have walked on the Moon.
And it wasn't a miracle! We just decided we wanted to go. – Jim Lovell, in "Apollo 13"



Letting in the glory and warmth of real Sunlight

SUN MOODS By Peter Kokh

READINGS From Back Issues:

[Republished in MMM Classics #1] MMM # 1 DEC '86 p 2. "M is for MOLE"

[Republished in MMM Classics #3] MMM # 27 JUL '88 p. 5 "Ventures of the Rille People: Pt. II Rille Architecture General Concepts. D. Letting in the Sun"

[Republished in MMM Classics #5] MMM # 43 MAR '91 p. 4. "Dayspan"

[Republished in MMM Classics #7] MMM # 66 JUN '93 p. 7. "Let there be LIGHT"

On Earth we take sunshine for granted. Not that it's always there! Nor that we don't appreciate a nice sunny day! But the point is, we get to go outdoors and bask in it, at least once in a while. On the Moon, the Sun shines gloriously, free of even a wisp of cloud or haze, for fourteen and three quarters days at a time, before setting for as long. One hundred percent predictable, but! We can't go "outdoors" to enjoy the brilliance it confers on everything nor its warmth on our face or back – not without cumbersome space or pressure suits. Nor will it automatically flood in through simple windows.

Two things are clear. We will have to enjoy the Sun indoors, and we need its rays to bathe us, and our living space from above. Living underground, or under 2–4 meters (yards) of lunar regolith shielding, one might expect that to be a neat trick. Not really. Sunlight can be captured by a Sun-tracking mirror or heliostat and then directed via a broken path (to preserve line-of-sight shielding) to various points along the ceiling (or walls, if deflected upwards). Such a pathway can have a number of intermediary sealed panes to step down the interior pressure, just as in the Z-View window system described in the piece above. Option a) below.

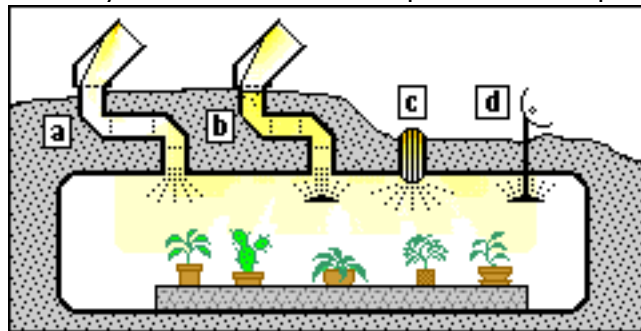

Option B is similar but the light is deflected against the ceiling. **Option C** uses a smaller diameter direct path filled with bundled glass fiber-optic strands in a sealing matrix. This also preserves shielding, substituting glass for dust. It could be coupled to a heliostat or not. The bundle can just as easily be branched to produce little pools of built-in spot and mood lighting at various places within the habitat. As such, it would be an important part of architectural decor and setting.

Option D produces electricity from a solar unit at the surface and regenerate “sunlight” electrically within the habitat, faithfully repeating the visible spectrum distribution and intensity. Artificial sunlight does work! I have seen convincing “skylights” in the basement ceiling of a seven story office building. The light pools beneath them mimicked bright sunlight quite effectively. Over-illumination (compared to comfortable reading and task lighting) is as much a key as color fullness. So this option is a possibility where direct funneling of true sunlight is impractical: in lower floors, in lavatubes, and during nightspan. Actually, even where directly channeled sunlight is quite feasible, the natural and artificial systems can be combined, with artificial “sun lamps” on the surface feeding sunlight delivery systems during nightspan.

Over-illumination, is itself quite therapeutic, flooding interior spaces with all the light you’d experience in the middle of a Kansas cornfield on a late June noon under a cloudless sky. Such intense lighting can be applied in garden areas, for example; or in a private meditation chapel, or public church, filtered through stained glass art panes.

So far, we have only spoken of ways to bring the sunlight into the interior of hard-hulled regolith-shielded habitat spaces. But the upper portion of a habitat module can be made of translucent glass composite, with the shielding provided by glass blocks. That much glass would cut down on the amount of light being transmitted appreciably. But if desired, this loss could be compensated by reflecting several suns’ worth of light upon the outer surface with the aid of peripheral mirrors. Below right

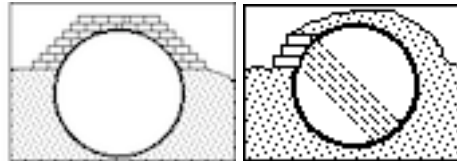

Above: A combination of conventional and glass block shielding is a more modest possibility; for example, a clerestory of glass block used on the sun-facing bank of a structure running east-west.

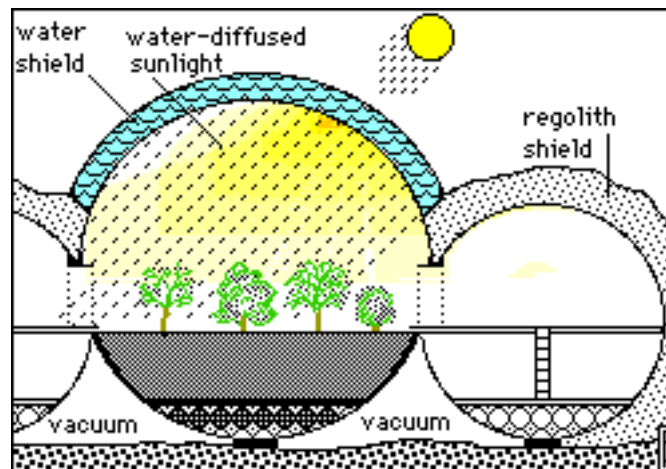

Above: A more ambitious project is to use water shielding over a glass-domed or vaulted garden-atrium or farm module. We need to store reserves of water at any rate, and storing it overhead as translucent shielding is a Marshall Savage suggestion that deserves attention. This combo fresnel lens bottom water skylight/solar hot-water tank is our own idea. In “The Millennial Project,” p. 209, Savage suggests circulating the water through cooling tanks to keep the water shield under thermal control. Our more modest version.

MMM # 76 June 1994

Windows – out with one cliché and in with another

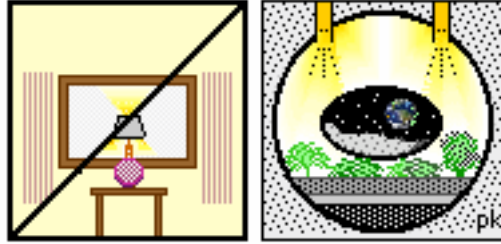

[L] Here on Earth, driving along at night, one sees home after home with a lamp on a table in front of a picture window. Poor decorating perhaps, but quite commonplace.

[R] On the Moon, with very little pedestrian or motor traffic “outside,” exterior presentation will have a low priority. Ranking higher will be the inner need to gaze at the stark and sterile moonscape Through the reassuring foreground of living foliage and flowers, under solar spotlights [R]

MMM # 77 July 1994

“Art du Jour”

Temporary Creations of Lunan Settler Children made of organic craft stuffs from farm & garden. and meant, with rare exceptions, to be recycled

To foster artistic talent in the young, it is important to supply them with “play-media” upon which to exercise their talents. For this purpose, organic stuffs derived from garden and farm might be permitted a short-term detour en route to their recycling back into the biosphere via biodigesters or other routes. Natural dyes can serve to develop painting talents upon easy-to-recycle simple recyclable papers. Potatoes and bars of soap can help develop carving talents. Beeswax and putty made of flour, water, salt, and baking soda can stir in them the talent of the potter. Corncobs, husks, seeds, kernels, nuts, eggshells, peanut shells, bones and even hair clippings are things with which to make dolls, toy characters, and other “neat stuff”.

Parents proudly display their children’s creations, and often put them on display, where they will be noticed by any visitors. But save for exceptional samples, most of these loose whatever encouragement value they may have rather quickly, given youngsters’ usual swift progress. They can then be recycled back into the biosphere, having served their purpose. Eventually, those who have displayed talent worth encouraging further can be weaned from these media, graduating to the inorganic art media that can be supported by the settler economy, reliant on local resources.

In addition to organic stuffs for “art of the day” creations, school students may have access to sundry other items at the start of the recycling pipeline. Sculpture made from scrap metal, glass, ceramics, and other inorganic materials, if prize-worthy or salable, can be left intact permanently with little or no ill effect on the economy.

And if, as we’ve suggested, older children are charged with the creation and production of toys for younger ones, this may develop their entrepreneurial talents as a bonus. **MMM**

MMM # 80 November 1994



Lunar settlers will be able to “paint” using only materials derived from the regolith soil around them!

Above: “Moon Garden #1,” reverse painted on an 8”x10” piece of glass, by MMM Editor Peter Kokh

The “paints” are not solvent based and incorporate no organic substances even as additives. Instead an inorganic adhesive (the only one known), sodium silicate is used to suspend either raw regolith powder or colored metal oxide powders. The palette is still limited and the art form undeveloped. More candidate lunar-sourceable colored powders are sought, as well as other artists, with more real talent to push the new medium to the fullest.

MMM # 90 November 1995



GOOD HOUSEKEEPING INCLUDES SITE MANAGEMENT By Peter Kokh

It’s simple, really. We just plop down a basic habitat module and throw some moon dust over it for good luck, add some solar panels or a small nuke, a radiator, an antenna, and a rover — and, voila, we have a Moonbase! Whoa! Doesn’t that leave a lot of unanswered questions? How will our little baby develop? Are we going to be so quick to show around the latest snapshots of our offspring a few years down the road?

Will future growth and development of our little bundle show that it had “good genes”, or “bad” ones? A well-thought-out site management philosophy with a full deck of guideline zoning protocols, in place from day one, will help guarantee that we will be proud parents, not just shortly after birth, but well down the road. That’s adding “good genes”. If we fail to do this, or put it off as unimportant, the future of our creation will be “amorphous”, and since corrective and reactive measures are never as effective as proactive ones (and always too late), an

unhappy McMurdo-style mess is sure to result if we don't care enough now – while we are planning.

If a definite site, mapped from orbit down to near meter scale detail, has been predetermined, then our site management plan can be quite specific in its initial design, with zoning of the immediate vicinity well thought out. One would hope this is the case.

If, however, we have only a general location in mind, we'll leave picking the actual site up to the good judgment of the pilot of the lunar descent vehicle bringing in the first load, then all we can have prepared is a manual on the "General Principles of Lunar Base Site Management." This is how the Apollo landing sites were picked: neighborhood by NASA, block and lot by the LM pilot. It's unlikely that this will be the case the next time around, when we go to the Moon, not for a science picnic, but, hopefully, to start a settlement.

We'll probably even have ready a name for the host site, our new neighborhood, as distinct from the name of the outpost itself, e.g. Pioneer Flats, Artemis Beach, New World Plain, Dawn Valley, etc. Perhaps some of the names will reflect who donated how much cash to the project.

The important thing to remember is that no matter how much individual pioneers and scouts may care, without a pre-agreed-upon and then religiously pursued game of site management, chaos will inexorably insert itself. Once allowed a chance to rule, chaos takes on a powerful life of its own. Witness McMurdo Sound in Antarctica, before Greenpeace photographers shamed us before ourselves and all the world. Compare cities that have grown up with a reference master plan and those (Third World villages-become-infrastructureless-megacities, and, to be fair, many a European medieval city as well) that suddenly mushroomed like cancerous weed patches.

Basic Principles

An outpost is more than an architectural complex that we are going to put there, snap its picture, and then leave as a monument. It is presumably a nucleus from which long term "operations" will flow. These operations will impact the site. We need to give as much thought to fitting operations to site as we do to the design of the bent metal of the outpost itself.

At the same time, it would be naive to assume we can accurately pre-glimpse the full range of activities that will characterize our lunar presence down the road, as base becomes outpost and outpost becomes village and village becomes a settlement town. Our site management philosophy and game plan must necessarily be amendable. What we need is something to start from, a handbook of "how not to paint ourselves into a corner". And that is not that tall an order.

Perhaps others will have something to add to this recipe for a lunar beachhead site management master plan, but at least a first stab at it would seem to indicate we need to make room for the following: (a) terrain to be left relatively undisturbed, for scenic and esthetic reasons; (b) roadway approach corridors; (c) sites for auxiliary equipment: electric power generation, heat rejection radiators, communications equipment, spaceport, garaging of vehicles, etc.; (d) storage and warehousing of surplus equipment, wastes and potentially recyclable trash, cannibalizable packing & shipping materials; (e) areas where the regolith can be "mined" for useful elements; (f) initial industrial park set-aside; last but not least, (g) vectors for expansion of the residential and other structural parts of the outpost itself.

As/if our presence expands by orders of magnitude, the site plan for the perimeter of the base will have to give way to newer plans that embrace ever larger and larger peripheral areas. No problem – if the original plan has good genes.

Esthetic Zoning Protocols

While many a technician or scientist or engineer lucky enough to be part of the original short term crews may not care, the morale both of those who will come for longer stays, and of the millions of supporters at home who will per over their shoulders electronically, vistas out the windows of the outpost observation domes (or whatever) ought to show both human

(thoughtfully) transformed areas as well as broad expanses of “magnificent desolation” that are minimally disturbed (or restored). In planning the site, we need to be aware of what areas are in sight from outpost “windows” and what areas will be within the horizons of those coming and going between spaceport and outpost. We need to know which areas of high ground will be broadly visible, as well as which areas will be hidden from view of the window ports of either outpost or spaceport coach. Some of this can hopefully be left in its undisturbed state, visitable from sinter-paved walks or trails. Other parts of the perimeter, necessarily disturbed in the base erection and deployment process, or in base expansion, can be “restored”, regraded and raked. Additional handsome areas can be Japanese style sand and rock gardens, or sculpture gardens – the start of uniquely lunan urban/rural “landscaping”.

Scenic “easements” cannot be left for afterthought, even in latter expansion of the site. Making provision for them will not make setting up our base or outpost any more expensive. It will simply require a bit of timely patience.

As mining operations begin, the availability of large volumes of tailings for the creation of man-made hillocks or embankments to shield storage and equipment areas from casual view will create new options. That we are fairly certain such activities and opportunities will develop, we can take into consideration the availability of tailings in devising the scenic provisions and easements of our overall site plan and its subsequent revision as the base-to-settlement unfolds itself.

Thus we will have both natural and human-landscaped areas. For either, the availability of cleared boulders, shards and other debris becomes so many opportunities for the lunan landscape architect.

Lunar “parklands” and scenic preserves need to be part of every expansion of the radius of operations. With such a philosophy, travelers, visitors, and vacationers will never need to be assaulted with the ugly exposed entrails of our industrializing impact on our adoptive new home world.

Storage and warehousing areas, mining and industrial can be out of sight behind scarps, crater walls, ridges (natural or man made), hills, berms, in lava tubes, under ramada sheds, etc. The same goes power generation, heat rejection, and other necessary systems, unless architecturally complementary to the moonscape. After all, we will need to be visually reassured of the presence of both the technical and biospheric support ecosystems for maintenance of our presence on this, of itself, alien world. We need to see both the undisturbed beauty, and evidence that we are supported in our needs. The point is that the latter need not be presented chaotically and in disordered fashion. A basic set of esthetic zoning protocols will do the trick. The up-front cost will be minimal. Down the road, such foresight may become a definite economic plus.

The idea of **lunar “landscaping”** should be taken seriously by Earthside supporters with ready creative instincts and experience. We can’t go around planting “evergreens” or other trees, bushes, and flowerbeds. But we can do something analogous, assist in the “blooming” of the lunar soil, by bringing into being various human-midwived extrusions of surface materials. This is not so unlike what Nature does as it brings out various life-midwived extrusions of the geological elements on our own planet.

With mining tailings and other material leftover from road grading, cutting passes through ridges or crater walls etc. it will not be impossible to create what until now have only been fantasy mountainscapes of craggy peaks etc. In lieu of flower beds, we can boulevard or “tree-line” our main settlement approaches with crystal glass snowflakes, ceramic stalagmites, and other roadside sculptures meant to be panned in passing. Roads can also be curbed with split and possibly polished breccias and other lunar “rocks” displaced in the grading process. Nor are we stuck with a palette of grays. We can whitewash with lime (Calcium Oxide) or with Titanium Dioxide, even Aluminum Oxide. We can collect the iron-rich orange soil found first at Shorty Crater, and more recently all over the place by Clementine, and use it in concentrated

form to give areas various tints from rust to orange to cantaloupe. And a sprinkling of sulfur could provide a yellow.

Sculpture forests can be planned so that they take on whole new aspects as the Sun slowly marches across the lunar dayspan skies. Trees? Why we have already made trees of aluminum and aluminum foil for Christmas time. Why not sculpture “trees” which are outgrowths not of life, but of the inner potential of aluminum, iron, magnesium, and glass? They could be made stiff and immutable, but why not also with fairy gossamer “leafage” to flutter in the “breeze” of changing sunlight angles and mutual shading interference. “Trees” and “bushes” can be modular in construction using controlled “natural” randomization to vary size and branching patterns and nature-like deviations from symmetry. They could be laden with glass prism fruit to cast an ever-changing pattern of rainbow colors. Let your imagination soar. This won’t happen all at once, but give it time!

At night, UV and Neon lighting will eventually be lunar supportable options. Even passive electro-fluorescent lighting, driven by the sun angle and or occasional solar flares – to give an ever-changing ambiance – is a possibility.

Road embankments can be dressed with cast basalt or ceramic tiles with various textures and designs. “Pebbledash” panels are also a simple option.

In short the resources of the future lunar “landscaper” know few bounds. The point is leaving thoughtfully saved zones and sectors for him or her to give creative expression.

Other Zoning Protocols

Last month, in our article on “Dust Control” [MMM #89 pp. 5–6] we discussed the wisdom of sintering (lightly fusing the surface grains to a load-appropriate depth) aprons around airlocks, and of sinter-paving areas of regular traffic (roads) and areas of regular, routine activity such as areas where exterior systems are placed, or exposed or sheltered “lee” space storage areas for items needed on a frequent basis – the purpose being simply dust control. This can be guaranteed by carefully drawn up zoning protocols and guidelines.

Storage and Warehousing Protocols

We will discuss this topic at length in the article that follows. The old adage, “a place for everything and everything in its place” is the guiding philosophy we must devotedly pursue if we are to keep chaos at bay. Do not provide each category with a storage place of its own and voila, you have instant unrecoverable disaster, a good example of which is the Manifesto office where this is being written..

Growth Vectors – the Site Plan

While surely we will add new modules to the original outpost complex, it is unlikely that, as we move from outpost to pre-settlement village, and then on to settlement town, that we will just keep adding on. We may want to identify areas of the surrounding Moonscape for starting afresh, for example, once we are able to use made on site building materials to take care of the bulk of our expansion needs. In time the original imported outpost transplanted from factories on Earth may be decommissioned and transferred to other uses: a spartan ‘hotel’ for early visitors, or preserved “as is” as an “historic park”.

Any new “village” or “town” needs to have a plan for expanding residential, agricultural, commercial, industrial, service, educational, administrative and other zones, properly separated, properly intertwined and interspersed, neighborhood after neighborhood, as we grow. We certainly do not need to set out from Earth with such a City Plan already brainstormed in detail. We simply need to be armed with a plenary set of principles, if even in library form.

Exclave Concessions

We should not think of the Moonbase Site as encompassing a single contiguous area of set radius from our starter outpost. Depending on the legal regime(s) that may apply, our “concession” or “charter” may designate a fairly generous radius, more and more of which we will occupy and transform as time goes on.

But if we are to move in the direction of providing for an ever larger portion of our material needs as well as export potential through the use of resources indigenous to the Moon, then we may want/need to range further afield to access special deposits of minerals not found within the original site radius.

If we pick a “coastal” site, astride a boundary between highland and mare terrain, this will give us immediate access to the two major regolith soil groups. But we will still need to have access to KREEP (potassium, rare earth elements, and phosphorus) deposits such as those represented in the splash-out from the formation of the Mare Imbrium (Sea of Rains) basin over three billion years ago. Central peaks of larger craters represent a fourth suite of minerals. And then we may find Sudbury like astroblemes rich in asteroid-impact-donated lodes of iron, nickel, and, more importantly, copper.

Thus we will need to set up “Exclave Concessions” as well and provide and maintain traffic corridors to such out-sources as well as to other destinations like additional (rival or secondary supportive or dependent) outposts and settlements. Each will need its own Site Management Plan. **MMM**

MMM # 94 April 1996

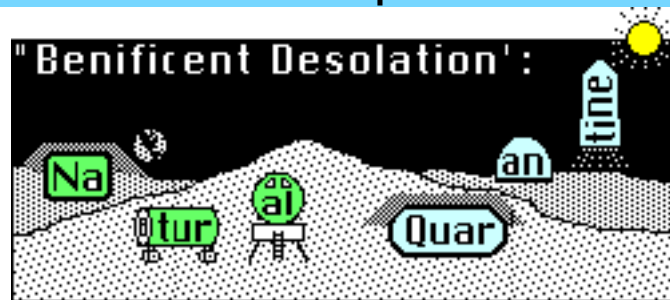

The Lack of a lunar global biosphere has a silver lining BENIFICENT DESOLATION OFFERS NATURAL QUARANTINE By Peter Kokh

Relevant Readings from Back Issues of MMM

MMM # 8 SEP '87 "Colonists I.Q. Quiz": Q. 6 [Classics #1]

MMM # 15 MAY '88, "Rural Luna" [MMM Classics #2]

MMM # 56 JUN '92, p 5 "Quarantine" [M3 Classics #6]

MMM # 79 OCT '94, pp 13-15 "Lunar Roads"; "Waysides, Service Centers, and Inns" [Classics #8]

MMM # 83 MAR '95, p 5 "Tarns" [MMM Classics #9]

MMM # 84 APR '85, p 5 "Ghost Towns & Ruins"

On Earth “the” biosphere is continuous, integral, and all-embracing. On the Moon, each settlement and outpost must maintain its own discrete minibiosphere, and do so very caringly. Lunans will live essentially and immediately, “downwind and downstream from themselves”. No global air circulation to diffuse pollutants, no shared ocean or boundary-defying groundwater aquifers to pollute. On the Moon, the great barren sterile out-vac will maintain a virtual mutual quarantine between all the several settlements and outposts.

Locally this discontinuity can be ‘postponed’. It will make no sense to have separate town center and suburban biospheres. Everyone living within feasible connection distance will seek to be inter-connected. And there is virtue in this. The bigger the biosphere, the more stable and forgiving and satisfyingly rich and diverse it is likely to be, both in decorative greenery and in food and fiber producing plants. That does not mean there may not be separate political autonomies with their own little school district and zoning peculiarity fiefdoms etc. But

the important thing, the biosphere, will be a shared metropolitan responsibility. There may be some few separate neighboring installations, but these will be industrial facilities where prudent separation is maintained in case of a potentially polluting accident.

The biological quarantine that will reinforce the separateness of discrete outpost and settlement biospheres will offer an important plus. We've never built / developed / grown mini / artificial biospheres before, and the risk of biological collapse through imbalance, disease, or mismanagement will be higher than we would like – certainly for several generations to come. The provident availability of quarantine through the aegis of surface vacuum and the absence of groundwater will provide distributed, rather than shared vulnerability.

If there is disease or wholesale biological collapse in any one given minibiosphere, the chances of containing it there locally are greatly enhanced by this quarantine. Infection can be carried in by both travelers and visitors, of course. But the odds of prevention are clearly enhanced by this separation.

Another benefit of this natural quarantine is that the town fathers and citizenry in each case can choose their own flora and fauna combinations, their own climate and regimen of seasons. "See one lunar town, and you've seen them all?" No way! Each can have its own natural ambiance, enhanced by differences in city plan, prevalent architectural styles, etc.

This quarantine-enabled variety will not only make the Moon a more interesting place for terrestrials to visit, it will draw the visiting Earthlubbers to visit more settlements, not just the main one(s), distributing income from tourism more fairly. Towns will choose their floral and faunal mix as well as architectural styles and other elements of distinctive and alluring ambiance accordingly.

For Lunans themselves, the result will mean realistic possibilities to "get away" and experience wholesome "changes of scenery" on vacation holidays as well as in business travels. Those needing to relocate and start their lives "over", will have the chance to do so. As on Earth, Lunans will be able to relocate for "life style" reasons.

The desolation of the out-vac is not only "magnificent", it is truly "beneficent!" **MMM**

MMM # 95 – May 1996

Mother Earth" – of course! – But "Mother Moon"?

Earth's Atmosphere ↑

The Moon's Regolith layer ↓

2 distinct, yet analogous types of "Cradle Blanket"

By Peter Kokh

On Earth we live on the interface of a land-sea surface and a generous atmosphere. At the bottom of this gaseous ocean, temperatures are greatly moderated, and most of the life-frying radiation that permeates outer space is filtered out – in particular solar ultraviolet and the high-energy particles of solar flare storms. The atmosphere serves as a protective "cradle blanket" for life on Earth.

Much has been made of the absence of such cradle blankets on other worlds in the solar system. Venus' atmosphere is crushingly thick, with a surface pressure some 90 times that to which we are accustomed. What's more, it is extremely hot, sulfurous, and unbreathable.

Mars' thin atmosphere is enough to support wispy clouds and occasional dust storms, but does a poor job of insulating the surface and filtering out harmful ultraviolet. On the plus side, it is thick enough to allow fuel-saving aerobrake landing maneuvers, even thick enough to allow for aviation to become a major avenue of transportation in the opening of the planet's extensive frontier, equivalent to the land area of all Earth's continents. Yet for thermal insulation purposes and UV protection, Mars is functionally as airless as the Moon.

On the Moon and Mars, we will have to live in tightly pressurized habitats, and protect them with thermal insulation and radiation absorbing mass – either in the form of a piled up overburden of loose surface material or by placing our habitat structures in handy subsurface voids like lavatubes.

Fortunately, on both worlds, meteorite bombardment through the ages has built up a convenient surface layer a few meters thick of pre-pulverized material that is readily available for this purpose. This layer is called the “regolith” [Greek for blanket of rock]. Largely rock powder, it contains larger rock fragments and a considerable amount of tiny glassy globes that have resulted from the heat of meteorite bombardments.

While lunar regolith occupies the same physical site as topsoil on Earth, there is an enormous difference. Earth's topsoil is principally derived from wind and water erosion, which leaves the particles rounded, not rough and angular like the “unweathered” grains in moon dust. Terrestrial topsoils have varying but significant components of hydrates (water-bonded minerals) and of carbon-rich organics (decomposed plant and animal matter). They are also rich in nitrates.

Nor on the other extreme, can regolith be compared to relatively inert beach or desert sands. Sands are mostly silica, silicon dioxide. Lunar regolith is metal-rich in comparison.

In essence, we have to burrow under this rock powder surface blanket. We will live and operate largely not “on” the visible surface at all, but once again on an “interface,” this time between the fractured bedrock substrate and the powdery moondust top layer. Just as on Earth, we will survive and learn to thrive “tucked under a blanket” that provides thermal insulation and UV/Cosmic Ray/Solar Flare protection.

The regolith promises more than that. Its pulverized state makes it a handy and ample pre-mined endowment of the Moon's mineral resources. Lunar industrial development will build on this ready resource. More, having lain on the surface for eons, the regolith has soaked up incoming solar wind particles like a sponge. So it offers us gaseous wealth as well.

For thermal and radiation shielding, regolith can be blown, dumped, or bulldozed over our habitat structures. We can put it in bags to use for the same purpose but with greater convenience. Vibration compacted and then sintered by concentrated solar heat, it becomes a low performance solid (“lunacrete”) that can be used for paving or as blocks for constructed unpressurized outbuildings, or for decorative interior walls. Flocking regolith on molten glass as it is shaped, or on ceramic greenware before firing may make for an interesting artistic effect. Sifted free of the more finely powdered grains, it may make a suitable soil or rooting medium for both geponics and hydroponics food production.

Finally, regolith will “give up” some of its valuable elements very easily. Pass over it with a magnet to extract all the pure unoxidized iron particles (“fines”). Apply heat and extract all the adsorbed Solar Wind gasses: hydrogen, helium, carbon, nitrogen, neon, argon, xenon, krypton. Other elements (oxygen, silicon, aluminum, magnesium, calcium, and titanium and other alloying ingredients) can be extracted with more difficulty through a number of known processes.

Regolith seems a strange name. Pioneers may shorten it to **‘lith** (‘lith shielding, ‘lith-scaping, ‘lith-moving equipment, etc.) By whatever name, it will play the major role in shaping lunar civilization and culture. For moondust is another very different yet analogous kind of cradle blanket. It will effectively tuck us in, motheringly, on the Moon. **MMM**

The Unending Vigilance for

Fresh Air

“Mini-biospherians will live just downwind and downstream of themselves.”

“You can’t just open the window and let in some outside fresh air.”

“We can’t go, if we can’t breathe.”

By Peter Kokh

Relevant Readings from Back Issues of MMM

MMM # 36 JUN '90, pp 3–5 “Biospherics”, D. Dunlop

MMM # 51 DEC '91, p 3 “Everfresh”; p 4 “Fire Dept.”

MMM # 52 FEB '92, p 5 “Dept. of Xity Biosphere”

The sealed window

Most of us hopeful and expectant that humanity will indeed spread off planet, have a very unrealistic idea of the difficulties we will have to overcome if we are in fact to be able to successfully engineer and maintain micro- and mini-biosphere environments that work, and work forgivingly, long term. Here on Earth when the inside air becomes too polluted from the outgassing of organic and synthetic building materials and from the chemical household maintenance products upon which we have become dependent, we have but to open the window and let in the relatively fresher outside air.

Outdoors, when air quality is bad, we know that sooner or later the wind will bring us relief. In space and on the Moon, even on Mars – anywhere in the solar system beyond Earth’s mothering atmosphere – we will not be able to simply open the window, and there will be no outside winds. We will have to deal with the problem, principally by not allowing bad air situations to arise in the first place.

Outlawed items

Not to burden the air with pollutants that may be hard for many to handle in closed quarters, aromatic substances in general may be proscribed in more than subliminal quantities. Anecdotally, this will mean relying on honest hygiene as opposed to masking colognes and perfumes. Even in very small doses, in closed environments where there is no inside–outside air exchange, consciously detectable fragrances may become oppressively suffocating to many.

All materials outgas, synthetic materials especially so. Fortunately on the Moon, there will be little use of such materials for economic reasons. They can’t be produced from locally available material stuffs, and importing them, or their stuffs, will be prohibitively expensive. This will make lunar habitat space much cleaner than most terrestrial interiors from the getgo. But that’s only the start.

Cooking odors, as much as we love them (save for chitterlings), can also become oppressive when there is no air exchange with the outdoors. Open boiling and frying may be verboten. Microwave and pressure cooker food preparation may be the way to go. If you’re on the ball, you just realized this means no more “backyard” or patio barbecues. Restaurants with autonomous closed loop air circulation systems may be permitted an exemption. The cost of such equipment will be reflected in the price of those ribs and steaks, however (as if the cost of importing such meats wouldn’t be pricey enough).

The “middoors” – fresh air faucet and stale air sink

Once we begin to construct settlements properly speaking, pressurized spaces will begin to sort out into relatively volume–restricted interiors of private quarters, offices, shops, etc. and the relatively volume–generous pressurized common spaces of streets, alleys, parks, and other commons, on to which the “indoor” spaces open. These pressurized all–interconnecting commons we have dubbed the “middoors”. There will be air–exchange between

“indoor” and “middoor” spaces, all within the continuous settlement mini-biosphere. That will be the source of some relief.

To make the middoors system work as both fresh air faucet and stale air sink, there will have to be a xity plan [“xity”, pronounced ksity, is an MMM-introduced word for an off-Earth (i.e. the x is for exo) community that has to provide its own biosphere, something no city on Earth has to do] that carefully arranges farming, residential, commercial, and industrial areas so as to create an air circulation loop cycling probably in that very order and back again. All mini-biospherians will essentially be living downwind and downstream of themselves, and this area zoning will provide the only limited buffering possible.

How do we do this and still allow for urban growth? The answer may lie in a cellular xity plan, in which each neighborhood has its own locally balanced area zoning and air quality restoring circulation. One happy result of such an integral neighborhood by integral neighborhood (or urbicell) plan is the millennia-overdue reintegration of city and farm, a restoration of the healthier pattern of farming villages. In the xity, as opposed to the city, vegetation will once again host humans, not humans hosting mere token house plants and landscaping accessorizers. (See the following article.)

In addition to the zoning pattern, there will have to be active ventilation and circulation assists in the form of fans. Air circulation need not be strong, nor steady except in an averaged sense. A certain randomizing of velocity and vector can simulate the pattern of natural breezes.

Part if this air circulation / freshness regeneration loop will be humidification in the agricultural areas, with fresh drinkable water coming from dehumidifiers elsewhere. Using water reserves in later stages of treatment for plant misting, water fountains, and waterfalls, will help control dusting and provide pleasant just-after-it-rains air freshness. Negative ion boosters can also be used here and there.

Fire and Smoke

As we learned from Skylab experiments in 1974, fires in orbiting spacecraft spread only one-tenth to one-half as fast as they do on Earth, provided there is no fan-assisted ventilation. On Earth, hot, thus lighter, combustion gases flow upward, and fresh, oxygen-rich air is pulled in to replace them, fueling the fire. In free fall space, there is no 'up', and no buoyancy effect. On the Moon, in still air, spread of fire by convection will be slowed, but still a factor, and fan-assisted ventilation is a certainty.

Far more important in all off Earth situations is the fact that we are dealing with sealed micro-environments. There is no fresh air reservoir “outdoors” and we cannot “open the window” to let out the smoke. While the flip side is that habitat fires will inevitably extinguish themselves through oxygen starvation, this will only occur long after they have resulted in very final casualties wiping out all unlucky enough to be present. In short fire cannot be tolerated, cannot be allowed to happen.

Fortunately, in lunar mini-biosphere environments, we will see extremely limited “gratuitous use” of combustible materials, other than for next-to-skin clothing. Furniture and furnishings as well as building materials will be all but exclusively inorganic and incombustible.

On Mars, that need not be the case, and so fire there could be a much more real danger. Possibly, through the Lunar experience, we will have become sufficiently weaned of the organic stuffs (wood, paper, plastics, foams, fabrics) so easy to provide in the macro-biosphere of Earth, that even though the volatiles-rich environment of Mars will support their reintroduction and our re-addiction, Martian pioneers may choose to forgo these temptations, living much as Lunans do.

Questions in search of answers

The Biosphere II experience gave us some answers to questions we didn't suspect existed, and even more importantly showed us the extent of our ignorance. There were problems maintaining the proper percentages of both oxygen (too little) and carbon dioxide (too much). We discovered some building materials (e.g. concrete) to be oxygen sinks.

Off planet, we don't even know yet what nitrogen oxygen ratio it will be safe to use. Nitrogen may need to be imported, and the less we can get by with the better.

We scarcely know how to build a biologically assisted closed loop air system, much less a principally biologically maintained loop. The Space Station (Mir or Alpha) rely on continual resupply shipments of fresh water and make-up air

A wakeup call

That will be no way to maintain a lunar outpost. Nor will it be a way to support a Mars mission — not on the planet, not even en route, going or returning! In plain fact, had we the money, we could not go. It's not transportation technology that will hold us up, but budgeting and policy failures to support the programs needed to develop closed loop life support systems. Meanwhile hardware jock space enthusiasts ignore the problem like so many ostriches. This attitude and our lack of involvement have to change!

We can't go if we can't breathe. It's as simple as that. Those who have survived near death experiences tell us that the most horrible way to die is not fire, as I would imagine, but drowning or suffocation – the absolute psychological panic of not being able to draw the next breath. Fresh air is not a luxury, nor just a good idea. We'd better be sure we know how to maintain it. **MMM**

Against the Overwhelming Barrenness of the Moonscape



A GREEN SECURITY BLANKET By Peter Kokh

Relevant Readings from Back Issues of MMM

MMM # 8 SEP '87, "Parkway"; "Animal Life"

MMM # 50 NOV '91, pp 8-9. "Trees"

MMM # 53 MAR '92, p 6 "Xititech III. Cellular Rhythm"

MMM # 54 APR '92, pp 5-6 "Xitiplans"

MMM # 76 JUN '94, p 1 "Windows, in with a new cliché"

Some of us are "house plant" nuts, some of us are hobby gardening enthusiasts. But perhaps most of us don't give vegetation, indoors or out, much thought. We don't have to. Given the general luxuriant feel of the outdoors, we get enough of a green-fix automatically without having to concern ourselves much about it. And that remains generally true, even in this era in which the health of the host environment is in question, and living nature under siege from selfishness, greed, and simple carelessness.

On the Moon life is not a given. There is none of that comforting green stuff maintaining itself on automatic. The outdoors is lifeless, barren, sterile – relentlessly so – assertively so – threateningly so. Greenery within the protected confines of the mini-biosphere will become a preoccupation of all but the most soulless personalities.

That a healthy abundance of plants contributes significantly and noticeably to air quality and freshness, will be a reinforcing motivation. (NASA-funded studies have shown that the right mix of houseplants can be quite effective in reducing household airborne pollutants.) But we suspect that for most Lunans, the real driver will be the need to use plant life as a security blanket, a psychological filter against the out-vac's life-quenching sterility, much as for smokers, a cigarette makes the world a friendlier place (no, I am not one).

If lunar homes and offices and schools have windows affording moonscape views, inside window box planters of houseplants will take the edge off the life-threat of that magnificent but deadly desolation. But we will find many other nooks and crannies to put plants. Greenery and foliage will become the mainstay of interior decoration. Everything else will play but a supporting role.

A much higher percentage of Lunans are likely to be home gardeners. They will be aggressive in finding opportunities to add plants. Quite possibly a solar-lit atrium space will become the organizing focus of choice in purchaser chosen home plans. Such a space will afford vegetable and herb gardens or a mini-orchard to help with the food budget and menu variety, maybe a tad of entrepreneurial canning. But it could also be devoted to purely decorative plantings of variegated foliage and flowering plants, song birds, hummingbirds, and butterflies. Or it could become a more mystical place, a Japanese style sand and stone garden. For despite the general preoccupation with plant life, there will still be a big range of personal sensitivities, and of lifestyle needs.

Architects in general will look for ways to build-in planters and other cubbyholes for plants, providing also for their illumination. Vegetation will be a new design parameter.

Out in the "middoors" too, every opportunity to tuck in vegetation will be aggressively pursued by architects and users. Middoor streets and passageways, intersections and squares, are likely to become as verdant as they are busy. This can be the concern of the xity administration, or, more healthfully, of rival neighborhood, and street merchant associations, or other stretch-"adopting" clubs.

While green will be the dominant color thus inserted into settlement life (architects and decorators will be motivated to find ways to introduce ambiently lit sky blue ceilings and open space sky blue vaults), settlers may rely on plant life to provide other colors as well. The early lunar art pallet (water-glass-based metal oxide "paints" and ceramics) will be one of generally subdued colors. As helpful as such additions will be, the thirst of the more vivid coloration of flowers (and perhaps birds and butterflies) will be strong.

It is likely that flowering plants will be staggered so that at least something is in bloom every sunth (the lunar dayspan/nightspan cycle). Will flowering plants grow taller on their own in sixthweight? Or can they be coaxed to grow taller? If so, Lunans may be able to savor the delight of floral "forests". These would provide a must-see tourist draw.

Trees are likely to be of the dwarf variety (many fruit-bearing dwarf hybrids are already marketed), more bush-like in size, at least until the cost of imported nitrogen makes economically feasible the construction of higher-vaulted middoor spaces. In the meantime, to fill the void, individuals and clubs may take strongly to the cultivation of bonsai trees, even to the point of growing bonsai forests, again a tourist must see.

The first parks may be interim floral and grassy meadow refuges within agricultural areas. Even if the farm units are highly mechanized assemblages of trays and racks and LED lighting arrays, the sight of so much greenery (and the freshness of the air) will make any kind of food-producing area a mecca for those living or working nearby.

In the previous article, we mentioned that mini-biospheres will guarantee the reintegration of city and farm, the overdue return to farm village roots and a more nature-harmonious lifestyle-paradigm. Already in this century here on Earth, most developed cities have thinned out greatly in density, giving much more space to greenery (even if still more to pavement, in homage to the great god Auto).

Also on Earth, we have seen a general increase in urban and especially suburban wildlife, a welcome turnaround, led by post-human species, species that have learned to thrive in human-dominated environments. We can hope that Lunans will indulge in the luxury (to bean counter eyes) of urban wildlife. We've mentioned birds and butterflies; surely bees, ducks, swans, flamingos, squirrels, even deer, and more.

In our cities, pockets of life are seen as a concession to nature. In the off planet xity, pockets of humanity will be the concession. Vegetation will play the host. The Xity will be an exercise in symbiosis, man and Gaia reunited. **MMM**

**[The following is an excerpt from a longer article about the Moon as a Froniter]
Frontier Biospherics 1.01**

If “gray engineering” has technical problems yet to be addressed, “green engineering” as it will be required on the off-planet frontier is in its earliest fetal stages. Most, amazingly not all, do appreciate that we cannot return to the Moon “to stay” without being prepared to aggressively phase in a mini- but functionally integral “biosphere” to reencradle ourselves on worlds without atmosphere, hydrosphere, and native flora and fauna. We may have long taken it for granted, but that does not alter the fact that we are quintessentially a symbiotic species. We must take our symbiotic partner with us as we move out into space. That partner is Earth-life in general, call it Gaia if you are not too hung up on the speculative excesses of the Margulis-Lovelock feedback theories. Sure we expect to be able to engineer an artificial symbiote: chemically regenerated air and water reserves, and foodstuffs à la Soylent Green. And need this approach we will, for cramped conditions on space stations and long-voyage spacecraft. After all, we have a long tradition of substitution of less than ideal life-support means aboard submarines, ships in general, and Arctic and Antarctic research stations. But long term, such measures can only support a caricature of human settlement.

Normalcy, such as a general population will find tolerable, will require “nature” in recognizable familiar terms to be involved. At first this involvement may be token, as with salad stuff cubicle farms, and CO2 scrubbing algal vats etc. But without the sure prospect and unquestionable commitment to a schedule of progress in the general direction of a self-maintaining diversified and balanced biosphere regenerating clean air and water, as well as producing ample food, fiber, and feedstocks of various utilities, frontier settlement will not be psychologically tolerable or self-maintaining in any sense.

Think of the ratio of water tonnage to biomass tonnage on Earth, and then of the ratio of biomass tonnage to the gross weight of the human population on Earth. Obviously, we have a tremendously long road to travel on the Moon or in other off-planet biosphere sites if these terrestrial ratios are the standards at which we ought to aim. Even with such high ratios, we are now seriously straining the recuperative capacities of our environment. How could we pretend to dream of not poisoning ourselves in very short order if, in off-planet mini-biosphere-wannabes the ratios of water:biomass:humans are only ridiculous tokens? Our mini-biospheres must be very extensive: not landscaped cities, but farming villages with farms. It is vegetation that must play host to man, not man to vegetation à la houseplants! Until this is the case, and it is a direction to move in, not something we can achieve at the outset, lunar settlements will still be “the frontier”.

Diversity of agricultural crops and complementary wild plant species, and a certain amount of post-human wild life as well (such as we find in our own urban and suburban and farming areas) will also be needed to provide a real biological flywheel as well as increasingly good mental health.

The following are but three sections of a very long article:

Spirituality

Effects of the Lunar Environment on Spirituality and on the Reinforcement of Personal Religious Sensitivities

By Peter Kokh

This article reflects the writer’s personal spirituality
and may be offensive or troubling to some.

This article is published in its entirety in
MMM Classic #10 which is a free download from



Absence of a given encrading global biosphere.

On Earth, “Nature” has a strong duality, the geophysical forces of the planet itself, and the biological forces of plant and animal life, and their ecosystems. Repeatedly, we see that the forces of the former operate with total inattention to those of the latter. Nature as geophysical force is responsible for all those manifestations that induce in us profound “awe”. Nature as life is more responsible for evoking the sense of “beauty”. The two together, a striking geological landscape setting clothed in life, instill a sense of awe and beauty together. This is how it has been for us from time immemorial living on this geologically active planet whose every niche, seemingly friendly or not, life has sooner or later found one way or another to colonize.

On the barren Moon, Mars, or elsewhere, it will be quite a different story. For future space frontier pioneers “Nature” will present herself as geology alone, not tempered by biology. Awe without beauty. Flora and fauna will exist only within manmade environments wherein its cycles will be controlled. The biota of mini-biospheres will come across as post-human “nature”, not pre-human “Nature”.

Apropos of our topic, in mini-biospheres, even in high domed or vaulted megastructures with an impressive achievement of varied biological diversity, one will not be as moved, on looking out the window of one’s residence, to be filled with awe and beauty and remark to himself “God has made a beautiful world”. Many may overlook the fact that these artificial biomes rely on genetic resources that we have found given to us in the Mother Biosphere, and feel less humble gratitude, more unwarranted human pride. We can hope that any such initial widespread reaction will in time be corrected and that respect, humility and gratitude will return.

Yet, precisely because of this artificialness factor, a conscious attempt at deliberate harmony may be deeper and stronger among space frontier settlers than it is among most of us. In mini-biospheres everywhere, people will live rather immediately “downwind and downstream of themselves”, with any environmental sins coming back to haunt them not generations later, but in very, very short order. On the space frontier, environmental consciousness is likely to be extraordinarily strong, both in depth and width.

Mother Earth and Father Sky

On Earth, the presence of Mother Nature has always been strong. In comparison, relatively few feel to the same degree the presence of Father Sky. It is an important and critical duality, and religious and spiritual traditions that do not speak to it, inevitably provide us with distorting filters through which to interpret the universe about us.

On the Moon, the tables will be turned somewhat, as this time, the surface of our adopted world with its barren and sterile expanses totally naked to the elements of cosmic weather, will clearly belong to the province of Father Sky, rather than Mother Nature who now will greet us only from within our minibiosphere oases. This major-minor shift in the melody of stimuli that impinge on our spiritual sensitivities will express itself inevitably and subtly in our literature, song, legend, myth, and other cultural expressions.

Man and Nature

The overall effect of the world’s various scriptures, whatever the sacred writers may have intended in each case, is to serve as an amplifier. Scriptures have always been used, and

always will be used to justify whatever one has done or is about to do anyway. This is said not in harsh judgment, but in honest observation.

Judeo-Christian scriptures, specifically Genesis, are often cited to justify a belief that Man is "lord and master" of creation. Nature is chattel, which like the chattel version of "wife," one is allowed to, expected to abuse into submission.

It is against this distortion that the more recent correction which holds we are stewards of nature, has had to struggle. In this paradigm, it is our humble responsibility and great privilege to preserve nature's balances and harmonies, and to pass them on in as integral a condition as we can, to the generation(s) that follow ours.

Sadly, many space enthusiasts who see space only from the viewpoint of hardware (if the only tool you have is a hammer, every problem appears to be a nail) are among those in the forefront of resistance to this new paradigm. But not only must we catch up here, we must move beyond.

Pioneers of the space frontier, living with biological ecosystems in minibiosphere oases, will come to see their relationship with nature as one of much more than stewardship. Our interdependent symbiotic bond with plant and animal species also pioneering the space frontier with us side by side will become fully apparent. We will have progressed beyond wife beating to paternal benevolence and then finally to a true partnership of mutual respect and support.

The other sub headings of this article are as follows:

- **The Human Condition** (The three sections above)
- **The significance of the frontier for the spirit**
- **Mysticism and reproductive responsibility**
- **We are not alone!**
- **The Cheshire Smile**
- **The social character of personal frontier vocations**
- **Working with the antisocial**
- **The Space Frontier and Monasticism**
- **Conclusion**

These additional articles can be found in their entirety in MMM Classic #10 at:
http://www.moonsociety.org/publications/mmm_classics/

The Moon will be a life setting unlike anything in the whole of previous human experience. The differences with Earth, in so far as they will impact personal spirituality and religious sensitivities are significant. For individuals and human society as a whole the spiritual repercussions of lunar settlement may be profound. PK

Greening the Gray

An Anthem for Lunan Pioneers

© Peter Kokh kokhMMM@aol.com

Previously published by the author in the July 1990 issue of Moon Miners' Review

We're bluing and gilding
brightly greening the gray,
against the siren black,
beneath the Milky Way,

Desolation, oh yes!
Yet how magnificent!

Here we'd settle and toil,
Our hopes not reticent,

We came prepared to stay,
Accepting the challenge,
To live off starkest land,
Dream ancient as Stonehenge,

We pride ourselves Lunans,
Our way of life Lunese,
Our uphill struggle gives
Rich meaning to life's lease,

We're bluing and gilding
brightly greenening the gray,
against the siren black,
beneath the Milky Way,

We've soil above our head
Just as below our feet,
Yet blind moles we are not,
Within, Sun's warmth we greet,

Safe against cosmic ray,
Sun's flare, meteorite,
Cool below dayspan's heat,
From nightspan's cold so tight,

Picture-windows' bleakness
Drains not spirit's ladle,
For within our shelters,
Greenery's our cradle,

We're bluing and gilding
brightly greenening the gray,
against the siren black,
beneath the Milky Way,

By old favor returned,
Now Earth shows time's reason
Calendar-in-the-Sky,
Marking year, date, season,

Ago we watched phases
of waxing, waning Moon,
Now lights of Earth cities
Inspire legend and tune,

Full Earth stirs our lovers
With its romantic light,
Sooth, as far as we reach,
We'll e'er hold dear this sight!

We're bluing and gilding
brightly greenening the gray,
against the siren black,
beneath the Milky Way,

'Neath the untempered Sun,
And naked sky's splendors,

We till the Moon's gray soil
For wealth it surrenders,

Against stark horizons
Of light highlands, dark plains,
We cook rock and bust 'lith,
Patiently earning gains,

The snail crawl of Sun-drench,
The slow drift of Star-awe,
Give freshening rhythm
To life, less season's law,

We're bluing and gilding
brightly greening the gray,
against the siren black,
beneath the Milky Way,

Turning to advantage,
alleged drawbacks galore,
Our gumption finds pay dirt
In this commonplace ore,

Nor lushly fertile soil,
Nor concentrated veins
Of minerals do bless,
No the key is our pains!

If we do yet succeed,
The trails we blaze will light
The way for the daring
Who'd follow into night,

We're bluing and gilding
brightly greening the gray,
against the siren black,
beneath the Milky Way,

Blest are we less endowed,
We must try harder,
And in the achievement,
We'll reach and soar higher,

Fresh opportunities!
Raw possibilities!
From these barrens we'll tease
Unsuspected glories,

Busy but slowfall-paced,
We'll bud free and grow tall.
Our children lithe and bright,
Life's preciousness is all,

We're bluing and gilding
brightly greening the gray,
against the siren black,
beneath the Milky Way,

From the songs of Firstnight
For clay-borns fresh landed,

To tunes befit life's end,
through lyrics we're banded,
We're farmers and miners,
Craftsmen and artists proud,
We're students and traders,
Creating, heads not bowed,
Our confidence in life,
In word and song foremost,
Cherish Old Lady Gray,
Our unforgiving host,
We're bluing and gilding
brightly greening the gray,
against the siren black,
beneath the Milky Way,
Dawn-test fraternity
of cradle foresakers,
We scout new paths for life,
Universe gate-makers,
Blest our dire wants and needs,
For they'll drive us far deep,
Into the night in search
Of rich sources to reap,
Resourceful bootstrappers,
We earn our keep as due,
Homage to TANSTAAFL!
To our selves we are true,
We're bluing and gilding
brightly greening the gray,
against the siren black,
beneath the Milky Way,
Moontides on blue depths sing
Destiny's overture,
Lever to black-set wealth,
Moon's role became mature,
In hollow spun islands
We'll furnish weight, less bars,
Where feet seek not Earth's core
But the high-circling stars,
We can, we must, we will
Undreamt destinies seek:
Finding ever new ways
For Earth-bred souls to peak,
We're bluing and gilding
brightly greening the gray,
against the siren black,
beneath the Milky Way,
Mother Gaia's first grads,
We are humbled yet proud,

Making camp here en route
Relentless to stars' crowd,

A new world we're shaping,
Not just for humans seed,
Earth flora, fauna too,
it's each other we need,

Frontierfolk of Luna,
Builders of space towns grand,
Wildcatters of comets,
Outfitters for Mar's land,

We're bluing and gilding
brightly greenening the gray,
against the siren black,
beneath the Milky Way,

True, our own wealth we seek,
But in process we'll give
Earth cheapest energy
The wherewithal to live,

The first of new rustics,
Many lessons we'll learn,
To teach old Earth in thanks,
For heritage in turn,

Hinterland pioneers,
Our destinies we seek,
In ways e'er true to roots,
Humble, but never meek,

We're bluing and gilding
brightly greenening the gray,
against the siren black,
beneath the Milky Way,

We came to find ourselves,
But also flee'ng limits,
Of stifling hordes and rules,
The pressures of habits,

The call of lands virgin
To humanity's effort,
Nor eco-thick with life,
Promise Freedom's comfort,

We left, looking not back;
Hoping here to increase
Yet for Old Mother Clay
We wish justice and peace,

We're bluing and gilding
brightly greenening the gray,
against the siren black,
beneath the Milky Way,

[END of the BEGINNING: To the author's knowledge, no one has set this "Anthem" to music.
Attempts to do so are encouraged.]



FOOTSTEPS ON THE MOON & OTHER LEAVINGS By Peter Kokh

Relics of the “Scouting Period” will be preserved as part of on site Lunar Frontier National Parks & Monuments or placed in Future Lunar Frontier Museums

One frequently hears complaints that we have already “trashed the Moon” referring to equipment and equipment packaging and other items left behind on the Moon by the Apollo explorers. The speaker silently assumes we will never return to establish a permanent presence on the Moon, that there can be no useful function of such leavings, that they serve only as pocks of litter. Since this set of assumptions is without justification, it does more to discredit those who parrot the chant than anyone else.

“One man’s trash is another man’s treasure” is an even more common tidbit of popular wisdom, however, and happily one that is definitely more applicable to the situation. “When”, not “if”, we someday return to the Moon “to stay” and make it “Earth’s Eight Continent” and the first of many human adopted home worlds, such items, from derelict space craft stages to scientific instruments to packaging waste to footprints – these will all suddenly become invaluable. They will be priceless “hope chest” contributions to future lunar frontier museums and monuments to the watershed epoch of early human and robotic exploration of the Moon..

Even if, to our great shame and discredit as a sapient race, we fail to use our talents and resources to expand into the human hinterland of Greater Earth as we have into all the other companion continents of our native Africa, the contention that these relics of exploration constitute “trash” exposes an indefensible view of man as something apart from, not part of nature. Rather we should have humble pride in these leavings. They are indeed venerable and admirable relics of great achievement and of the enormous capacities with which man has been endowed.

What we have left behind on the Moon is indeed “a promise”, a promise to return, to return and stay, a humble engagement token, a sign of betrothal. Even should this future hoped for mutually adoptive relationship with the Moon not develop, these things will still stand long after the rest of human civilization on Earth has crumbled into dust, as mute testimony to the glorious design of Homo Sapiens and the Creative Agency(ies) that led to our emergence, whether some scouting explorers of other separately arisen intelligent populations ever stumble upon them and feel the wonder, or not.

There has long been deep discussion of future political and economic regimes for the Moon, and on the question of property rights. However these thorny questions resolve themselves, and we have strong opinions on how they should) some very important, and arguably less controversial, legal questions are going unaddressed. Addressing them now could create a momentum of achievement that might help break the paralyzing logjam of endless debate over the other more disputed issues.

For example, we might now set up definitions, standards, and procedures for declaration of various sites and areas of the lunar surface as the lunar equivalent of national parks, national monuments, national scientific preserves etc. Procedures for nominating a site, for establishment of the special status, and for amending that status in the future are needed. At this date when evidence for a case of objection can not be maturely prepared (e.g. unique geochemical resources of critical economic value) candidate sites could remain simply

“nominees”. Protocols for the establishment of economic concessions that do not infringe on the scenic or geological rationales for the nomination, could be decided upon now, subject to revision as the on site learning experience unfolds. Might it not be unreasonable to expect that solving these “special” cases will help point the way to acceptable “general” solutions of the property question?

In addition to such special treatment of nominated areas of special scenic and/or geological interest, the historic sites of early lunar robotic and human exploration should be included. In each case, the immediate site could be handled as an easement, with use and encroachment restrictions passed on to whatever future jurisdiction or public, private, or commercial title as may come to be established.

These sites are just what we have labeled them, “hope chest” items for the future edification and education of lunar pioneers, settlers, and visitors to come. They need to be treated, individually and as a class, with honor, respect, and awe. Popular, if not universal contempt, should be approached as an opportunity for education and public outreach. When and where attitudes cannot be changed, we must sadly learn to dismiss them: “consider the source.”

These remarks are meant to address similar human/robotic “tracks and droppings” on Mars and elsewhere. These things will become the foundation of lore and legend. They will live on, their thoughtless denigrators passing from the scene into oblivion.

As human sites, the Apollo sites need special protection and handling. But even robotic sites are instances of virtual human presence and need attention too. It is not too early to discuss proposals for proper preservation and protection. Some of these sites will become enucleating centers of future human settlement. Others will affect the routing of future highways. Their places on the map are more than footnotes to be sure.

MMM

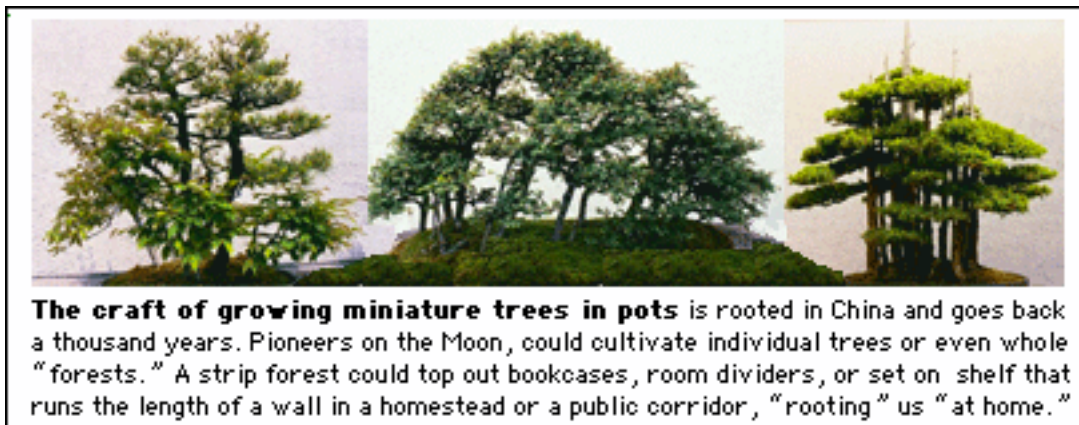

Even in smaller settlement and homestead spaces, Pioneers from Earth will want to bring their trees, and even forests with them, *bonsai* style!

Read “Trees on the Space Frontier” MMM #50 – November 1991, above



The sterile, airless Moon is already a depository of much cosmic information. Within some lavatube secure from cosmic weather, we can take a cue and create

The Grand Archives of Earth and Humanity

By Peter Kokh

Four billion years of geological archiving

Archiving, specifically and specially of the asteroidal and cometary debris bombardment of the lunar surface, and well as of the aeons of solar wind particle buffeting, have built into the magnificent desolation of the global moonscapes an eons-thick scientific archive of inestimable value. As such, the Moon has served, and still serves, as a natural probe of the near solar environment that our human-made robotic probes can only hope to dimly emulate.

The conditions on the fully exposed lunar surface, even more so within the partial shelter of permashade, and best in the yet-to-be-sampled full-sheltered environments within subsurface lunar lava tubes are such that deliberate archiving by humans of both cultural artifacts and vulnerable biological samples and specimens, are a suggested-in-heaven industry of considerable economic value for future Lunan settlements. Archiving will be one Lunan activity with all the marks of a 'vocation' or 'calling'.

Archiving on Earth is, and has always been, an activity fraught with danger, peril, and inevitable disaster. Remember the Library of Alexandria, and the art treasures of Florence lost in the flooding of the Arno, treasures and records destroyed in war, by earthquakes, mud slides, fires, and hurricanes, sadly, even by vandalism. The safest and most secure and environmentally stable environments on Earth can guarantee preservation of objects, artifacts, and records for relatively short times. Sooner or later, all human treasures preserved on Earth will be lost to the forces of human activity, weather, biological activity, and geological forces within Earth itself.

The sight lines of most of us are short. We pretend to worry about a slate-wiping asteroid that may hit us any time over the next few millions of years. Yet no Canadian or Scandinavian loses a night's sleep over the certain revisit of the great ice sheets within the much shorter timeframe of the next ten thousand years or so. Most of us care about what carries over to the next generation. After that — we're content to let the next generation worry about it. That is why the inexorable deterioration of the biosphere and of Earth's living ecosystems does not bother most of us. It is sufficiently slow relative to our own personal four score years of life expectancy. *Après moi, la deluge!* ("After me, the deluge.")

But there have always been those with a more eternal vision, from the scribes of ancient times to the Pharaohs to the medieval monks. The upshot is that much of human history has in fact been carefully preserved despite common indifference. Yet in the long run, what we add by archeological, philological, and historical research only adds to the amount of knowledge that will inevitably be irretrievably lost.

The first task facing would-be curators of the *Musea Humana*, is to find a depository site large enough and secure enough to preserve accumulated human intellectual, industrial, cultural, artistic, and similar wealth not just for a few generations, or even some centuries or millennia, but for veritable eons — yes, for billions of years!

Why! Certainly some for religious reasons based upon fundamentalist literary interpretation of this prophetic text or that, will be dogma-certain of the impending “end of the world” and see such an archiving task as complete folly and poppycock.

This essay is for the rest of us, not fortunate enough to be blessed with such private certitudes. For us, the reasons why are several. Transgenerational memory, without the prop of preserved reminders (museums and archives) are very short and quite inaccurate. Handing on knowledge of the present and past is one of the sure values we have to give the generations who follow us (along with a well-husbanded environment over which we exercise only temporary stewardship, a weightier burden than most feel or realize.) We need to preserve the record (as well as to add to it!) in a way that will keep it safe and inspirational and educational for generations to come. We have to think in “time capsule” mode.

Beyond the edification of far future descendants is the more mystical need felt by even fewer of us to preserve the human, and Gaian, record even beyond the possible death of humanity and Earth life as a whole. For whom? For others, maybe never, maybe just once or twice: we cannot know or estimate – of other origins, who happen by this way in their sojourning through whatever interstellar neighborhood the ruins of Old Earth find themselves at the time. It is a need, a sacred call, to give witness. For what we have achieved and done, at least the modicum of positive within the pile, will give eloquent testimony whatever Creative Agency(ies).that led to and fed our rise as an intelligent species.

The only place to do such archiving for the eternities is on the Moon, in (an) intact lava tube(s) that has(have) already survived inviolate for going on four billions of years — not millions, billions! Any passerby surveying our solar system, in whatever shape it may be in at the time, however distant in the future that visit may occur, cannot but come to the same conclusion. In all this System, lunar lavatubes are the most secure possible repository. (This is, of course prior to the Sun’s eventual aging and pre-death expansion into an inner planet melting red giant star before contracting into a white dwarf cinder some billions of years down the road.).

If you follow this line of reasoning, it should become clear that any visitors who have come our way in the distant prehuman past will have seen lunar lavatubes as the only site worth considering if they chose to leave behind some testimony of their passing (whether it be information about themselves or the more Cheshire Cat-like smile of leaving us a record of the Earth and its biosphere of that time, something of a depth and completeness and richness that we could never hope to reconstruct on our own. Thus Incomprehensibly enriching witness of a visit can be left without prejudice to the “Prime Directive” which may enjoy widespread if not cosmos-wide respect.

When we think of archives, we think of such inevitably trivial data such as genealogical records, and perhaps a more worthwhile mix of artistic and literary treasures encompassing the mediocre and degraded as well as the sublimely inspired. Government, institutional, bureaucratic and other historical records will be in the trove, to be sure – leaving to the future to find whatever is of value to those mining the hoard. Exhaustive samples of industrial creativity and scientific achievement must be included if the whole sample is to have unskewed worth.

Biological records will be a principal part of the whole. Intact preserved samples of every extant species will be priceless in a future in which many species will have become extinct. A geological picture of the ever-changing Earth and an astronomical survey of the solar neighborhood out to galactic depths will help future visitors pin down the epoch in which the archives were created, and the length of time during which they were maintained.

Archive science will spur much inventiveness as archivers strive to find and use ever better methods of preservation, display, and cataloging. As such, archiving will become a driver of progress of considerable value, creating for Lunans considerable intellectual property value.

At present, all industrial, historical, and art collections and records on Earth are at risk. In many cubic miles of available lunar lavatubes, immune to cosmic and geological events, with constant temperature, absolutely dry vacuum, total darkness and minimal background

radiation, we will find our single best bet to keep safe for others the record of what we have collectively achieved, as well as of what nature has left us to steward. Low-maintenance very long life presence/motion-activated solar electric lighting along archive aisles can be installed for use during surface dayspan. **MMM**

MMM # 108 September 1997



Plant-Only Diets

for Space Pioneers: The Good News

By Louise Rachel (Quigley), L.R.S. – Special to MMM

Stan Love's excellent short concept paper about the near-impossibility of having food animals in near-term space habitats [MMM # 107 JUL '97, p. 10.] cries out for reply. For he has clearly worked out by pure logic the necessity for astronauts to adopt "vegan" (plant-food only i.e. no eggs or dairy products, a stricter regime than the more common "vegetarian" or simply meat-free) diets without actually having any personal acquaintance with such diets himself.

We can survive on a Vegan Diet

If he were a vegan, or well acquainted with some, he would know that with only one tiny exception, 100% of human dietary needs can be easily filled by a plant-foods only diet, not 97% as he believes. The exception is vitamin B-12, which is produced by bacterial fermentation. Animal-product-eaters get some from the B-12 that ruminants have stored, while vegans use supplements derived from non-animal bacterial processes. Other than that, every nutrient needed by humans – including pregnant women, fetuses, and breast fed babies – is readily available from plants.

Complex carbohydrates (and associated fiber) are of course supplied in abundance by every whole grain, bean, pea, vegetable, and fruit you can imagine. Fruits and honey provide simple carbs, if you want them (bees may be needed in colonies to provide yield-increasing pollination).

Proteins and amino acids are present in whole grains, legumes, nuts, seeds, and many vegetables (especially dark green leafies, crucifers, and root vegetables); fruits are actually the only low-protein plant food. Each different plant provides a different mix of amino acids; it is now well established that anyone who satisfies caloric needs by eating a variety of different whole plant foods during the course of each day will get all the protein s/he needs. Combining different plant protein sources in a dish is not necessary as long as daily variety is assured and no amino acid will be lacking. The only potential catch is that whole grains have far more protein than refined flours – but astronauts and space colonists would not have leeway to waste the bran and germ by refining their flours anyway!

Fats and oils are of course also available from plants: corn oil, olive oil, safflower oil, wheat germ oil, nuts and seeds and their butters and oils, avocado, etc.

And all minerals and vitamins (except B-12) are present in plants as well; in fact, vegetables and fruits are the primary sources of most of them. Iron is plentiful not only in meats but also in dark green leafy vegetables and many legumes. Calcium, usually associated with dairy, is available to humans from the same place the cow got it: whole grains and leafy greens. And if you're not eating animal foods, you absorb and retain dietary calcium so much better than if you're carnivorous that you will not need nearly as much. Short-term astronauts can take B-12 supplements with them. Long-duration space colonies will have no trouble making B-12 for themselves: the necessary bacteria take up very little space, and using them is an off-the-shelf technology.

In short, all dietary needs for human health can easily be met by growing a well-chosen variety of plants as part of the space habitat life support system. Animal foods are utterly unnecessary.

A Vegan Diet can be satisfying

The real question for astronauts and space colonists therefore will not be “can we survive on a vegan diet?” but rather, “will such a life be worth living?” It will be hard for some to believe that the answer is and unqualified YES.

Here, let me digress into personal history. In early 1990, when I was an omnivore (eating both plant and animal foods), I met and married a vegan. Within a few months, my 11-year old announced she would never eat anything with a face again. So although I had never formally renounced meat myself, I found myself cooking for and eating with vegetarians, and with most meals vegan, on a permanent basis.

Several results surprised me. First, when my meat-eating dropped below once a week, I started losing my taste for meat: I would order meat in a restaurant and not enjoy it in the way I remembered. After a while, I stopped ordering it. Second, I didn't miss it. By then, I had discovered the many worlds of vegan cuisine: traditional Chinese, Indian, Mexican, Middle Eastern, and many other traditional peasant foods from all over the Earth to provide inexhaustible variety of dishes and seasonings.

You can eat vegan forever and not get bored, especially since many of the tastes we associate with a given meat food derives in fact from the spices and not the meats: the taste of tomato sauce comes not from the shipmate but from the oregano and basil, for example, and rosemary-roasted potatoes give you the same pleasure as rosemary-roasted lamb.

Third, I discovered only after I had eaten this way for a while that I did not get weak and puny when I ate plant foods only, and gave up trying to balance proteins in each meal. On the contrary, in fact, I get fewer colds and have a lot more energy, and since I've gotten more physically active over the last seven years, I've gotten more muscular and vigorous on the vegetarian diet than I ever was as a carnivore.

I don't think average Americans can believe that eating any reasonable variety of whole plant foods, without paying attention to their different amino acids, really can give a person what one needs, unless and until one makes the experiment. It did take me a while to work my way into this regimen and get comfortable with it, but the proof lies in my and my husband's continuing health – he's been eating this way since '82. Proteins are adequately supplied by plants, and without doing a “balancing act”.

Enter meat-substitutes

The other good news is in a sense more recent. After all, some humans have eaten a vegan diet out of necessity or conviction (spiritual or other) for thousands of years. But foods specifically intended as meat substitutes are extremely new arrivals on the food scene, and have been developed only in the last few years as more and more individuals began experimenting with giving up meat for reasons of health or kindness to animals or environmental concern or social justice. Many of these people have chosen not to actually eat animals, yet they did not want to lose the pleasure they associated with animal foods. As a result, a whole meat substitute industry is now also an off-the-shelf technology, and has matured rapidly to the point where some of it is awfully good.

Taste and experimentation do certainly play a part: I myself have not yet found a non-meat hot dog that I like, for example, though I adore a couple of different soy-product burgers. But many substitute meats are absolutely delicious in themselves, and many are difficult or impossible to tell from the real thing. [Most of us, I dare say, have eaten soy-product bacon bits, on salads, baked potatoes, etc., with satisfaction for years. — Ed.] Granted that the best results are so far found in dishes such as sloppy joes, spaghetti sauce, marinated kabobs, and so on rather than as fake steaks.

The existence of these products means that space colonists will even have meat-substitute choices that are thoroughly palatable and hard to tell from the real meats they have

left behind. Some will probably eventually abandon the meat substitutes, while others will depend on them. Both these camps will enjoy their meals.

Stan Love concludes that astronauts (and early space colonists) “will be largely vegetarian, in spite of any personal preferences.” That sounds dire, and it doesn’t have to be. They surely will probably be vegetarian – vegan, in fact. Yet they will be as well and happily and deliciously and healthily and variously fed as any humans on Earth. <LRQ>

Editor’s Postscripts

(1) “Cultured meats”

One of the things that has long seemed possible to me is a (moral, if you will) compromise, in which we learn to cultivate real animal tissues (chicken breast, beef liver, beef, pork, etc.) in nutrient-fed vats. The result would be real meat without the animal, “without the face”, except that of the ancestral donor. How satisfying this would be, or how economical from a food-production point of view, I do not know. But it offers a third choice for those who realize the high costs of meat production but do not want to give up their meat.

Biosphere II required seven acres to provide a sparse vegan diet for a handful of people. A space biosphere that insisted on supplying meat, even from the more efficient sources as chicken, rabbit, cavy (guinea pig, a Peruvian meat staple) and fish would need to be many times more spacious. We may want meat, but it will be a definite and pricey luxury.

(2) 125 ISDC ‘98 attendees try it

Louise Rachel Quigley & Hyatt Regency Milwaukee Chefs put together a space frontier vegetarian luncheon for Saturday noon with Al Binder speaking. It was a hit!
MMM

MMM # 109 October 1997

Luna City Streets

[This is a lengthy article about all the aspects and functions that a settlement street may have and play. Here, we reprint just two sections.]

LUNA CITY STREETS By Peter Kokh

Street Vegetation and Forestry

Purely decorative flowers, plants, shrubs and trees producing neither food nor fiber, herb or spice, dye stuff or pharmaceutical, will be hard to justify. An exception might be a memorial floral gardens partially fertilized with the ashes of departed pioneers. Such a special spot is bound to become a favorite backdrop for wedding photos etc. Some small luxuries are simply worth the cost.

Fortunately, some environmentally conscious landscapers are having great success on Earth making decorative and ornamental use of food-bearing plants and trees. Pioneers may enjoy no oaks or elms, pines birch, or cypress – but there will be orchard trees like apple, pear, cherry, orange, banana and the like, and fiber-producing trees like Kapok. Others have suggested bamboo, useful for making informal furniture, scaffolding, etc.

Personally, while I can see a great role for bamboo on nitrogen and carbon rich Mars, the idea of permanent withdrawals from the costly, volatile-limited lunar biospheres seems an obscene luxury. Perhaps it can be allowed if accompanied by a discouragingly high luxury tax, high enough to pay for the replacement volatiles involved. Along the same line, wood may be so precious on the Moon as to make it a favorite jewelry stuff. Hard cherry and apple would be natural for such uses.

The major determinant, however, will be the design climate of the street-grid biosphere. If semitropical, i.e. never freezing, we'll see a completely different list of food bearing plants than if it is designed to freeze seasonally, in temperate fashion.

Possibly various neighborhoods could be designed diversely in this respect so that the city as a whole enjoys a greater variety. It is the more likely that climate will be a citywide choice, however, and that some towns will be temperate, others subtropical, others tropical, etc. Variety at the produce market will then come from vigorous inter-town trade. Such differences in town climates will also generate healthy inter-settlement tourism, making possible welcome changes of scenery.

Many fruit and vegetable plants produce blossoms prior to fruiting, and such blossoms can take the place of purely ornamental blooms in adding seasonal dashes of color and beauty. Simple juxtaposition of useful plants of various heights, shapes, and shades of green will be pleasantly decorative enough as a free plus.

As to trees, we will see a definite change in maximum allowable height as the settlements grow and mature. The first "pocket forests" may actually appear in early outposts - caricature groves of "pet" bonsai trees. There will be room for little more.

Next will come dwarf orchard tree varieties which can be planted even in in-home atrium garden solaria. But as street cylinders of ample radius are built, we will have room for much taller fruit and fiber trees, even bamboo grasses.

Urban Street Wildlife

A biosphere without wildlife might be more efficient. But it would fail utterly to teach and remind young settlers of the host planet, teeming with wildlife, into whose midst the human species emerged. It will be both more educational and more moral-boostingly healthy to have some wildlife, however sparse and token.

The worthiest niche will be for pollinators. On Earth, these include honey bees, hummingbirds, some butterflies, and some bats. Their presence will give delight to many, as well as teach how real ecosystems work. Where plantings are in soil rendered from carefully aged regolith with the assistance of microorganisms, earthworms will introduce yet another phylum, yet another example of life's tremendous capacity for diversity.

A small captive flock of slow-breeding flamingos might quickly establish itself as the popular town mascots without devouring too much recyclable biomass. Certainly such animal mascots would cost the settlement orders of magnitude less than would any human mascots of some monarchy!

If there are open water canals making use of reserve water in process of treatment for recreational use, these can be stocked with both game and decorative fish (e.g. trout and poi). A large aquarium would serve even better to teach and remind youngsters how life began, in the oceans. We hope to speculate more on such options in another article. **MMM**
[The entire article is printed in MMM Classic #11]

MMM # 110 - NOVEMBER 1997

["Xity": a city that must establish and maintain its own mini-biosphere]

"Reclamation" is a Xity's Charter Function

By Peter Kokh

Historical Precursors of Reclamation

There are precursors of reclamation, at least of the con-creation of a settlement's own eco-niche, scattered throughout human history. In many areas throughout the world and throughout history, areas at first unpromising as settlement sites have been transformed by hardworking pioneers into what are now some of the richest, most fertile lands on Earth.

[As we have remarked before, this is an instance of the unsung Beatitude: “Blessed are the Second Best”, i.e. those unable to compete where life is easy, forced to move to less promising outbacks, left to fall back on their own resourcefulness and to make do with less.”]

River-hugging farming villages have succeeded in greatly expanded their productive farmlands by reclaiming adjacent expanses of desert through irrigation. Similar villages on narrow plateaus or in narrow valleys have done the same by learning to terrace the surrounding mountain slopes, thus reclaiming them from barren non-productivity.

In the Netherlands, the Dutch have learned to build dikes to tame the tides, then to drain the backwaters and establish fertile non-saline farmlands, called polders*. And so they have reclaimed relatively worthless sea bottom and tidal flats. The dike is the analog of the pressure hull, the polder of the modular (or, someday, monolithic) hullplex that contains the settlement’s biosphere. For the Dutch, this ongoing annexation of turf, formerly surf, has continued for centuries. To live is to grow is to keep reclaiming ever more wasteland and transforming it.

The great dike that created the fresh water Zuider Zee from the once saline IJsselmer, a bay of the North Sea, is like a giant sun-shading ramada, in that it creates lee space within whose shelter, reclamation can proceed at an even faster pace. The peat mined from the freshly reclaimed sea bottom lands prefigures the solar wind gases to be scavenged from the lunar regolith during site preparation, building materials processing and construction.

Nor do the Dutch toil just to increase their annexed farmlands, they toil to maintain them, even as space pioneers will have to do. Maintenance and growth have to proceed hand in hand. Eco-niche lands won from the sea bottoms, whether of oceans or of space, must be defended ever after. Life always strives against entropy. Rest is fatal. Reclamation is the life of the desert oasis, of the mountain-terrace farming villages, of surface settlements on worlds not blessed with oxygen-sweet atmospheres.

Because of this “charter burden” these precursor settlements on Earth might aptly be called “xities” (in so far as they are at least biosphere-challenged in comparison to other, at first glance, more propitiously sited towns). And that should give us all comfort and encouragement, we who would establish “xities” beyond Earth’s biosphere altogether, not just beyond its more fertile reaches. There is precedent. We have spiritual ancestors. Their success gives us models to follow. We are not alone. What we would do emerges as a natural extension of what the best of men have tried and succeeded in doing before us.

It is the Epic of Life, in which the hero thread continues to be carried by the Second Blessed. We who find ourselves stifled and hamstrung on Earth where life is easy, it is we who hear the call to pioneer where life must be unimaginably harder, where left to our own resourcefulness, we have a chance of living a life more satisfying than any we could hope to live here in any of the genteel soft-edged Baltimores of Old Earth.

Space pioneers will learn to reclaim the sea bottoms of space, i.e. the vacuum-washed surfaces of barren worlds like the Moon, annexing areas bit by bit into growing pressurized modular mazes. Herein they will not have simply enhanced a local portion of a given common biosphere, but created a biosphere from scratch, where not even the seeds of one existed beforehand. As the settlement grows, as more and more of the space sea washed surface is incorporated into it, won from the sterile vacuum and turned into verdant farms and luxuriantly green villages, the infant biosphere will grow in mass, in reserves, in diversity, in resiliency, and in the satisfactions of life it affords its toiling inhabitants.

Reclamation is the xity’s “job,”

And the xity will thrive as long as it continues to pursue this goal.

Under the aegis of “reclamation” will fall all the major manpower using tasks of the Xity, at least in an oversight capacity: new expansive construction, using export production byproducts for that purpose, pressurization maintenance and repairs, air and water recycling and refreshing, and the food cycle that is part and parcel of those two tasks. It is the indivisibility of its biosphere that gives the xity a charter monopoly on these reclamation tasks.

Reclamation is appropriate in all parts of the Solar System beyond Earth's sweet atmosphere, in free space itself, on Mars and among the asteroids, on Europa and Titan, and wherever human resourcefulness will find a way to establish viable biospheres in which we can live and grow.

Perhaps many a reader has found the name of our society esoteric: The Lunar Reclamation Society. But if "Communities Beyond Earth" are our common goal, then it should now be clear that LRS is right on target in defining the challenges.

<MMM / LRS>

MMM # 116 July 1998

a **MODULAR** Approach to **B I O S P H E R I C S**

Designing every Occupation Unit as an EcoCell

A MODULAR APPROACH TO BIOSPHERICS By Peter Kokh

Moving off planet (Earth) is much more than a matter of engineering cheap transportation to space. It means moving out of the Biosphere that envelopes and involves Earth's global surface layers (air, the land, soil, water) and everything in them. It means moving to an area, whether in free space or on the surface of other bodies in the solar system, where we must create biospheres from scratch to live within.

Even the problem of "designing" "stable" minibiospheres seems quite daunting, discouragingly replete with too many parameters to be taken into consideration. The globally followed Biosphere II experiments in Oracle, Arizona were widely reported and still believed to be a failure. Such an attitude angers us and fills us with contempt at those who report or parrot such conclusions. First, nothing is a failure from which lessons are learned. Second, there is no other path to success than a pyramid of so-called "failures".

But what we did learn from Biosphere II is that finding a successful "equation" is much more challenging a problem than we had hoped it would be. We suggest that that is because we are going at the problem from the top, looking for a centralized solution or equation, rather than from the bottom. In nature, everything works from the bottom up. This means, of course, laying foundations, a step many people hope to avoid, in their impatience for results, in whatever endeavor they embark upon.

That looking for a central topdown equation for a stable self-maintaining biosphere should be an effort doomed to failure, should be self evident. If a solution were to be found, it could only be a "point" solution, a point in time at which just so many factors were in play: x number of species x', y number of species y', z numbers of species z' - and on and on for all the plant and animal and microbial species involves - and for the number of the human population included - and for the land area and air volumes of the biosphere etc. Now what good is a static solution for elements that can never be in stasis but always jockeying for position, as living ecosystems do?

That biospheres cannot be successfully designed from the top down should be no more surprising than that economies cannot be so designed, much to the chagrin of those who persist in trying. Nature, it seems, is as democratic as economics. Perhaps, we should start from the bottom.

HUMAN OCCUPATION UNITS - THE SPECIAL CASE

In Einstein's theory of relativity, the "special case" was much easier to formulate than the "general theory", preceding it in publication by some nine years, I believe. Similarly, we are here taking a look at one element in the biosphere, but an all-important one, human occupation

units. Because these will ever be growing in number, and the volume and mass of the biosphere with it, and because they create the greatest stress on any would-be “equilibrium”, the problem occupation units pose is a paramount one. Coming up with an approach that greatly aids towards a “general theory of modular biospherics” would be an important first step.

By **Occupation Unit**, we mean any structure that houses sustained or intermittent human activity of any type that requires a toilet. – living units (homes, apartments, hotel units), places of work (factories, laboratories, offices, schools, stores and shops, etc.), and places of play (theaters, parks, playgrounds, sports facilities, etc.). Why is this important? Because the toilet is the point-source of one very significant demand on the biosphere’s ability to recycle and sustain itself. If, as on Earth, we ignore the problem at the source, and shove it off on central water purification facilities, we make the problem and challenge of biospheric stability and self-maintenance enormously more difficult. If, on the other hand, we tackle this problem at the source, in every occupation unit in which there is a toilet, then the aggregate problem needing to be addressed on a centralized or regional basis is greatly reduced.

THE INDOOR GRAYWATER SYSTEM

Several months ago, while convalescing with my shattered leg, I was watching one of our PBS channels on a Sunday afternoon and happened to take in an episode of “New Garden” that told about the unique “Indoor Graywater System” of retired NASA environmental engineer, Bill Wolverton. In the 70s, while working for a NASA that expected to put colonies on the Moon and Mars, Wolverton came up with a system that treats 95% of the problem of human wastes at the source, i.e. within each home or occupation unit. Each toilet feeds a long row of planters that accept the waste as nourishment, and in payment, not only remove 95% of the “pollutants” before the residue water exits to the exterior, but renews and freshens the indoor air, and provides an ambiance of luxuriant greenery. The planter sections adjacent to the toilet are planted with swamp varieties, then come marsh plants, bog plants, finally regular soil plants. The plants are content with low light levels – much less than full sunlight.

Wolverton’s system has been operating in his Houston home successfully with no problems for over twenty years. While he invented this to meet then projected NASA needs on a since abandoned space frontier, he continues to work on adapting it to terrestrial needs. For examples, his planter “soil” is extended with “popped” clay pellets that are light weight so that his systems could be used throughout high rise buildings, providing fresh air, the ambiance of greenery, and precleaning the waste water, without adding undue weight loads, floor by floor.

Wolverton’s system runs along the periphery of his home, to make use of ambient direct and indirect sunlight through rows of windows. Artificial light could be used. How could this translate to lunar and Martian or other extraterrestrial applications?

In the case of surface-burrowed settlements, sunlight can easily be brought in by heliostats or fiber optics, making use of coatings to leave most of the heat outdoors. We have written about such possibilities on several occasions. A modular lunar home, office, lab, shop, or whatever, using filtered dayspan sunlight, and artificial light intermittently through the two week long nightspans, could be combined with Wolverton’s indoor graywater system to produce a home or occupation unit in which it would be a delight to live, work, or play: full of sunshine, greenery, fresh air – the perfect counterpoint to the alien, barren, sterile, hostile environment out on the surface itself.

In lunar or Martian lavatubes, artificial light, of wavelengths close to that of sunlight, would have to be substituted. On Mars, where sunlight is only half the intensity of that available on the Moon or on Earth, less filtering would be needed for surface-burrowed installations.

What such a system gets us, applied without exception across the board, is considerable. Each occupation unit becomes in effect a functioning cell of the minibiosphere, something much more than an inorganic construct of building materials. Each home or working unit now becomes an organic system as well as an inorganic one (of pressure hull with electricity, temperature controls, and plumbing). In such a system, we begin to look on the home or occupation unit in a whole new light, not as a foreign intruder in the biosphere that imposes an uncompensated burden, but as a place to live and work that is itself an integral

functioning part of the biosphere. The indoor graywater system not only greatly reduces the environmental impact of each occupation unit, it contributes biomass and helps recycle the air, as well as the water, locally. The home or occupation unit thus becomes a responsible citizen of the minibiosphere. Further, the effect of such a system is to make all homes and occupation units much more delightful places to live – an incalculable plus on the space frontier where so much that mentally and psychologically sustains us on Earth – where we take nature and the biosphere for granted – has to be given up. Here is a living unit with a mission, a mission that works.

As we advertised, this is a “special case” start towards a whole new “modular” approach to biospherics, and approach in which we try to minimize the environmental impact of each element, natural or post-human, by addressing it at the source. This minimizes the residual problems that require regional or central solutions.

The modular approach to biospherics makes sense, because it lends itself to human communities, and their coupled minibiospheres, that can and will grow, naturally, as their economies warrant, addition by addition. Centralized biosphere planning may be narcotically attractive to those who would mega-plan topdown large fixed size settlements such as O’Neill colonies or all-under-one-dome surface cities. But such places, at first underpopulated, briefly populated just right, and then forever after overpopulated are fairy tale dream puffs that cannot deliver the idyllic livable picture postcard environments that artist illustrators have many accepting as the goal.

Modular biospherics is not only a better approach, it is the only approach that can work. Designing frontier habita and activity units as living EcoCells is a big down payment in the right direction.

<MMM>

Order “Show # 707 Indoor Graywater System” from New Garden, New Braunfels, TX \$24.95

MMM # 131 December 1999

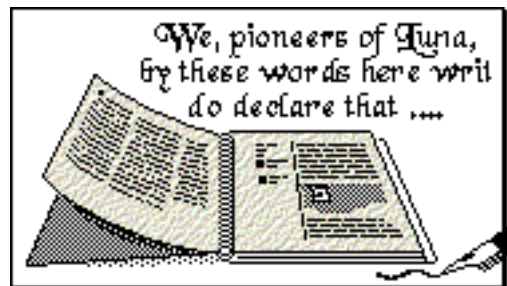

The Settlement as an Intentional Community

By Peter Kokh kokhmmm@aol.com

We know the origins of some of Earth’s cities and towns. For most others, their origins are lost in the myths of time. Yet with few exceptions (planned capital cities like Washington, Brasilia, Islamabad, Canberra, etc.) cities have grown haphazardly, with no force shaping them other than topography (coasts and rivers, mountains, etc.) and the fortuitous conjunction of economic forces and fortunes.

Of “Xities” and “Reclamation”

In our series on extraterrestrial settlements MMM’s #s 52–60, we coined a new word for communities that do not arise in a preexisting global biospheres, but which have to provide, and maintain, mini-biospheres of their own, with no forgiving “sinks” to act as buffers for environmental irresponsibilities. The word we offered was “Xity”, “X” standing for “exo”, of course, but pronounced hard: **KSIH tee**, not ek sih tee. We want the word pronounced in two syllables, like city, not three. The hard sound is a clue to the task, difficult beyond precedent, that any/all settlements beyond Earth’s cradling and coddling planet-wide biosphere must face.

Dutch towns below sea level come closest as a model. Their protective dikes holding back the tides and surges of the sea must be religiously maintained. The dike is an analog of the seamless pressure hulls of space settlements (modular or megastructure). The pressure hulls in effect “reclaim” from the seas of space, vacuum, and cosmic radiation, formerly “inundated lands” that are now made fertile, capable of supporting life. As we’ve said before, “reclamation” is job one for any space frontier settlement, a job that never ends. With eternal maintenance and vigilance, the reclaimed area hopefully will increase in size, fertility, productivity, and population.

Education Responsibilities in Fragile Biospheres

This “defining” “task one”, means that the settlement cannot take a laissez faire attitude about the environmental education of its citizens, when it comes to awareness of their shared vulnerability and the responsibilities that each must assume as his or her own. The critical difference between the global biosphere that terrestrial cities take for granted, and the local mini-biospheres that space frontier settlement cannot ever take for granted, is that the latter have no massive “sinks” to buffer the effects of environmental sins and episodes of carelessness. On Earth, we mess up and it affects our grandchildren. Out there, we mess up and it’s all over. The pioneers will live immediately downwind and downstream from themselves. Everyone, not just some, must care.

Whatever other educational freedoms are guaranteed, all citizens must know, and understand, how their biospheres work: how the air is kept fresh and recycled, how the water is kept free of pollutants and recycled, how vegetation is to be cherished and cultivated, and more. A part of this common education will be to provide a menu of chores suitable for children, with some degree of rotation, so that everyone has basic familiarity with all the biosphere’s systems. And when they come of age, a year or two of universal service running the air and water plants and the agriculture areas would instill an even deeper sense of “ownership” and better citizenship.

And that is what each settlement must seek to instill: a sense of ownership of the systems and the fragile balances that make community life possible beyond Earth. The test of this appreciation is the degree to which it appropriately affects individual microeconomic decisions as well as environment-relevant housekeeping habits, public and domestic.

Economic Health of Citizens

Space frontier towns will be hard pressed to survive unless a much higher fraction of their populations are productive than seems acceptable on Earth. Health priorities must be turned around with emphasis on expectant mothers, infants, children, and seniors with good years left in them. It will not work to take a hands off attitude on prevention and then plow inappropriate resources into remediation.

For economic productivity, the same is true. Every effort must be made to equip every citizen with all the tools and knowledge each can use to become as productive and creative as their individual talents and aptitudes will allow. Being relaxed about education and then having to plow major resources into welfare, etc. will not work. The settlement cannot thrive unless each citizen is offered the best individually tailored education, not just a basic one.

The University system especially must be geared to work with would-be entrepreneurs in development of new products for domestic consumption and/or the export trade, to maximize the economic self-sufficiency of the settlement.

Just “retiring” seniors will make no sense. Putting them to work on new tasks such as educating the young and taking care of much of the administrative load will prolong their usefulness and self-satisfaction, while relieving those in the prime of life for tasks related to production and trade.

Conclusion

On the space frontier, many things we have always taken for granted on Earth, must become the object of concerted “Intentional” Communal Effort. The upshot is **a linkage of**

citizen rights, on the one hand, and of **duties and responsibilities** on the other. The former must be guaranteed, the latter must be mandated, by the Settlement charter. MMM

Vision without action is just a dream

Action without vision is just activity

Vision and Action together can Change the world.

“Spinning-up” Frontier Enterprises Profitable for both Earth & Space

In Focus Editorial by Peter Kokh

The outlook for Space Enterprise would seem to be grim in the wake of the Motorola Iridium bankruptcy. We beg to differ. Yes, investors will be wary of big space enterprise proposals after this major collapse. But how, in truth, would the success of Motorola's effort or of any similar effort help open the space frontier? It would have helped build the market for small payload launchers. Our point is that small satellites and small payload launchers, while they may make money for individuals who may also happen to be interested in opening space as a human frontier, do not in any direct way remove any of the considerable hurdles confronting those who would open space to human beings on any truly non-vicarious, non-virtual level. Small payload CATS, certainly good in itself, is probably not much more than an energy-sucking detour.

We need cheap access to the threshold of space, LEO, for large payloads and for people. AND we need cheap, fast transit “in” space itself. AND, once we can get cheaply and quickly to places where we can tap the vast resources of space, we need the industrial tools to do so. Alas, no one seems to be working on any of this home(planet)work backlog.

The “rocket science” portion of this agenda, we must leave to those with expertise in those areas. What we'd like to talk about is the vast, unexplored potential for making real money now, developing processes and industries to meet the common unexplored resource challenges of good old terra firma Earth and of sundry worlds in space alike.

The considerable “bricks & mortar” portion of Earth's economy, which will never disappear or become irrelevant, has been built entirely upon the tapping of “enriched” resources. It is obvious that it will be cheaper to mine rich veins of ore than more homogenized concentrations of the elements vital to industry. It is obvious, too, that if we are to have self-reliant settlements on space, that they must also be able to “produce” economically, the elements needed for their own industries. The hitch is, that concentrated ore bodies are a terrestrial asset which we are unlikely to find elsewhere in the solar system. No where else has there been billions of year of geological processing of a world's crust and mantle in the presence of water. Not even on Mars, where such processing may have started only to be nipped in the bud much too early.

Poor Ore Mining Technologies

For accessing necessary resources on the Moon, on Mars, and even on the asteroids (where there is an unsubstantiated widely held belief that concentrated ores may indeed be found), we need to develop mining, beneficiation, and processing technologies that are economical in unenriched deposits. Talk to a mining engineer, and it is likely that if you bring up the subject of “mining the Moon” or Mars, you will be greeted with a contemptuous, condescending put down. No one knows with confidence, how to “produce” metals or other elements from such “poor” ores economically on industrial production scales. To point to lab-verified pathways of getting oxygen, for example, is not helpful or useful.

We will see no self-reliant resource-using lunar or Martian settlements until we have such technologies. Give us CATS and we will still have nothing! Nor would a political turnaround of unrealistic proportions that would make a lunar or Martian “outpost” a confirmed agenda

item change this situation. “Local Industry” beyond a few relatively easy and simple symbolic things, will not be necessary for the token outposts such a political miracle might put on the agenda. We must not assume that if NASA (i.e. Congress) did indeed reverse itself, it would undertake crash programs to develop such technologies.

There is another way, a very mundane way to get the job done. Sadly, space-enthusiasts in general are too much too impatient to sidetrack their efforts to indirect methods that may in fact be much more powerful. These very same “Poor Ore Mining Technologies” would be very useful on Earth, whether we ever do go on to open up the space frontier or not.

Consider Earth’s economic geography. The distribution of iron ore, copper, bauxite (aluminum), uranium, and other elements vital to industry has largely predetermined which nations have thrived and which have not. Of course, other factors play vital roles: arable fertile soil, access to the sea, forests, and the enterprise quotient of the people.

Poor Ore Mining Technologies would usher a substantial equalizing force into the world economy. Soils everywhere contain abundant aluminum and iron, but not necessarily in the concentrations and in the mineral forms we “know how to” work with cost-effectively. Chemical engineers must blaze new pathways that balance favorably energy inputs, secondary marketable byproducts, and environmental impacts. Concrete specific proposals tailored to the mineralogical circumstances of the various candidate locations need to be made to local or non-local investors and partners that stand to profit. Some of these poor ore mining technologies may have direct or indirect application to the situation we will find on the Moon or Mars or elsewhere. But even where this is not the case, we will be building up a pool of people with a “can do” attitude to supplant the present unhelpful crowd of “can’t do” mining experts.

Molecular technologies under exploration by people like Steve Gillette of the Univ. of Nevada-Reno offer some real revolutionary promise of an end run around present mineral-cracking hurdles. When it comes to producing strategic elements that are much less abundant, like copper, zinc, silver, platinum, gold, etc. where a 1% ore is considered rich, bio-extraction technologies need to be pushed. Without concentrated ore bodies, such elements are often present in only parts per million [ppm], or even parts per billion [ppb]. Bioengineered bacterial cultures may be able to greatly beneficiate or enrich these ambient concentrations. Here on Earth, such technologies would make many nations less dependent on others, less subject to political blackmail.

Novel Building Materials

On the Moon, there are neither forests to supply us with wood, nor petroleum reserves to supply us with chemical feedstocks for the host of synthetic materials to which we are addicted. Even on Mars, with a carbon and nitrogen rich atmosphere and plenty of hydrogen at least in polar ice, bringing such traditional building materials and manufacturing stuffs on line will be a trick. But is the situation any different for scores of countries on Earth that do not have appreciable forests, or who cannot afford to make further inroads into those they still have, and without native oil reserves?

Glass-glass composites have been proposed, and lab-researched, as a promising option for lunar settlement industry. But if we learned to produce a versatile array of glass composite building products and manufacturing stuffs, that could be an immense aid to the economies of countries that must presently import vast quantities of lumber and other products. There would seem to be ample economic incentive for taking this exotic stuff out of the labs, make fortunes in doing so right here on Earth, and in the process develop, debug, and put “on the shelf” a ready-to-go industrial technology that could be a backbone of early lunar and Martian industrial settlements. We developed this idea in more detail in MMM # 16, June 1988. But while glass fibers are finding their way into new concrete formulations, no one has bothered to try to earn a buck by taking glass composites themselves beyond the laboratory curiosity stage.

Metal alloys are another area deserving more research. Most pure metals have poor performance characteristics and benefit greatly from inclusion of varying amounts of “alloying” ingredients. Yet it does not seem to dawn on most space supporters that the Moon’s

considerable “on Paper” wealth in iron, aluminum, magnesium, and titanium – the four “engineering metals” – does not guarantee the easy and economic production of the various alloying elements we are used to using to improve the performance characteristics of each. Steel needs carbon, in poor supply on the Moon. Aluminum alloys generally are rich in copper, a ppb trace on the Moon. Metallurgists who step in to research more “frontier-feasible” alloys which are still “serviceable” may end up producing alloys with considerable marketability here on Earth.

Synthetic Chemical Feedstocks

Mars enthusiasts never tire of pointing out that the other planet is richly endowed with the elements that are the basic organic and synthetic building blocks: hydrogen, carbon, and nitrogen (oxygen being taken for granted as ubiquitous). But in fact, most plastics and other synthetic materials are normally not “made from scratch” but from nature-processed cooking ingredients more or less easily refined from oil and other complex petroleum reserves (tar, shale, etc.) We are spoiled. But at the same time, countries not blessed with such reserves are at the economic mercy of those who do have them. If economical “from scratch” methods of meeting such synthetic materials needs could be developed by chemical engineers of the organic-persuasion, this would be of great economic value for many nations. And, as always, the power to equalize is the power to make money.

Bob Zubrin showed the world that methane could be easily made from carbon dioxide by using a totally automated “sebatier reactor”. Apparently, the chemical pathways exist to make other simple organic molecules that could serve as synthetic feedstocks by a similar or adapted sabatier process. Applying such techniques here on Earth might prove profitable. If countries blessed with natural gas, but not with oil reserves per se, could build the equivalent of a petrochemicals industry upon the simpler rudimentary assets of air and natural gas, this could prove a powerful economic equalizer for them. And anything additional to methane that we can learn to produce by these techniques, will also have the happy effect of putting “on the shelf” pre-developed and pre-debugged technologies ready to go on Mars at a much lower cost to the frontier.

In the original oil crisis, research began into using certain plants to produce oils and other petrochemical-like feed stocks. There is money to be made here on Earth by pursuing such agricultural alternatives. And happily, many such advances will be useful to opening the Martian and lunar frontiers. We can learn to be much less dependent on wood, paper, and synthetic organic products. But if we are not to be confined to the constraints of a “New Stone Age” on the space frontier, alternatives to conventional petrochemicals must be developed. And we can make money here and now doing so.

“Biospheric” Technologies

Biosphere II was an attempt to come up with a centralized solution for biological life support. Though the specific experiment “succeeded” only by “cheating,” in fact we learned much. The only thing that can be dismissed as a failure, is an effort from which we learn nothing. It is much easier to dismiss than to criticize constructively, and when reading such negative reports, one should always discount for the temperament of the reporter.

Beyond Earth, settlements must reencradle themselves in mini-biospheres that each settlement must establish, grow, and maintain. This will entail the unprecedented challenge of “living immediately downstream and downwind” of oneself. Pioneers in space will not pollute because, unlike us spoiled terrestrials, they cannot “get away with it,” putting off pollution problems to the next generation.

But to attempt to do this in a centralized way is just as ineffective as are centralized methods of growing and controlling economies. Modular “market” techniques must be the basis of any effort to establish, grow, and maintain space frontier biospheres. Systems that treat human wastes at the origin and greatly reduce any residual problem that must be handled on a larger scale, are much better suited for non-ivory tower communities of non-static size.

In fact, many people are experimenting with “living machines” and other techniques to integrate plants, air quality maintenance, and waste treatment in unit-sized systems. Such an approach will not only make city-size biospheres a more practical prospect, but will also enable appropriate-size life support systems for spacecraft on long deep-space journeys. We need technologies that are “scalable.” In contrast, solutions addressing fixed, static size situations are not helpful at all.

The terrestrial profit prospectus of modular biospheric technologies is immense. In the last few decades we have seen the emergence of gargantuan urban complexes in the third world. For the most part, such cities have grown and continue to grow faster than urban utilities can add capacity to keep up with them. The pressure on centralized water treatment facilities is unreal, and the loser is public health. Inexpensive ways to tackle human wastes home by home, unit by unit, that freshen interior air, and provide additional sources of food, would do much to make such monster “blob” cities more livable. There is a market! Let’s make money now, and learn how to do space right in the process.

The Gospel of “Spin-up”

The traditional fare of the space faithful is what has long been known as “spin-off.” NASA spends hundreds of millions or even billions of dollars developing new materials and technologies that the agency needs for use in space, all at taxpayer expense. Then these technologies are made available to industry at large, providing the usual litany of “benefits for the public” of space research.

“Spin-up” would take the opposite path. Enterprise would brainstorm technologies deemed vital down the road in space for their potential Earth-market applications, so as to make money now. The frosting on the cake is that technologies also needed on the space frontier, would be predeveloped now at the expense of the consumer, rather than the taxpayer (YES, there is a world of difference in this distinction), and would be ready in time “ready to go” and at relatively low cost to those who will in due course attempt to open the space frontier to genuine self-reliant local resource-using communities beyond Earth’s biosphere and atmosphere.

“Spin-up” is a more economical and efficient way to get the research done in a timely fashion. It is the only path not dependent on uncontrollably fickle political tides. And in so far as it is consumer-user financed rather than tax-payer-forced, it is a more moral way to achieve “minority goals” such as ours.

But above all, the “spin-up” route is the only sure way to get the job done. To rely on the traditional route means putting all our eggs under a hen that is not motivated by instinct or any other reliable force to hatch them. We have complained before that those who want to open space by political coercion are abdicating the responsibility for the fulfillment of OUR dreams to those who do not share them, and cannot be made to share them.

If you are blessed with the talent to be an entrepreneur, consider that getting involved in pioneering some of the terrestrially useful technologies needed also in space may do more to guarantee the timely opening of the real space frontier than any amount of seemingly more direct involvement in micro-satellites and micro-launchers.

We do not expect those with electronics and propulsion expertise to get into totally different fields. Each of us must do our thing. Rather, we want to encourage and set loose the untapped talents of others who have not realized that they have a potentially powerful role to play, however indirect. The important thing in opening space is not instant gratification. It is well-targetted patient hard work.

If you are a young person not yet established in a career, consider chemical engineering, poor ore mining technologies, new materials science, “from scratch” synthetics production, bioextraction technologies, molecular mining technologies, experimental agriculture, and modular environmental systems as rewarding fields in which you can make a difference, both down here and out there.

Rocket science can take us to other worlds. It cannot enable us to do anything useful once we get there. Iridium may have failed. It was a detour. There are other, ultimately more powerful and profitable ways to build up to a space frontier economy. Do not waste a moment wallowing in discouragement at recent set-backs. In the end, they won't matter. <PK>

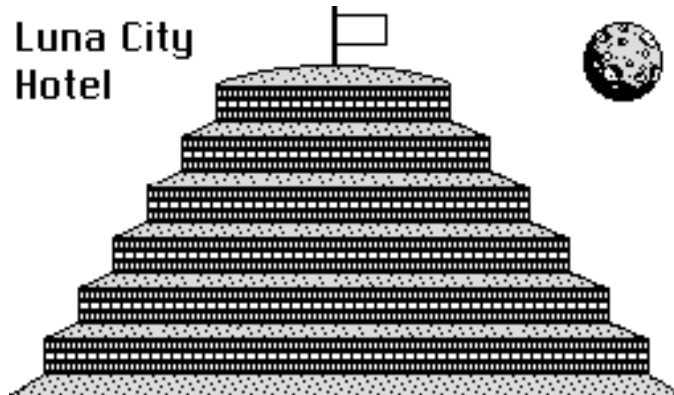

Can we respect the lunar landscapes, yet build structures that stand proud?
Read the following article.

MMM # 137 August 2000

**Taking Back the Surface:
Above Surface Architectures for Moon and Mars Habitats**

By Peter Kokh

Background Readings from MMM Back Issues

MMM #1 DEC '86, p 2, "M is for Mole"

MMM #55 MAY 1992 p 5. "Skyscrapers on the Moon?; p 7, "Moon Roofs"

MMM #75, MAY '94 pp 4-7, "A Successful Lunar Appropriate Modular Architecture"

MMM #109 OCT '97, pp. 3-11 "Luna City Streets" specifically, pp. 7-8 "Custom Frontages"

MMM #111 DEC '97, pp. 4-5, "Lunar Skyscrapers: shattering 'low' expectations"

MMM #122 FEB '99, pp. 5-7, "Shielding: the 'B' Options"

MMM #125 MAY '99 pp. 3-4, "A Levittown on the Moon"

Forward:

The spirit of the "Manifesto" in MMM was born the instant I walked inside an innovative earth-sheltered home some 30 miles NW of Milwaukee in the rolling glacier-carved Kettle Moraine countryside of SE Wisconsin in the Spring of '85. Eight feet of soil and grass covered the concrete ceiling, and only the garage door was exposed. Yet I was standing in pools of bright sunshine and looking straight ahead out onto the green meadows through picture windows in the walls. The sun came in through mirrored shafts. The views also were channeled down a shaft via a pair of very large mirrors on a 45 degree slant. That you could use devices like this to bring the joys of surface life down underground with you was a revelation. On the Moon and Mars, exposure to the waves of cosmic ocean weather pounding on the barren global coast meant refuge under a blanket of moon dust or Martian regolith. Yet we could be comfy.

But the regolith serves as a blanket with this difference. While we live below a blanket of air on Earth we still live above the visual surface. On Moon and Mars, the surface of the regolith blanket IS the visual surface. It is one thing to find ways to enjoy access to the sun and views. But perhaps many Lunan Pioneers will still regret, even resent, the "loss" of the surface from

which radiation, solar flares, and other cosmic inclemencies would seem to exile us. The rebel cry will be to “take back the surface.”

In these pages we have tried to sketch a rich and varied menu of supportable “out-vac” activities including sports. And we’ve suggested ways in which our settlements could still have “skyscraper”-jeweled centers. And we’ve illustrated how lavatube settlements could boast elevator shafts to surface observation areas and surface-side restaurants. Yet, as comfortable as we might make life under the surface, some will still yearn to recapture more of the life on the surface. Can we?

Inspiration in Utah:

It was early afternoon on a hot summer day in Utah. I had been immensely enjoying my window seat view of the Colorado Rockies and the Utah rockscapes along Interstate 70, this past July 20th. This treat of exploration was a fringe benefit of going by Greyhound to the Las Vegas opening of the Moon Society Organizing Conference. Colorado’s Glenwood Canyon, and its feat of Interstate engineering was fresh in my mind as the scenery started to get fantastic again west of Green River, Utah.

Following on my road map, I imagined myself on Mars as we cut through the San Rafael Reef (where there had been no road at all prior to I-70). Then we entered a broad valley with sweeping views -- Castle Valley between I-70 exits 100-114 (approximately). I didn’t have to wonder long at the origin of the name. To right and left there appeared one butte or mesa after another, each of them with rusty ochre rock cliffs bearing a very pronounce horizontal stratification along with texturing vertical lines cut by falling water and erosion. The tops were covered with desert soil. And a fairly uniform talus slope of erosion debris gently bermed these “castles” so they seemed to be extruded from the valley floor itself. I could imagine the geology that created these features and will make it a point to research that in detail.



As the majority of my fellow travelers slept or read or looked the other way in inexplicable boredom, I was cycling between visual ecstasy and brainstorming imagineering of fully shielded surface homes on Mars and the Moon. The vertical walls with their strong horizontal character were retaining walls taming the regolith that safe-hid homesteads inside. We could transcend the mole hill, and reclaim the surface -- with strong architectural character!

In MMM # 122 FEB ‘99, pp. 5-7, “Shielding: the ‘B’ Options,” I had talked about a similar way to contain and sculpt regolith shielding mound.

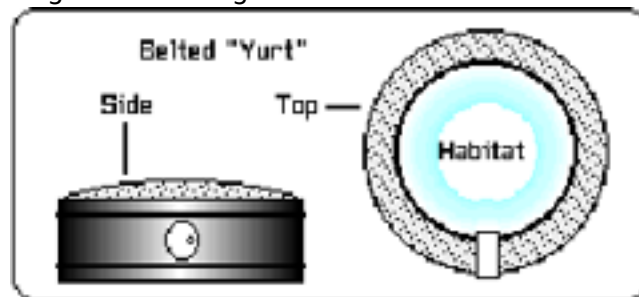

While the structure of what I was now seeing so vividly in my mind’s eye was much the same, the idea of the retaining wall being made of rock or cast basalt or concrete forged out of the local regolith, paying homage to that origin in its coloration, and being so strongly textured as to give equal testimony to the host planet and to the intelligence that now adopted it as “home” -- that vision was fresh flash.

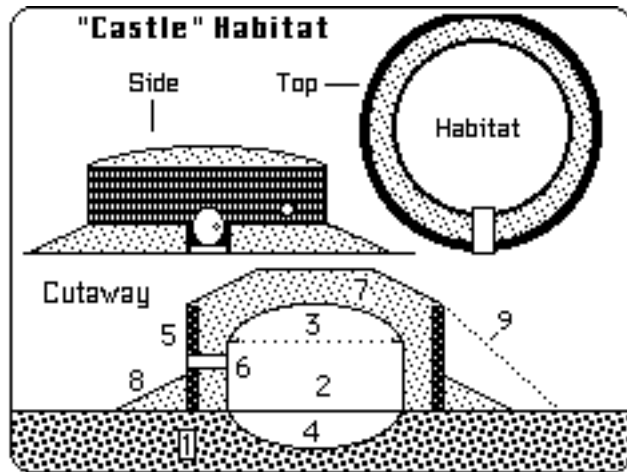

KEY: (1) surface, minimally excavated to nest the rounded bottom of habitat hull; (2) Habitat Hull, in this case a squat vertical cylinder with round end caps; (3) vaulted, cove-lit ceiling; (4) "basement" area for utilities and systems and extra storage; (5) the "castle" rampart retaining wall; (6) shaft for "window"; (7) regolith shielding and (8) berm; (9) slope of shielding without a retaining wall

The retaining wall is shown above with a berm of regolith around its periphery. This berm is not dictated by either structural or shielding considerations, but rather by aesthetic ones. Without a berm, the habitat appears to be a foreign object alien to the Moon (or Mars) and just "dropped or set out upon" the surface. With the berm, the habitat appears to be a natural extrusion from the surface, just as the castle rock outcrops in Utah seem to be (and are) a natural part of their valley. And that is the whole point. Our goal is a "selenophylic" architecture that "takes back the surface" without "assaulting" it.

In some areas the lunar surface has been "gardened" into regolith by eons of micrometeorite bombardment to a depth of up to five meters (16 ft.) In other areas the loose moon dust gives way to broken bedrock only a few feet down. In terrain like that, this surface "castle" shielding construction method might actually work more "with the grain."

Openings to the outside

This type of surface construction lends itself more easily to individual home airlocks and vehicle docks to the surface, though one could still choose to rely on public access points, e.g. along pressurized city streets. What about windows? In "castle wall" construction, the habitat is actually at or above eye-level with the surface. The "periscopic" picture windows suggested for "buried" habitats might seem out of place (even given the higher vantage point.)

Friesen talks about an alternative movable shutter system that might work well for our "above surface" castle homesteads. One might still opt for a "no moving parts" sight path shielding via a "sideways periscope." An illustration of a horizontal zigzag light shaft is shown at left, below:

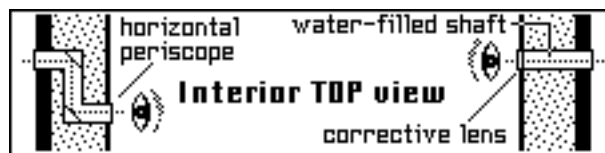

Right, above: Advanced possibilities include a water-filled shaft, with active thermal and density management to maintain structural integrity.

"Castle" Retaining Wall Materials:

Showcase vertical retaining wall can be built of various "lunar" or Martian materials:

- Metals: cast iron (rust free in vacuum), magnesium (non-oxidizing in vacuum), etc.
- Concrete: fiberglass reinforced steam-cast cement
- Sulfur Cement (no water or steam required)

- Sintered Blocks (easy to make but requiring more assembly even with a mortarless lego-type shape)
- Cast Basalt

Metal and Composite panels (e.g. fiberglass reinforced cement and sulfur cement) can be made thinner without sacrificing strength. In light gravity, the outward pressure on the regolith retaining wall would not be especially great.

At first, the components would be made to order by a manufacturer. The first customer might be a wealthy individual (and his/her architect) or, more likely, a major homestead builder-developer who wants something special and distinctive. If and when the settlement begins a major population expansion, manufacturers might arise for whom a variety of such retaining wall panels are a major product line.

Assembly method

The ideal “castle panel” is something easy to produce and which requires a minimum of assembly. Arc panels short enough to stack easily and light enough to handle, yet long enough to keep assembly to a minimum, could be “keyed” for easy connection. Below is just one type of “key” design.

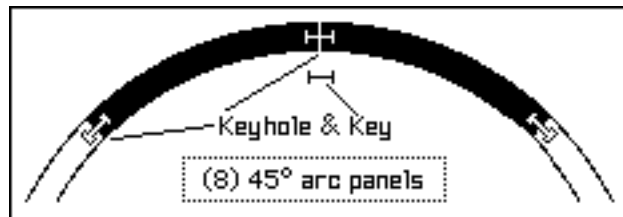

Appearance: texture, pattern, color, etc.

A one-step and thus very attractive option would be to cast the panels in textured molds, a common enough practice on Earth for cement façade panels. Such panels could be cast with smooth or rough, vertical or horizontal ribs, each option with a distinctive overall “look” in texture and shading.

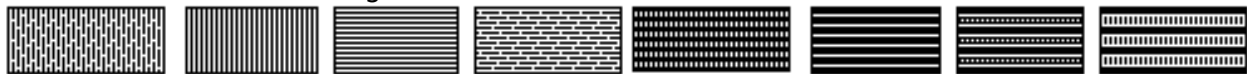

Cement panels and sintered block would take color hues and shades that complement the regolith from which they are made. But they would stand out from the regolith shielding mounds both through their manufactured texture and from their vertical orientation and the play of sun shadows.

Cast Basalt and Cast Iron panels would be rather black; Magnesium silver metallic; Sulfur Concrete a pale yellowish grey. Ochre panels could be made from cast iron panels steam-rusted on the face side in the factory before assembly. It might pay to experiment with various rough texture surfaces to try to find some that would “hold” a dusting of white calcium oxide (lime). A whitewash of lime in sodium silicate would be a more expensive option and may not prove durable under constant thermal stress from dayspan/night-span/dayspan temperature changes.

Concrete retaining slabs could also be cast “smooth” for covering with decoratively glazed ceramic or cast basalt tiles if either the developer or intended homeowner so desired. Possible patterns are endless. Here is but a small teaser sample:

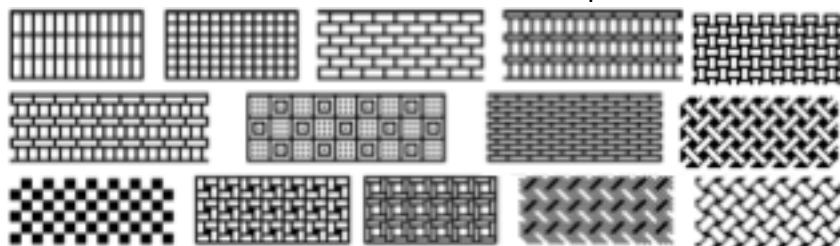

If a non-regolith color palette is used, the color combination options are likewise vast, even if limited to Moon-sourced metal-oxide glaze pigments. These will include black, rust, green, white, blue, pale yellow, and various blendings of the above. Bright red, yellow, and orange would be unlikely.

Preferably, each panel would be “tiled” in the pressurized factory, allowing quick installation with minimum EVA. To put up plain tile-backer panels, pending a later greater selection (e.g. as more color pigments and glazes become available) would allow quicker initial assembly but then look a bit ugly for an indeterminate amount of time. The calculated risk is that custom finish cladding is a “postponable” expense and may never be completed. Perhaps the smooth tile-backer finish could be minimally textured to be presentable ‘as is.’

We want to personalize our homes, not just the sanctuaries inside, but the public faces as well. We previously discussed how their entrances upon the city’s pressurized streets will create opportunities for personalized expression.

In “Moon Roofs,” we described ways people could customize and style the surface of the regolith mounds that protected their habitats. “Castle wall” construction offers us welcome new ways to personalize our homestead “exteriors.”

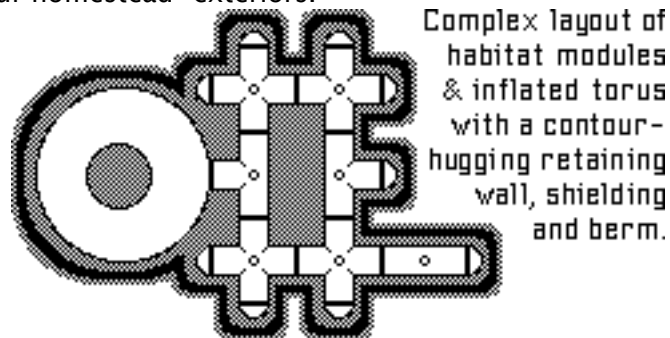

Variations on “Castle Home” Shapes: This surface-exposed “castle-panel” architecture is not limited to the simple one or two story vertical cylinder type habitat. Go for the layout you want! Then erect a retaining wall that outlines the exterior wall footprint.

Doing a whole Settlement or Neighborhood:

Just one residence designed in this manner might look out of place. A whole town of habitats built with similarly textured retaining walls would be rather striking, much as are the Spanish tile roofs of the University of Colorado at Boulder, or the red brick colonial buildings of the Univ. of Kentucky in Lexington, or the adobe buildings of the University of New Mexico in Albuquerque. Keeping to a uniform architectural “language” can yield visually impressive results but yet suffocate the individuality of those who must live in them. In our case, if all the retaining wall elements are similarly textured and colored, this would quite defeat the whole purpose of including a personalizable public facade to one’s dwelling – a seeming Catch 22. Somehow I think that the similarity of “above surface bermed homes” will prevail and give the settlement a distinctive feel even if patterns, textures and colors, as well as footprint shapes vary widely from home to home as they should in a healthy and vigorous settlement. Standards of “conformity” should be very generous in their interpretation. Neighborhoods might well vary in the styles that are characteristic of them. The Home is the very essence of personal expression. It is very important to allow this personality to be expressed on the public exterior as well as in the interior.

Managing shielding “with style” in this fashion might first appear in “upscale” settlement neighborhoods. Or perhaps it will first appear in the isolated inter-settlement and off-road reaches of the endless global boondocks. Indeed, isolated outposts may put a premium on “standing out” against the moonscape, yet “being one” with it. “Castle wall construction” in all its possible varieties should appeal to the hardier breed of “rural” pioneers.

Whether set out on a broad plain or on high ground commanding views in many directions, hotels and inns, general trading posts, and other types of country outposts built in

this fashion would catch the eye from afar, welcome tired travelers, and signal the pride within. Wherever it takes hold first, we can expect a lot of experimentation within this paradigm.

There's more to a town than homes:

Variety versus conformity is not the only issue. "Castle" homesteads must still be connected by pressurized, shielded thoroughfares. These also could be minimally set into the surface with bermed walls taming the shielding mounds. That might be taking the architectural idea too far, detracting from the homesteads themselves. On the other hand, public architecture could be used to "set the theme" and example for privately built individual homes. That is something Lunan architects and the people who hire them must work out for themselves. And a nontrivial issue is that such features for public assets come with an additional price tag -- additional taxes.

Conclusions

In the previous articles cited ("Moon Roofs," "Skyscrapers on the Moon," "Lunar Skyscrapers: shattering low expectations," "Luna City Streets") we had already laid the grounds for considerable diversity and individuality. Both articles dealt with ways Lunar and Martian settlements could escape dismissal ("Once you've seen one molehill city you've seen them all!"). In this article we've tried to develop additional architectural options. Combine that with further options such as lavatube settlements and cities within megastructures, and it becomes quite clear that while all Lunar and Martian settlements will be recognizably Lunar or Martian respectively, it will not be true that once you've seen one, you will "have seen" the Moon or Mars.

Earth cities are recognizably "Terran" -- they are outdoors in a planet wide biosphere. Yet variety and diversity abound. We think that as the lunar and Martian frontiers develop, initial monotony and uniformity will in time give way to a quite surprising creativity and innovation of expression. Variety is the spice of life, and we will not lose our need for it by transplanting ourselves to other less motherly worlds. The Moon and Mars similarly challenge us with their lack of breathable atmospheres and exposure to the waves of the cosmic ocean. But there will be more than one solution or set of solutions to those challenges. The easiest is but the first.

Architectural diversity encourages tourism. Visitors from Earth will have several settlements on their itineraries. But it will also be healthy for the settlers. They will have attractive and interesting places to visit, or escape to if only for a badly needed change of scenery, on their new home world.

External shapes and forms are but one vector of cultural diversity. They will be complemented with a diversity of arts and crafts, clothing fashions, performing arts, sports, and more. It's about making both the Moon and Mars whole new Worlds, captial W, each with a "world-full" of variety and diversity to forever delight. The limited diversity of the stark and lifeless landscapes will work to encourage special attention to all these other avenues of making places special and unique.

<MMM>

MMM # 138 September 2000

The Black Sky "Blues"

Coping with "Black Sky Country"

By Peter Kokh

Foreword

On Earth we enjoy a brightly illuminated sky. If it isn't clear and blue, the clouds are bright. The darkest storm cloud is far brighter than pitch dark.

On Mars, the sky seems to be "salmon" hued, though there is one researcher who insists that this is only the case during and after dust storms. The point is that on Mars, as on Earth,, the daytime sky is a source of diffused ambient light that makes viewing the landscapes easier. Earth and Mars are "bright sky worlds," a gift of their atmospheres.

On the airless Moon, however, the sky is pitch black during dayspan. In the glare of the unfiltered Sun the naked eye cannot see even the brightest star. During the near-side nightspan, Earthlight will cast a glare from up to eighty times as bright as that of full moonlight on Earth. Even a partially lit Earth will also blot out most of the stars. Only on the lunar farside, forever turned away from Earth, do the stars come out during nightspan – and with a brilliance we cannot imagine. But at no time anywhere on the Moon is the sky itself “bright.”

We’ve all grown up with the night. We don’t mind it. Nighttime darkness is only temporary. With dawn comes welcome visual relief. On the Moon, that relief never comes. Our pioneers will be transplanting themselves to “Black Sky Country.” And that can have long-term psychological consequences.

With the black sky even at “high noon”, the contrast volume between surface and sky is intense. Shadows are bottomless visual pits. This will cause some eyestrain. Of course, this will be more of a problem for those who spend a lot of time out on the surface – in the “out-vac”. But it will affect those who spend most of their time in pressurized spaces as well: in what they see through various types of “windows” (visiscreen, periscopic picture windows, etc.); it may affect “skylights” as well.

Coping with Black Skies

To the extent that the “Black Sky Blues” do become a subtle morale problem, and this may differ from individual to individual, ways of providing deserve serious attention. Here are a few, we can think of for starters (and we invite readers to send in additional suggestions):

- **Electronic Windows**

Whether we call them telescreens, visiscreens, or something else, electronic images of the surface scene outside offer, for good as well as mischief, the opportunity to be manipulated. The viewer may be able to select a sky color and brightness to his or her liking. The viewer, much like an Internet browser, would then “interpret” the black areas at the top of the picture accordingly. Pick a light gray to go with the moon tones, or a smoky blue: or, if you’re a visiting Martian pioneer, a dusty salmon. Those homesick for Earth can pick a brilliant blue. The idea is not to deceive oneself but to prevent eyestrain – if it has become a personal problem.

- **Spacesuit Helmet Visors**

Would it be possible to give the visor some differentially reflective coating that would “brighten” the sky, even if just a bit, without interfering with clarity of visibility of the moonscape? We throw out the challenge. If this proves feasible, could we do something similar with regular windows and periscopic picture windows (Z-views)?

- **Skylights & Clerestory Windows**

On Earth, water vapor in the atmosphere scatters the sun’s rays so that light seems to come uniformly from all directions. Our atmosphere is a natural “diffuser” with a bluish cast. For those windows meant to bring in light but not necessarily the views, could we produce some sort of frosted and translucent, but not transparent, glass pane that will not only let in sunlight but appear itself to be bright, giving the illusion of a bright sky beyond? Again, we throw out the challenge. One might experiment by holding up various kinds of existing glass and diffusers to a streetlight against the dark nighttime sky.

Windows, skylights, and clerestories of this type will be desirable not just for private homes but for sunlit pressurized streets and other “middoor” spaces, sports facilities, highway waysides, etc. Passive light scattering panes to the extent that they present a satisfying illusion of a bright sky could become standard, or at least common.

Without real experimentation, we would not pretend to guess what will work best. But we should be trying a lot of things, including foamed glass, aerogel, special coatings or laminate layers, etc.

Meanwhile, this standby:

Some may not want to wait for such tromp d'oeil developments, or disdain them as dishonest. And it may turn out that none of these suggestions will be possible to realize in a truly satisfying way.

There is another, simpler way. Pressurized habitat structures and modules will commonly have curved surfaces. We'll need to install flat floors, of course, but the curved ceilings of spheres, cylinders, and toruses present an opportunity. Finish them with a light-absorbing matte texture and illuminate them with cove lighting. Give the finish – or the light source – a subtle blue cast, and Voilà, the appearance of blue sky. That these vaults offer greater ceiling height will only enhance the effect.

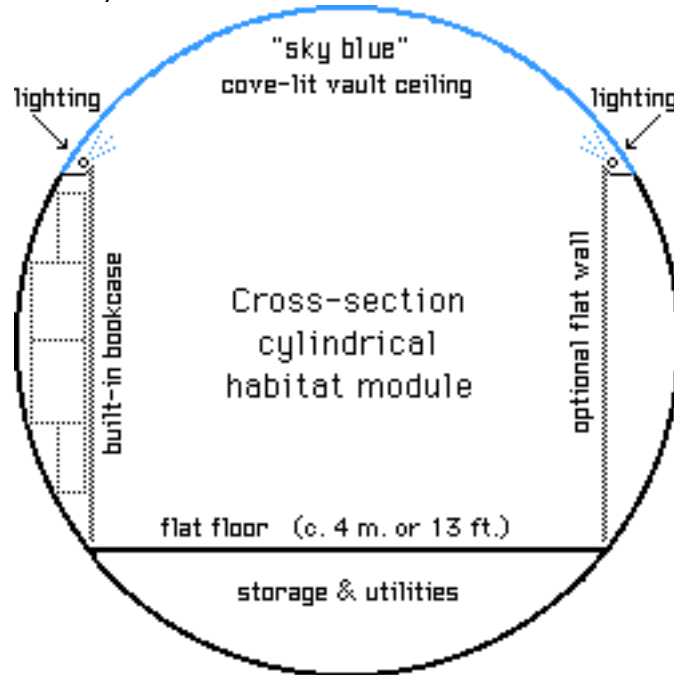

We can in effect, recreate the familiar blue sky indoors on the Moon. On Earth, where all we have to do is step out-side, this hardly seems like a worthwhile extra expenditure. On the Moon, suggestively bluish cove-lit vault ceilings may become the norm.

Cove lighting, especially if it is really "sky-bright", will reduce the need for other lighting: floor and table lamps, wall sconces, and especially ceiling lights and chandeliers. Strong indirect ambient light reflected everywhere off the vault ceiling from cove light strips hidden from view will create a positive psychological "atmosphere".

It's understandable if some residents might prefer the flat, white ceilings they are familiar with on Earth and to get their daily dosage of blue skies in common "middoor" spaces such as pressurized roadway tubes. Below is a suggestive illustration from MMM # 53 March '92.

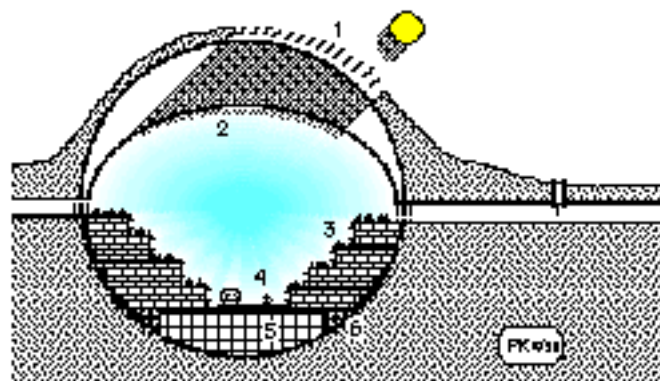

THE RESIDENTIAL STREET ('HOOD) AS THE MODULE

Cross-Section of cylindrical module 40m x 700 m: [1] shield louvers let in sunlight; [2] suspended sky-blue diffusing "sky" – air pressure same on both sides; [3] terraced residential housing with rooftop gardens; [4] thoroughfare running the length of the (neighbor)'hood; [5] light industry, shopping, offices and schools; [6] conduits for utilities.

At first, roadway tubes will be of a much more modest scale, of course. But other "middoor" spaces (pressurized common spaces neither inside private quarters nor "out-vac" on the surface) such as school recreation spaces, public squares, sports arenas, and "park and picnic areas within agricultural modules all are prime opportunities for faux blue sky ceilings.

During the two week-long nightspan daylight (on an artificial 24 hour schedule) could be simulated by using electric cove lighting aimed at such vault ceilings. During the equally long dayspan, sunlight could be indirectly channeled by mirrors to reflect on the vault-ceilings full-time, or shuttered to simulate night conditions on a 24 hour schedule.

Out-vac Blue Sky Simulations

What about simulating blue skies outside the settlements, out on the surface? This might be very desirable for frequent inter-settlement travelers, truckers, and others whether they spend a lot of time in such conditions or not. Certainly, one could design emergency solar flare shed vaults and other covered roadsides, even if unpressurized, lit from below, thus providing "bright skies" of a sort, whether they be blue, white, or light gray.

One can foresee a day when many thousands of people live on the Moon in several settlements. There might then be one or more heavily traveled surface corridors. These could be covered with shielding vaults lit from below, open to the vacuum. Such lunar "superhighways" would make for safer, more comfortable driving conditions, day or night.



Someday, settlements may be built within great megastructures with soaring ceilings. These too could be designed to offer bright blue skies. But meanwhile, the use of cove-lit vault ceilings in habitat and other interconnected settlement modules will go a long way to shake those "Black Sky Blues" or at least help inoculate the settler pioneers against the accumulative visual deficits of the "magnificent desolation" of the lunar terrain.

But hopefully, someone will pick up on the other challenges we've put forth, of individually tunable "browser-like" video screens, special light scattering glazing options, and smart helmet visors.

The "Black Sky Blues" is something we need to take seriously. It poses an acculturation challenge unique to the Moon and other airless worlds which future Martian settlers will not have to face.
<MMM>

MMM # 145 May 2001

The Independent Lunan Farmer

By Peter Kokh

David Anderson, Abingdon, VA, has some questions:

Peter, I'm thinking about Communities in Space. Is there a Bachelor Farmer equivalent on the Moon in 2050? How do the low-tech families earn their living? Does "earn" mean what it does here and now, when you have to earn air and water as well as food and shelter? Who subsidizes?

Readings from MMMs Past:

MMM #13 MAR '88 Rural Luna MMM #85 May 1995 p 7. FARM TARNS

Basics:

The Moon is 14.5 million square miles of quintessential rural boondocks. A settlement or two or three will not change that. There are a lot of other places to hunker down, if one is bold enough, or "foolish" enough, to try to go it alone. Civilization will cluster tightly around the main settlements and the roads that connect them.

Safety and survivability will increase with numbers, and the Moon may always be highly urban. That said, one must keep in mind that a lunar city must "include" the farms necessary to produce its food and fiber, and maintain the quality of its air and water. The lunar city will be "whole" as no Earth city has been before. (Island city-states such as Singapore and Hong Kong offer faint analogies.)

But if one were to set up a private farming operation with a small band of determined pioneers, it would be foolish to locate far off the beaten path. It will take a large pool of people to make any reasonable quorum of the necessities of life on the Moon. If that population is split between communities, some major, some small, all of them had better be linked by regular trade routes.

The smaller the community, the more likely it is to experience an emergency that it does not have the wherewithal to handle. Equipment will not be so simple that a local blacksmith can make do. The farm must be successful enough to sustain its own biosphere, something every terrestrial farmer takes for granted as a given. The farm must maintain not only the quality of its atmosphere and water reserves, but the integrity of its pressurization envelope or hull.

Needs can be kept simpler than in the towns and cities, but not so simple that a lone nuclear family could manage them. A rural farming operation would stand a better chance if it has a couple dozen working adults at the minimum. A superfamily commune might work. Or a localized cooperative cluster of nuclear family farms might thrive.

Another possible formula, for those with the right special stuff, is the monastery farm operation. Monasteries can be sizable communities of highly motivated individuals with minimum needs for gratification from consumer goods.

The essential requirement is a critical mass for a viable biosphere, and for the mix of necessary chores. The smaller the farm "family," the more overburdened with chores will each member be. The original goal, a satisfying life, may be a casualty.

The critical difference with the situation on Earth, is that, on the Moon, one cannot "live off the land." The land is not "fertile" as is. Air and water, rainfall and fertile soil – these are not givens. The farmer cannot just plant seed. He has to create his own fertile valley. It can be done. It will not be easy.

Reasons to establish an independent rural farm:

The "climate" of the settlement biosphere may not be suitable for the growth of the crops species one wishes to plant. One may want a climate that is colder, has periodic frosts, is more tropical, more moist, or more dry. While special climates can be effected in semi-separate parts of a main settlement, it may be simpler to have total separation.

"Variety is the Spice of Life." Specialty export and domestic crops overlooked in tightly planned and eco-balanced settlement biosphere farming operations might include:

- coffee, tea, wines and brandies
- fruit and vegetable specialties
- fish farming, bees & honey
- pharmaceutical feedstock plants
- spices & herbs
- meat producing animals and animal products
- additional fiber producing plants (cotton?)
- dyestuff plants, and more

Practitioners of one type of farming will want to experience for themselves the proper temperate, subtropical, tropical, or arid climate -- that is, in their own habitat area common spaces, not only just in the farms. Climate is interwoven with culture as well as with agriculture. That is the total experience everywhere on Earth.

Settlement zoning and land use practices may not favor the farming or horticultural methods to which one is attached. Thus the settlement may have a decided tilt toward hydroponics, as it is more stingy in its pressurized space demands. Others may be determined to try a regolith-based analog of more traditional soil farming needs.

There may be a need to quarantine some crop specialties from others, reducing risk of transmitted blight and disease. That works both ways, and the settlement may put out the 'not welcome' sign even as rural farmers declare their own intent to sequester their chosen crops.

Many brought up in agricultural settings on Earth will cherish the rural experience and not want to be a part of the city experience, however large an agricultural operation the larger settlement needs to integrate into its biospheric underpinning.

Filling out the rural farmstead economy:

The challenge is to find the right formula, and it will differ from operation to operation depending on the specialty crop or mix of crops, on whether or not the farm produces other goods as by products or in a supplemental industry. It is not impossible that the special character of the local regolith that is ideal for the farm's specialty crops is also a source of some element or substance not mined and produced by the settlement(s). Wherever the farm is located, other advantages of the site should be explored.

If the farm is located convenient to a main trade route highway in order to ensure its produce has access to markets, its income can also be supplemented through offering roadside services:

- vehicle repairs and servicing
- bed and breakfast lodging
- produce and byproducts market

Such farm-to-market route-side locations are essential. A "Tea & Sugar"* fleet of trucks could ply the route regularly, supplying each farm with its needs, and taking farm products to the other farms as well as to the main settlements. [* reference to the special "Tea & Sugar" train that serves small outposts in Australia's Nullarbor Plain.]

Rural farms will not be alone in the vast stretches between settlements. Scattered mining operations, science outposts, and tourist stops will keep them company. In the settlements, outfitters and supply houses will arise to serve their common needs. True isolation will be in no one's interest. The rural farm might also supplement its income as well as shore up its own labor pool by offering working farm vacations to "city folk" who might eagerly pay for the privilege as an ideal change of pace and change of scenery vacation.

The rural farm could also offer "farm camp" experiences to settlement young. Such extension activity will also serve to introduce fresh cultural experiences into both rural farm and larger settlements. Granted, there will be reclusive rural farm hamlets that may want to avoid such cross-pollution!

Not to forget outside markets:

Rural lunar farms need not justify their operations in the lunar settlement market alone. Almost any food grown on the Moon with lunar oxygen and lunar-sourced macro- and micro-nutrients may be cheaper to purchase in any space venue, even low Earth-hugging orbits, than food raised on the Earth's surface, no matter how much more cheaply and efficiently, but brought up the steep gravity well at high fuel expenditures. Only special delicacies or treats available from Earth alone will make it onto space pantry shelves and into space eatery menus.

Rural Farms add to the total biospheric mass in place on the Moon, increasing the overall chances that lunar civilization will thrive and be indefinitely viable. As such rural lunar farms can play a key role in the future of the Moon. <MMM>

"The Moon will determine whether we will become a space faring species or not."

"Earthpatch"

Anchoring Lunar & Martian Homesteads

EARTHPATCH By Peter Kokh

Stating the Question

In the past two issues of MMM (#s 146, 147) we talked about the effect lunar habitat construction modular architectures and building materials would have on early settlement interior decor styles. This month we want to talk about something even more basic -- the effect that the total absence of a host biosphere on the Moon (or Mars) will have on frontier homestead interiors.

On Earth, except in the driest of deserts and the rockiest of mountainscapes (and at sea, of course), human habitat structures are inanimate islands dotting the green continuum of the host biosphere. Earth is still Eden!

On the Moon and Mars, the host continuum is inanimate, barren, sterile, and life-snuffing. And it is intensely monochromatic -- either shades of gray or shades of tan. The table has been turned "180°."

It is pockets of green life, "Patches of Old Earth" that we need at the core of each frontier homestead to provide the same reassurance as does the hearth on Earth.

To the designer of initial short-term occupancy starter Moonbases, talk of garden green spaces within habitat (as distinct from closets of LED-lit plant trays in hydroponic racks) is sheer extravagance, a luxury that is quite out of the question. But to the designer of frontier habitats intended to serve as lifetime homesteads for pioneers who are ready to commit to forsaking return to Earth indefinitely, this is not a luxury, but an absolute psychological necessity. We are not talking about what is needed to keep our bodies alive. We are talking about what is needed to keep spirits alive -- and productive.

Spacecraft hardware engineers operate in a feedback vacuum quite unlike CEOs of large corporations who have learned that increased perks mean increased productivity and increased profitability. To "get" you have to "invest," -- the corporate translation of "no pain, no gain." Green Oases at the core of frontier homesteads on alien life-hostile shores are precisely the investment needed to tilt the steep odds against successful off-world transplantation of humanity towards odds in our favor.

Supporting Argument - Modular Biospherics

Given that there will be community agricultural areas that will grow both in number and in total area as settlement populations increase, given that these agripod units will be designed to provide complete nutritional balance for all, given that these units may be designed to provide adequate bioassist air and water recycling -- given all that, why would we also need in homestead gardens? There may well be more than these six good reasons:

1. Interior air quality will be a problem. We all know how quickly the air inside a tightly shut space becomes first stale, then sickening, and finally suffocating. Now we can rely on chemical scrubbers and community fresh/stale air ducts and fans, or we can hedge our bet with abundant house plants to keep air fresh and sweet. In the tightened up homes of today, we rely on air exchangers to replace stale air with fresh. On the frontier, "airexchangers" will not be an option. There is no "air" "outside" to exchange. We have to refresh our air "in place." NASA has already done considerable research with plants that are especially effective as air-scrubbers and eaters of airborne pollutants.

2. In the course of everyday life, not all settlers will spend time in or passing through the agricultural areas. Knowing that out-vac, out the air locks, there is only vacuum and sterilizing UV and cosmic rays, abundant foliage in the homestead where everyone will come into daily contact with it, will reassure us all that we have indeed brought along a pocket of life-encradling Mother Nature, a patch of Old Earth. The home garden will be a psychological security blanket as well as a "feast for sore eyes." Air freshened by plants is not only fresh, but fragrant.
3. Reliance on settlement-wide systems, will share both benefits and risks. Supplementing settlement air and water recycling / refreshing utilities with in house systems provides risk-distributing backup.
4. Homestead gardens can be integrally linked to human waste pretreatment systems, greatly reducing the burden to be handled by settlement-wide utilities. The Bill Wolverton system is very promising in this regard. Read: <http://www.wolvertonenvironmental.com/dww.htm> By treating 95% of the problem at its source, the settlement biosphere can grow in modular fashion instead of as a megasystem much less adequately buffered and much more prone to failure.
5. Without the multi-shade greens of the garden, without the bright colors of blossoms, flowers, and fruit, the gray (or ruddy) monochrome color schemes enforced by available building materials will become dreadfully dreary. The home garden will provide an ever changing feast of eye candy.
5. Sunlight, filtered to remove unneeded heat from the infrared, flooding the garden area will spill beyond its confines to flood adjacent areas of the homestead. We all know how important sunshine can be for morale -- even if it alternates 2 weeks on 2 weeks off with artificial grow-lighting.

And, in fact, there is at least one more good reason. The homestead garden promises to be an especially prolific incubator of frontier "cottage industries". More about that in the follow-on article.

How do we provide for home interior gardens?

To have a garden in a habitat pressurized against the exterior vacuum and thermal extremes, we need to provide water and light. For the sake of argument, we accept the statements that hydroponics are much more efficient than soil-based geponic systems, and that blue and red LEDs are much more efficient than sunlight. That may indeed prove to be the way to go in the community agricultural units, at least for some crops which do especially well in hydroponic growing conditions. (We are unconvinced that all or most crops do better with hydroponics.)

Soil-based horticulture on the Moon is quite feasible. In the process of handling the raw regolith, there is opportunity to sift out the powdery fines that could clog drainage systems, and to transform many of the regolith minerals into zeolites by baking. All this experimentation has been done and is well documented. Plus the regolith has many of the nutrients that would be needed, without resort to wholesale importation from Earth. Desired organic content can come from in home pretreatment of human wastes and composting of kitchen scraps.

Sunlight delivers too much heat, yes, but that can be filtered out easily enough. Or sunlight can be used to generate electricity to run full-spectrum lamps that are designed to produce reduced heat.

The biggest argument of all is esthetics. If any reader has heard of a garden show that attracted throngs of people by its beauty, in which all the plants were grown hydroponically and shown under banks of LEDs, my conviction might be shaken a bit. We have thousands of years of conditioning of our sense of beauty by soil-based gardens.

If soil-based horticulture is somewhat less efficient, that is immaterial. It has already been granted for the sake of argument that all the required nutritional needs for full dietary balance will be provided by settlement farms. Home gardens will provide surplus and to provide treats not planted in the settlement farms. The exchange of some degree of efficiency for much more beauty and satisfaction is a fair trade.

Architectural Provisions

How can the frontier architect, working with pressurized structures and locally produced building materials, design in sunlit garden spaces? Once one is convinced of all that is to be gained by having "Earth-patches" and how much is to be lost by not designing for them, this will not be seen as a design burden, but as a design delight. It will be a chance for the frontier architect to be creative, much as they are with churches. While form follows function, that is not a 1:1 determination. Architects will find many ways, some better, some cheaper, some more satisfying. Variety is the spice of life.

We have suggested a number of ideas in past issues for modular homestead layouts in which sunlit garden spaces were a key element. Below are a few.

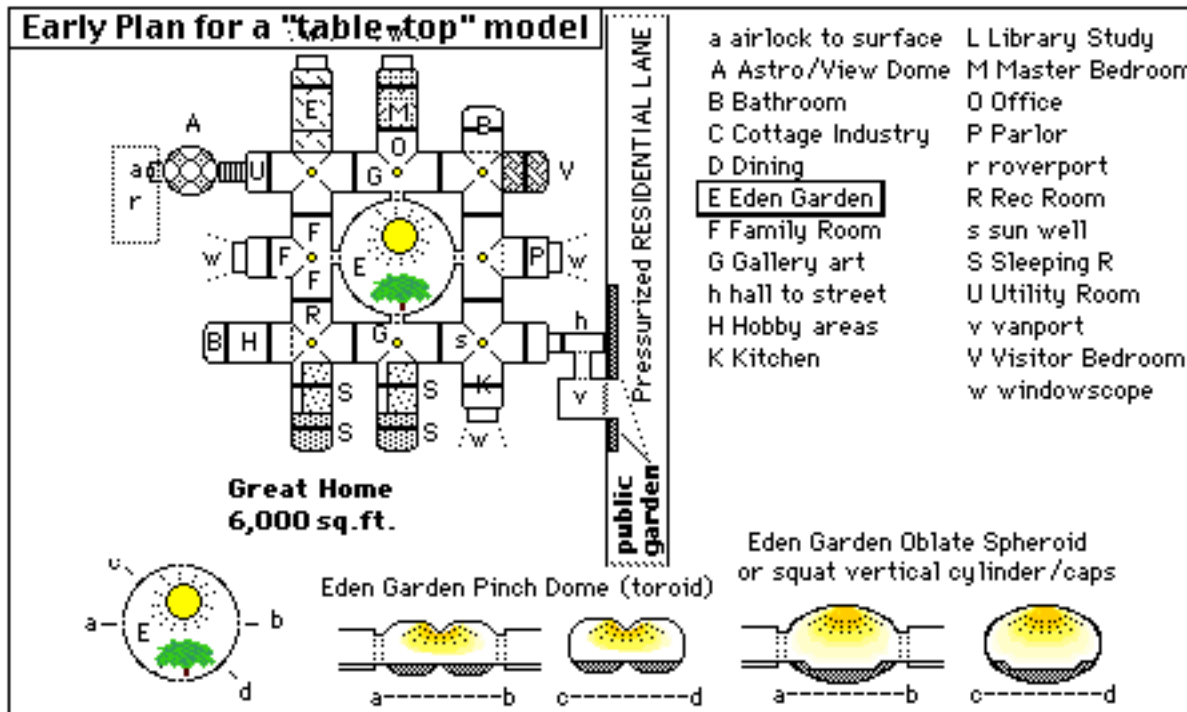
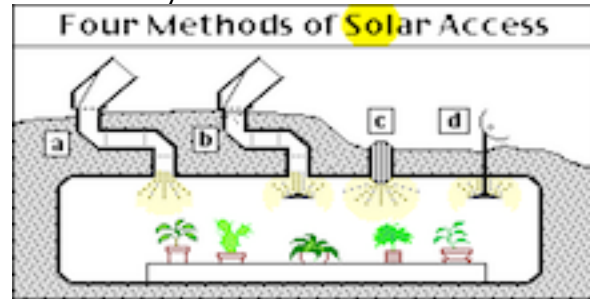

There are many architectural solutions for this concept, and it is not our purpose to pick any one but simply to help the reader visualize some of the possibilities.

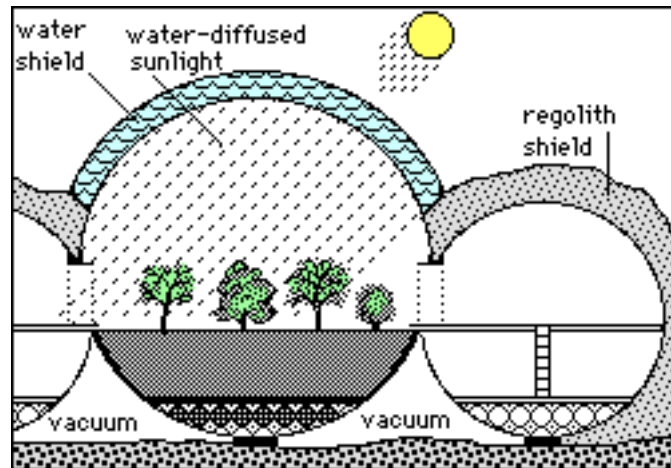
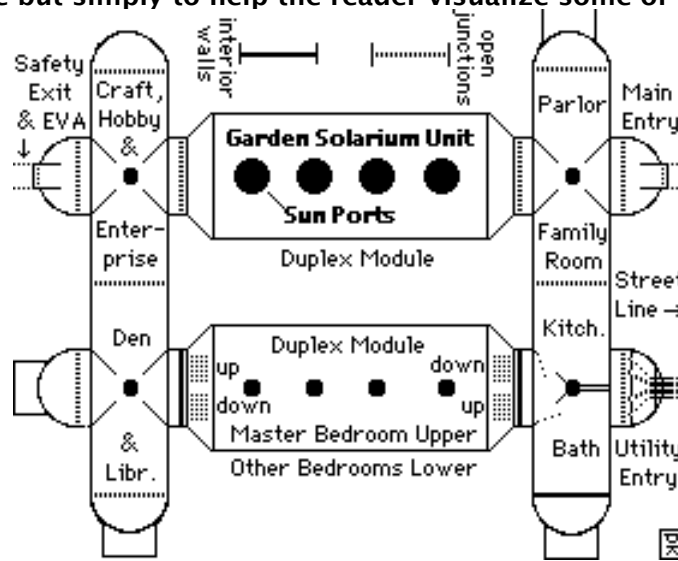

One interesting architectural allusion to some familiar terrestrial homes would be a frontier homestead built on the atrium garden courtyard plan with the living areas surrounding and opening onto a central garden area. Realizing that concept with modular construction methods in locally produced building materials is the challenge we put to would-be lunar architects. There is too much to be gained from realization of this idea to let initial difficulties stand in the way. It will be done sooner or later.

Extending Garden Spots throughout the Home

Solar access can be arranged not just for the central garden area, but throughout the homestead, delivered from central access ports through light tubes to areas above planters as well as areas needing accent or task lighting. Thus there could be islets of greenery wherever one wanted to have them. We might want planters, not lamps, in front of "windows"

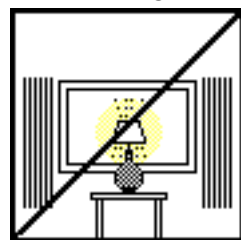

out with
one cliché
in with
another



Be they "periscopic" units or live video screens – to act as reassuring living “filters” through which to view the magnificent but chillingly barren planetscapes beyond. Light pipe ports could funnel in sunlight.

Using light pipe layouts to channel sunlight during the long dayspan and light from central sulfur bulb megalamps during the two week long nightspan, we can place planters, brimming with foliage and flowers, wherever we want them: along sidewalls, in the middle of large rooms, in sweeping curves or simple straight lines. Thus sunlit planters would be an especially great way to divide large spaces into cozy room settings. The pools of light would tend to visually obscure what lays behind them, making a virtual visual “wall” between areas with different functions.

How flexible would such a biological room divider system be? In other words, would the light pipe system and its ports be “rearrangeable?” After all, there are those homemaker types who quickly get bored with any given furniture arrangement, no matter how well it is tailored to the living space shell (walls, doors, windows, fireplaces and other immovable particulars.)

Given that light pipe systems would likely be installed only with customer involvement in placement of runs and location of ports (light fixtures), it is most likely that they will consist of modular components. If so, it is probable that they can be rearranged. At the most, it might involve ordering a few more modular connectors etc. However, pointable “spots” from a center ceiling-mounted pipe run should do the trick of channelling the dayspan sunshine (or nightspan substitute) wherever desired.

However, to the extent that some light access components are likely to be built into the various habitat modules, those would be more or less fixed. “Use them or lose them.” These features would include the sunlight point of entry “sundows” of various designs. [See the illustration “Four Methods of Solar Access” at the top of page 4, Col. B]

Another built-in lighting fixture is likely to be covers to hide ceiling washer lights -- of little use to a plant lighting system anyway.

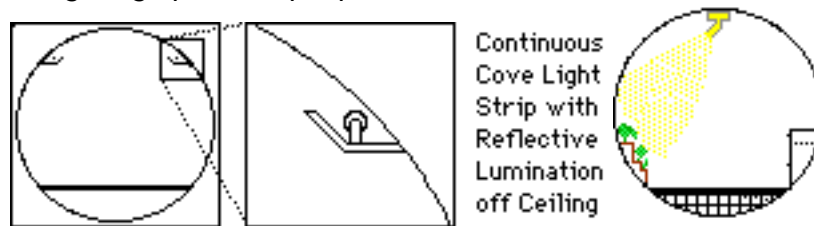

From MMM #75: “Lunar Appropriate Modular Architecture

hanging ivy, cactus collections, even bonsai “forests.” These terraces need not be geometrically regular. Freeform ones would be more nature-like and could even include mini-waterfalls. The illustration above shows a such garden side-wall terraces on the left, opposite built-in cabinets on the right, neither infringing on walkings space.

Streetside Gardening Opportunities

Our homes are usually set on lots with front, rear and side “yards” covered with grass, shrubery, flowers etc. On the Moon or Mars “lots” are barren and lifeless and without access to water or useful air. The “front yard” and “garden” has to be interiorized, located in the “reclaimed” space within the pressure hull complex. This “reclamation” process allows us to create “Earthpatches” in these unlikely settings.

Homesteads will not exist in mutual isolation but be interconnected in a larger biospheric maze, each opening via a securable pressure door onto a pressurized “street” on the analogy of our terrestrial residential blocks. If these streets are sunlit at intervals, then these frontages are also oppotunities for gardening – in public view.

Connecting Indoors and “Outdoors”

On Earth, a few older homes and many new ones, are specially designed “to bring the outdoors inside.” This is done with generous windows and window walls and patio doors. Outdoor plants seem visually connected to indoor ones. Using the same floor material on an outdoor patio as in the inside room opening onto the patio strengthens the illusion.

On the Moon where the “outdoors” strictly speaking is barren, lifeless vacuum -- the “Out-Vac” -- such a scheme is not possible. There is no vegetation outside the window and windows cannot be anywhere near as ample to keep depressurization risk at bay. But we can still establish a “connection.” Japanese style sand and rock plantless “gardens” are a model. Lunan homesteaders can place areas of bare regolith and lunar breccia rock, artfully arranged, in front of window areas, and fringe them with plants. This would “safely” invite the “Out-Vac” inside.

NOTE: not only would the regolith to be brought inside first be sifted to remove the ultrafine and troublesome “powder” but the remaining regolith “sand” would also need to be magnet-purged of as much of the free iron fines content as practical. These fines have kept their “virginity” as far as contact with moisture is concerned, intact for eons. Once in a pressurized and humid environment, they would rust. The graytones of the regolith would start to take on rusty hues. And that would destroy any illusion of an “indoors-outdoors” connection.

Options for Lunar Apartment Living

Homestead Gardens will have their counterpart in multiunit housing commons, with resident associations taking care of maintenance and upkeep.

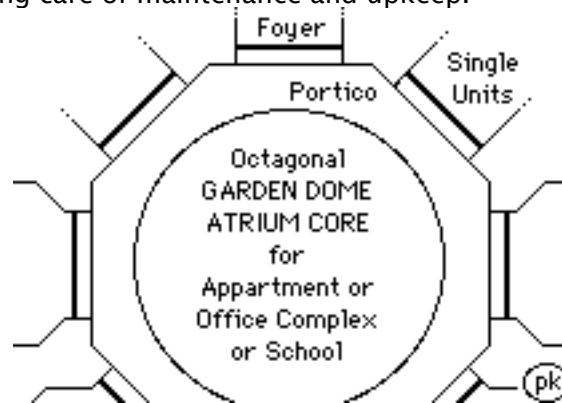

Water for the Gardens and Planters

Gardens require water, but not necessarily “extra” water. There is no reason why the water to be used in the gardens and planters, even in fountains and waterfalls, can’t be wastewater in some stage of treatment. Indeed, some interior plant beds can be integral to systems that provide primary treatment for human wastes, both liquid and solid. Bill Wolverton, a retired NASA environmental engineer has had such a system running trouble-free in his Houston home for decades. Not only is it surprisingly odor free and pathogen-free, but the air within his home is always fresh and sweet. We’ve written about his system before in MMM #116 July ‘98, “A Modular Approach to Biospherics” and incorporated a representation of it in our table top Moonbase. [See the link on page 5 col. A.] Read about Wolverton’s work at:

<http://www.wolvertonenvironmental.com/dww.htm>

He has published a book, “**Growing Clean Water,**” which joins his earlier work, “**How to Grow Fresh Air.**”

On Earth, every pound of living human flesh depends upon hundreds of pounds (or tons) of plant matter, every pound of which is supported by many tons of water -- consider the oceans! On the Moon it would be foolhardy to depend on marginal quantities of water. Even with conservative practices in both industry and agriculture and domestic use, we are going to need a lot of water. But we can stretch water much much further if we put it to work at every stage of its recycling loop.

Given these considerations, and the wisdom of building homes with integral primary waste water treatment systems, means that ample water for domestic garden spaces will be available -- must be made available. The “Earthpatch” concept is not only doable, but a must from several points of view: overall waste water and stale air treatment strategies, psychological health of the pioneer population, and opportunities to raise vegetables, herbs, spices, dye stuff plants, and flowers not included in the community gardens and agricultural areas. In a future

article, we will explore how homestead gardening can be the foundation of a versatile, varied, and thriving “Cottage Industry.”

Summing up

Quite by serendipity, it came to my attention recently that the Japanese word for “home” when written in the older Chinese character, is rendered by a compound character with one part being the character for “house” and the other “garden.” I suggest that the Japanese have it right. A house without a garden, inside and/or outside, may be a cozy house, but it just isn’t quite a “home.”

On Earth, the biosphere is a planet-wide given. We can get away with “ignoring” it in designing, building, and furnishing our homes. The biosphere will coddle us whether we make an effort to “integrate” our homes with it or not.

On the Moon, even on Mars, there is no given biosphere. In each settlement, all habitable spaces and structures will share a pressurized “safe house” and a shared mini-biosphere nourished within it. That human-installed biosphere will always be at risk. Partially distributing the happy task of maintaining it by the modular approach to biospherics that incorporates an “Earthpatch” and primary waste water treatment system in every living quarters is a strategy that makes sense.

On the frontier, we will have to “interiorize” the biosphere. That needs to become not only public, communal practice, but also “second nature” for each pioneer individual. With this approach, frontier children will grow up with “the biosphere instinct” and be green-conscious, freshwater conscious, fresh air-conscious. It is hard to see how frontier settlements can survive long term without establishing such a “culture” of greening wherever possible.

To be honest, not all of us (myself sadly included) have “green thumbs.” But that may be less a case of inborn talent than of how we were individually raised. Started early, most children can learn how to care for plants, and learn to enjoy doing so.

“Patches of old Earth” will be welcome everywhere, but “Reclamation Starts at Home.”

<MMM>

MMM # 149 October 2001



Goodies from Homestead Gardens

What do fruit jellies and preserves, deserts with special ingredients, herbal teas, specialty wines, organic dye stuffs, specialty house plants, craft papers, gift items, and family morale have in common? They are all possible products of space frontier homestead gardens pursued as cottage industry enterprises. More, below.

Homestead  **gardens**
& Early Cottage **Industries**

HOMESTEAD GARDENS & EARLY COTTAGE INDUSTRIES By Peter Kokh

Revisiting our Assumptions

This month we want to delve into the economic benefits of equipping lunar homesteads with garden spaces. But first, let's revisit our assumptions.

The common expectation that the first people to return to the Moon will be living in very spartan and cramped quarters is most probably right. Habitat space will be brought up from Earth, sized to fit either the Shuttle payload bay or top-mount fairings of big boosters. We could sneak in some elbow room via telescoping modules or rigid-inflatable hybrids of the TransHab or Moonbagel types. But chances are that extra elbow room would be used for operations, lab-space, storage, and other non private purposes.

It will only be once we have mastered the many tricks of handling mischievous lunar regolith and processing it into suitable building materials and coming up with modular architectures that permit fast, manpower-light construction with quick occupancy that personal quarters will start becoming more truly livable on a rest-of-one's life basis.

Once we reach this threshold of learning how to live off the land, the holy grail of lunar construction will become "spaciousness". Here on Earth, we can tolerate closer quarters when need be because we can go "outside" if needed to get relief from interpersonal pressures. Walk out the door and go for a walk, putter around in the garage, do some gardening. On the Moon, all our getaway relief spaces will have to be in pressurized structures. If we want a garden, be it for growing food or just for enjoyment, that garden has to be "indoors" and lit either by artificial light or by channeled sunlight, or both.

Last month, we talked about the "Earthpatch" or "patch of Old Earth" atrium garden space as the heart of the lunar homestead. It will take a while to get to that point, But make no mistake, if we do not reach that stage of "gracious living" in due course, the prospects for permanent, healthy human civilization on the Moon are not good. Hardships that are endurable on a short term basis become unbearable if there is no real hope of ever getting past them.

A garden is what one makes of it

Not every homesteading family on the Moon who gets to move into a new modular home equipped with an atrium garden space is going to want to be growing fruit, vegetables, herbs, and spices. Many, no doubt, will be quite content to enjoy relatively carefree greenery and some perennial flowers, perhaps. (and why not songbirds?) Even purely ornamental gardens will serve the essential purpose of producing sweet fresh air and pretreating waste water.

Some, however, will be anxious to try their hands at growing vegetables and fruits not planted in the settlement farms, in search of a more interesting diet and more varied menu choices. Among these will be some "green thumb" types who are good at it, good enough to produce surpluses worth selling to others as raw fresh produce, canned goods and preserves, juices and ciders, or other garden byproducts.

So while the original dual purpose of having an "Earthpatch" is to provide healthier homes and citizens with higher morale on the one hand, and to ensure that each home functions as a modular organic cell of the settlement biosphere at large, for some, these homestead gardens, "yours to do with as you please", will become a real foot in the door for off-hours and weekends "cottage industry."

Cottage industries enrich the lives of those who engage in them, provide the benefits of harvest to themselves, and by sale or trade (barter) enrich the lives of others. They also provide real personal satisfaction that may be lacking in their "day jobs."

Roots of Opportunity: the Quest for Variety

The settlement agricultural areas are likely to take a minimalist approach: providing a balanced diet in as efficient a method possible. That is likely to involve a relatively short list of basic crop "staples." While these staples will provide for all nutritional needs for the body, we all know that there is much more than that to human eating patterns, and there always has been. Food has to be more than nutritious. We want it to be tasty, and reasonably varied. But at first, providing for varied, interesting menu options and "cuisines" will rank as secondary.

This understandable priority will leave many pioneers wanting more, and wanting it badly. Of all the pleasures we humans enjoy, the most regular and most consistently valued, is

good tasty food with plenty of variety. The vacuum left by the short “basic” list will create an insistent demand which will surely intensify over time. Yet importing treats and specialties will be prohibitive. But we can expect to see some freeze dried specialties make it to the tables of pioneers for special occasions and holidays.

Given this situation, anything for which there is demand but is not grown in settlement agripod units, will lure would be entrepreneurial gardeners provided with a gardenable plot. This will include more fruits, additional vegetables, herbs, spices and seasonings, and beverage stuffs. The shortcomings of the settlement food production system will, in effect, create a vacuum. Nature, including human nature, abhors a vacuum. The appetite for more will become a necessity that will nourish a lot of inventiveness.

Only one “climate” may be supported within the farms: tropical, subtropical, or temperate. Any of these choices will rule out many crops favorites. If it is possible to support special climates within homestead gardens, one could cultivate items in demand.

To be honest, it may be easier to raise strawberries and other northern food plants that require frost cycles in large separate agripods than in homestead gardens that are integral to living space. But given the incentive, we doubt it would be impossible.

Yet another factor motivating home pocket farming is that some who seek assignment to the farms may be attached to farming or gardening methods that can’t or won’t be practiced there. The settlement farms may be largely hydroponic, for example. In that case, the homestead garden could provide an outlet for those rooted in the soil.

The Market for Home Processed Food Items

The settlement farms may provide only “raw” produce. It is more likely, however, that in order not to waste fruits and vegetables with low “shelf appeal” yet perfectly nutritious and tasty, that basic “canned goods” items and other lightly processed staples will be available, and sought after. That will still leave a lot of room for specialty products, especially as herbs, spices, and seasonings become available. Thus some homestead gardeners may well concentrate exclusively on raising such taste enhancers to add to store-bought staples in canning homemade taste enhanced labels at premium prices.

We can expect special marketplaces to spring where would look for such specialty items (as well as home produced arts and crafts, and other cottage industry items). Cottage industries of all kinds will seek to fill the shortcomings of settlement stores.

Resources for Homestead Gardeners

Where would homestead gardeners get seeds and seedlings, soil additions, tools, special processing equipment and other things required to support this kind of in-home light industry? Keep in mind that while the settlement fathers may need to concentrate on a few basic crop staples, it is still in every-one’s interest that enterprise-grown supplements to this minimal fare be supported and encouraged. It should be settlement policy to provide a varied seed “bank” and provide needed tools – even importing such items until they can be manufactured locally.

Seeds, seedlings, and shoots may be available even for non-food or food ingredient plant varieties. Increasing biodiversity within the settlement should be a major goal in its own right. So it would not be surprising if even those gardeners who are interested only in purely ornamental plants and flowers find official support and encouragement.

Cottage industry, however modest at first, is a primary pathway to economic diversification of the settlement. At first such efforts may arise mainly to fill local pent-up pioneer needs. But in time, many such enterprises could expand beyond their humble homestead beginnings to become major day job operations producing products for export. Keep in mind that anything produced on the Moon could likely be supplied to other off-Earth markets, such as tourist meccas in low-Earth-orbit, at a real cost advantage over equivalent products shipped up the steep gravity well from Earth’s surface.

In the U.S. most state universities with agriculture departments have “Extension” programs supporting agriculture and horticulture. Even in its earliest phase, any Luna University should have such an Extension service, as well as support services for home industry entrepreneurs in general. Again, both biological and economic diversification should be the goals of such an institution. Here on Earth, many universities and colleges do see enterprise support as a core function right alongside education and research. Indeed, such support efforts follow from research quite logically.

Even prior to the opening of a “university,” a Settlement Economic Development Office should foster such efforts. Given this favorable environment, it is likely that import of requested specialty seeds might be subsidized by the settlement government. The lunar settlement may start as a government-major industry consortium. But human society will not truly be transplanted to the Moon or elsewhere until free spontaneous private enterprise on all scales becomes a co-equal sector of the economy.

We have already seen [in the “Earthpatch” article last issue, and this month’s In Focus essay] that even if cottage industry products were not at stake, decentralizing biosphere maintenance is. By supplementing settlement farms and community parks with homestead gardens integrated with point of origin primary waste treatment, we provide a much more flexible, varied, and buffered biosphere life support base. And that translates to security, morale, and long term viability.

Gardening & Food Processing Coops

Okay, you buy all this, but ...! How can a family garden in a small plot that can probably not be expanded, sustain any kind of economically viable food product operation? The scale is just too small.

We agree. In all but very special cases, this does not seem to be a viable way to proceed. But why assume that each family has to operate in isolation and self-sufficiently? On Earth, where family farming with much larger areas under cultivation has become economically untenable, giant corporate farming has made major inroads. But there is another option, and one that has been successful in many fields: dairy, livestock, as well as crop farming. We are talking about coops co-owned by farm families.

Let’s say you have identified a market for raspberries, not grown in the settlement farms. Other families could join you to raise raspberry bushes on staggered harvest cycles. Together you could market them as fresh produce and even down the road invest in processing operations outside homestead settings. The tested coop model may work on the Moon as well.

Now of course, this sort of coop-supported activity becomes more realistic as the population of the settlement rises. The amount of such endeavor is likely to grow exponentially as the population soars past a hundred to a thousand, ten thousand, and ... It is a commonplace that beginnings are very humble, and in retrospect, even invisible, unrecognizable, and untraceable. Still it is possible for just one family to break the ice and demonstrate the cottage industry path to adding new items to the diet.

It could well be that the settlement fathers will stick to their plan in producing only absolutely necessary basics in the communal farms, turning a deaf ear to those clamoring for coffee, tea, chocolate, wine, beers and other semi-addictive nonessentials. It may be left up to garden coops to take the plunge in such areas, and they will find a supportive market, no matter how inferior their initial products.

Once the first homestead garden coop appears others will quickly follow. New fruits, vegetables, herbs and spices will become available in Gardeners’ Markets. Premium lines of canned goods and new processed food items like fruit and vegetable juice cocktails will follow. Coops could produce partially processed recipe makers such as gravies and sauces, soups, condiments. They could also market compost, seeds and shoots, house plants and much more. Thus diversifying the menu and supporting more interesting cuisines for family home cooking as well as for restaurateurs will be just the first area of home garden supported cottage industry.

As versatile food crops increase in number, a wide range of interesting eateries will appear. That can only help the Earth tourist trade and intersettlement tourism as well. The tantalizing aromas and odors associated with these new restaurants will soon become taken for granted. Of course, the first of these eating establishments may well be coop-owned.

Coops will give birth to trade magazines (the “Mother Moon News” and the “Earthpatch Farmer”) and offer basic and advanced courses in home gardening. They could organize home garden shows and cook-off competitions such as an annual “Taste of Luna City” event. Coops could conduct fundraising tours of outstanding home gardens, even contract with tourist companies for some gardens to be on one of the regular tour extension circuits.

All such public exposure will surely work to increase the percentage of homestead gardeners engaged in “production.” Enterprising individuals in other talent areas will be inspired to follow the cottage industry and coop trail. The excitement of helping build a new civilization will spill over to other areas of the economy. Enthusiasm is contagious

The lesson here is that by bringing together different areas of expertise, by marshaling real economies of scale, and by joint processing and marketing, the coop can combine the seemingly insignificant energies and abilities of individual home gardeners into products and activities that will make a real improvement in the daily lives of most settlers. It will be an improvement that just may tip the scales for many of those weighing the merits of returning to Earth or committing to life on the Moon indefinitely. Perks will be crucially important in creating a population that considers itself truly at home on the Moon. Coop-produced perks can help immensely.

Enter the Realm of Plant Byproducts

Homestead Garden enterprises can be aimed at other than the food, seasonings, and beverage markets. Plants are the source of fiber, with which to make rope, fabric, and paper. They are the source of natural organic dye stuffs like henna and indigo and many others. They exude resins useful in various ways and fragrances. Some plants produce substances of medical and pharmaceutical usefulness.

Gardeners could cultivate plant species as a source of any of the above, harvesting the plants for further processing in coop owned facilities. They might want some of the processed pulp, dyes, and other extracts to use for homestead produced arts and crafts and other uses. There is no one fast model.

Wood is not a likely product of homestead gardens. Hard wood suitable for carving into jewelry value items (on the Moon, wood would be that rare) is more likely to come from fruit trees grown in the settlement orchards – apple, cherry, pear, pecan and others. Some of that wood could support cottage artisans making small but valued keepsakes and high-end cabinet hardware (knobs and pulls).

Pulp for home-crafted paper can come from the stems of many plants otherwise destined for the compost piles or biodigesters. Such papers can be turned into gifts or greeting cards by family artists. Some would be sold at the Gardeners’ Markets for others to do likewise.

Temporary art (art du jour) materials both for children to use to develop their abilities of creative expression and for short term advertising needs can use dried leaves, corn cobs, dried beans and seeds and other items from the farms. Additional “special” items from home gardens may carve a niche here.

Even byproducts that represent but a small fraction of the total garden plant biomass might prove worth pursuing given that the remainder can find some use as fodder, mulch, compost or simply raw material for the biodigesters producing tofu-like supplemental food products. Such biodigesters will even make cotton raising reasonable.

Servicing the Home Garden Market

In addition to activities engaged in by coops, a number of enterprises might pop up to serve the horticulture market. Some of these services may be developed by homestead gardeners themselves out of necessity. After all, anything one succeeds in doing well for oneself is worth marketing to others.

But those not engaged in horticulture directly may have also applicable expertise, gained from servicing utility systems, manufacturers, and other sectors of the economy. Where there is a need to be filled and a buck to be made by filling it, someone will surely rise to the occasion. In the settlement's early days, many of these needs may go unfilled, and gardeners will find less help. But as the settlement population grows ever larger, the more certain that any identified or perceived vacuums will be filled.

- composting service & equipment
- installers of "water features"
- lighting systems
- automated systems
- marketing consultants
- garden doctors and consultants
- pollinators and pollination services
- networking clearing houses
- canning & pickling supplies: jars, lids, labels
- water handling systems: pumps, filters
- fertilizers and nutrient suppliers
- thermal management & climate control
- software programs
- packaging consultants
- garden planners and "architects"
- recipe makers
- restaurant suppliers

The Bottom Line for the Settlement

Lunar frontier pioneers will not enjoy the immense variety of domestic and imported products to which we are so accustomed here on Earth. The costs of transporting any goods or products, tools or parts not absolutely necessary up through Earth's gravity well will mean that the settlers will be largely left to their own ingenuity and creative enterprise if they want to supplement the spartan "issue" items regularly imported. This is true not just for food, but for apparel, furnishings, and entertainment and hobby items. In each of these areas, ingredients produced in home cottage industry gardens will play some role in the campaign to provide the variety that is the spice of life.

Widespread homestead vegetable gardening will create a decentralized Food Growing System to supplement the settlement's farming operations. This will promote the settlers ability to survive blight, plant disease, and crop failure emergencies.

In all these ways then – biological diversity, biosphere decentralization, point-source waste treatment, support of more diversified menus and special cuisines, art and craft materials, apparel choices, art du jour stuffs, even alternative nutrition supplements homestead gardens will be a major player in the transformation of our "intentions" to remain on the Moon indefinitely into genuine viability.

But it is the contribution of cottage industry that to us seems the most important consideration. From the outset, the lunar settlements will be hard pressed to reach the economic breakeven point that will turn them from tentative ventures into outposts of humanity that are truly "established." Garden-based cottage industry will play a significant role in diversifying the economy and intersettlement trade.

Breakeven point will be reached when the total value of items produced on the Moon for export sustainably exceeds the value of items that must still be imported both to maintain the settlement and fuel its continued growth. The struggle to reach that point will govern everything, underpin everything.

That strong all-transcending priority means that all "day jobs" will need to be either directly or indirectly supportive of production for export. In other words, we will need all able-bodied or able-handed personnel to be so involved. Vital "indirect" support will be provided by agriculture, utilities, and domestic market manufacturing products needed to sustain a growing local populace.

This does not mean that there is no room for economic activity aimed at filling "non-essential" and discretionary needs of people in search of the good life and greater comfort. It is the fact that people do not live by bread alone, no matter how nutritious (both these terms used both literally and metaphorically), that will motivate some more talented and more enterprising

pioneers to use their off-hours to produce things that will feed the need for taste, variety, and a richer life.

Once the settlement has established itself and seems to be a sustainably viable partner in a Greater Earth economic market, we will see these off hour economic activities emerge into the mainstream. That is, people will engage in meeting these good life needs of their fellow settlers on a full time basis. The domestic market will emerge as the primary market in the economy, with export/import activity assuming the supporting role. When that happens, the settlement will “have made it.”

Not by good food alone ...

The homestead garden is but one of several cottage industry enablers. We plan to talk about other likely fountainheads of cottage industry in future articles. As these humble beginnings begin to produce items that can be exported to help tilt the settlement's economic equation, some of these humble “cottage” industries will evolve into main sector day job industries employing many new settlers.

On the Moon, we'll be behind the proverbial eight ball. We'll need to work every angle.

<MMM>

Back Reading

MMM #2 FEB '87 “Moon Garden” MMM #39 OCT '90 “Saving Money on Food in Space”

MMM #148 September, 2001 “Earthpatch”

MMM # 150 November 2001

“At Home” on the Moon: No Longer Experiencing the Moon as “Alien”

By Peter Kokh

Our First Encounters with the Moon

While our Apollo astronauts were on their scientific picnics on the Moon, back in what's getting to be ancient history, “job one” was to protect them from “the hostile and alien conditions” of their temporary surroundings – “returning them to Earth safe and sound.” Their moonwalker space suits and their Lunar Excursion Module tent were designed to keep the Moon out, and Earth atmosphere and other “necessities” in. These precautions were totally understandable. We did not know for sure how benign or insidiously life-quenching the lunar environment might be. We were there to do science, not to make ourselves at home.

Lessons Learned

Thanks to these six excursions, we know that while the cosmic weather to which the lunar surface is exposed has potentially life-threatening hazards, there is nothing per se poisonous to us or plant life in the lunar regolith, however troublesome the fine powder fraction can be to housekeeping etc. The next humans to go to the Moon will have to take the cosmic ray and solar flare dangers of the lunar environment just as seriously as did their scouts. But armed with what they have learned, those returning to establish a beachhead will be there to learn how to engage the Moon and deal with it -- on its own terms.

They will be there to test and verify equipment and strategies that will enable them to remain on the Moon throughout the dayspan and into and through the nightspan. Our previous explorers had been on the Moon in “midmorning” conditions only.

They will be there to test equipment that will allow them to explore the regolith as a reservoir of potential resources: oxygen and various materials for fabricating useful products. “Pure” science will continue to be a mission goal, but from now on pure science will become secondary to practical applied science as the main goal. We will have returned to the Moon with the ultimate goal of becoming Lunans.

Becoming Lunans

That's a status that has to be earned. We will have to achieve a respectful intimacy with the Moon, combining a “second nature” awareness and responsiveness to the dangers our

chosen new homeland poses with engagement at every opportunity. We're sure some will be offended by the analogy but it is appropriate – we'll have to learn to enjoy “safe sex” with the Moon. How?

First we must become at home with the Moon's pulverized surface blanket – the “regolith”

- We have to practice “dust control” by 2nd nature
- We have to learn to do arts and crafts with regolith-derived media
- We have to learn to build living space out of regolith-derived materials

Not only must our engagement with the Moon show in our homesteads and how they are constructed and furnished, but we need reinvented “moonsuits” that will help our senses truly engage the Moon when we are out and about. And, we need Out-Vac sports and hobbies which allow us to enjoy being out on the “alien life-hostile” surface as well as in our comfortable homestead retreats.

In short, we must get past our defensiveness, not by ignoring the dangers and risks, but by learning how to deal with them as if by second nature, the way we in Wisconsin deal with the winter dangers that give sun-coddled southerners the dreads. It is only by such a degree of comfortable familiarity that we can go on to enjoy such a bogeyman climate: enjoying the beauty of fresh-fallen snow, the crunchy sound and feel of cold snow underfoot, the cold kiss of winter air on the cheeks, skiing, tobogganing, ice-skating and other winter sport pleasures. Knowledge and skill must replace paralyzing fear before we can truly enjoy. And the path that northerners and others who have settled in niches once deemed hostile by those in “more benign” homelands, is a cultural and psychological journey that Lunan pioneers and settlers will take as well.

For sure, Earthlubbers will always think of the Moon as a hostile, alien, impossible place. Their loss, our gain. The Moon is a frontier, no more, no less. Perhaps the most challenging yet. But who of us would be ready to change places with a polar Eskimo? The accommodation can be done. The acculturation will be made. And those who succeed in this process will learn to love their new adopted homeworld and pine not to return to Mother Earth.

This is a prediction we make based on some idea of the tremendous range of possibilities, of the potential of the Moon to serve our needs. But the conviction we have is based even more solidly on the nature of being human – adaptation is something we are extremely good at. We will do it because we can!

Cosmic rays, solar flares, intense raw ultraviolet, extreme heat and extreme cold, two week long dayspans and two week long nightspans, insidious moondust, dryness beyond that of baked concrete, the ever black sky, isolation from the immense diversity of Earth's consumer goods shopping heavens and the general unavailability of so much that those left behind take for granted, having to do without or make do with “inferior” substitutes, isolation in general, no nature-given biosphere to take for granted and to enjoy in shirtsleeves without breathing assists -- the sad litany goes on and on. Oh yes, one thing, the Lunan settlers will be anything but sad. They will have learned to love the Moon. It's a bet. <MMM>

Learning to Not Fear the Night

By Peter Kokh

My first response to a bloke who dismisses the Moon with “been there, done that” is to point out that we haven't been to the Moon “at night”, much less for “a single full night.” Like I've been to the middle of Siberia (Bratsk) -- but it was at the end of July and the beginning of August (1981) -- big deal!

You haven't been to a place, not really, until you've been through a whole cycle of seasons. On the Moon, the cycle of seasons and the cycle of day and night are pretty much one and the same, the 29.5 day long sunrise to sunrise or sunset to sunset cycle. When the sun comes up, it stays up for almost 15 days. When it sinks below the horizon, it stays out of sight for almost another 15 days. “Dayspan” and “Nightspan” are the terms we've been accustomed to using in MMM. Put them together and you have a Sunth, not a month -- the interval from

Sun up to Sun up, not from new moon to new moon. It's a matter of perspective: we're looking at it from the Moon's vantage point, not the Earth's.

The Apollo crews visited the Moon in the "mid morning" periods only. Not only did they not dare stay for the night, they fled before High Noon. If you are afraid to stay and experience the Moon full cycle, how dare you say, "been there, done that!"

Fear of the nightspan is rooted in two factors. It gets quite cold and solar power is unavailable. If all we are doing is pitching a tent – a Lunar Lander – the bitter cold may well be a problem. If we put up an outpost and shield it with regolith to protect from radiation, then we will also have buffered ourselves from both the extreme high noon heat and the post sunset extreme cold.

If we rely solely on direct solar, then power is a problem. But we can easily generate excess solar while the sun shines, storing reserves for nightspan use, as well as including backup nuclear power.

If we take the first "enhanced solar" route, we can meet any power deficit half way by planning our operations to concentrate on energy intensive tasks during the dayspan, reserving labor-intensive ones for the nightspan. In approaching the problem this way, we will set up a rhythm of life and operations that is one with the Moon's own rhythm. We will no longer fear the Night-span, because we will have faced it on the Moon's own terms. Nothing "alien" about it!

Relevant articles from MMM issues past:

#43 MAR '91 p. 4 "Dayspan"; "Nightspan" – p. 5 The "Sunth"

#90 NOV. '95, pp. 7–9 "Overnighting on the Moon"

#126 JUN '99, pp. 3–8 "Potentiation: a Strategy for Getting Through the Nightspan on the Moon's sown Terms"

#115 MAY. '98, p 8. High Noon: Coping with Dayspan Heat

<MMM>

Learning to Love Moondust: Domesticating the Regolith

By Peter Kokh

Effective Regolith Symbolism – Early Days

Be they on short-term tours of duty or the first prospective settlers, if everything around the pioneers has come from Earth, the Moon will remain cast as alien, as something from which we must keep ourselves safely apart. One way to break this psychological "quarantine" is to begin as early as possible to start making useful items or even merely decorative "accessories" from raw regolith.

Humble crude starter industries that should be in reach of early pioneers include:

- sintered metal products made out of pure unoxidized iron powder fines harvested from the moondust regolith with a magnet
- sinter-cast regolith items using microwaves or a crude solar furnace
- glass and cast basalt products made with a solar furnace
- crude ceramics

Additionally, larger moon rocks or "breccias", surface dust removed, can come inside, as is, or cut and polished to reveal hidden beauty inside. Regolith particles, sorted for color, would allow "Moonscape" "sand paintings" as are familiar in our Southwest.

Sculptures for wall or tabletop, useful items such as glass or ceramic tableware, planters and flower pots, napkin holders, and cast basalt table top slabs will all serve to "bring the regolith inside" in a safe way. This kind of simple, relatively easy blending of raw native lunar and made-on-Luna objects into a habitat setting made-on-Earth, pierces the veil of quarantine by showing that the stuff of the Moon is just as much a medium for human creativity and artistry as is the more familiar "earth" of Earth.

As such “made of moondust” artifacts become more sophisticated, they will find an export market both in other space locations such as LEO orbital Resort Hotels and space liners and on Earth itself.

Bringing the Outside In & the Inside Out

Especially and effectively symbolic would be indoor Japanese style gardens of “raked” moondust dotted with carefully placed moon boulders. First the fine and troublesome powder fraction can be sifted out of the regolith. Then any pure iron fines must be removed by a magnet, lest the regolith “rust” in contact with indoor humidity. These modifications are relatively easy to accomplish and leave the “domesticated” regolith looking very much as it did “out-vac” on the exposed surface.

Of course, it would be equally legitimate to let the unpurged regolith rust naturally. This would be a Moon-appropriate way of bringing in a range of familiar “earthtone” hues as relief from the gray monochromatic scheme of regolith *au naturelle*, and another way of “domesticating” it.

Another way to merge inside and outside is through the use of cast basalt pavers inside, and again outside on the approach to an airlock, for example. cast basalt floor tiles can sport the full range of regolith hues and variation and possibly even smoothed breccia inclusions as highlights (casting temperatures permitting) in random patterns. Cast basalt tiles are a known technology on which we reported in MMM # 135.

Other “interior” furnishings such as tables, benches, chairs made of lunar iron, cast basalt, lunar concrete, etc. could also adorn Out-Vac “patios” and walkways. Regolith domesticated for indoor uses could thus return transformed to the surface, reinforcing the mutual accommodation of Moon and Man.

On all new and strange frontiers past, people have first begun to make themselves at home by using local resources to meet some of their needs – indeed, as many of their needs as possible to an insistently resourceful spirit. This kind of artistic accommodation is a toe-in-the-water first step towards a much greater commitment to learn how to “live off the land” as thoroughly as possible. The artists, crafters and collectors will be the first pioneers to say with their proud achievements, “hey, we’re here! Might as well make ourselves at home for the duration!”

Longer term, Lunan artists, craftsmen, architects, furniture makers, and interior designers will be able to do much more by way of integrating lunar materials into their new homesteads so that the our settlements “grow out of the moonscape” so to speak. The Moon will have ceased to seem alien, because we will have learned enough of its secrets and ways to rely upon it for shelter and even our livelihood. Our point is rather that we can, and must, take humble but real steps in this direction from the very outset.

Food from Regolith?

Post Apollo agricultural experiments with returned moonrock samples showed not only that regolith is not toxic to plants, but that it contains useful nutrients and can be transformed into a superior rooting and growth medium. First the fine powder must be sifted out lest it clog the drainage systems. Then, as an improving option, the soil can be heated to 150°C which results in an appreciable fraction being transformed into zeolites that hold water-borne nutrients well. Treated human wastes and kitchen compost can be added. Nothing will exonerate the reputation of regolith more than using it in household flower and vegetable gardens that provide food, fiber, freshened air, and color. Hydroponic gardens might be easier to set up and maintain but they will require greater import of nutrients and be less “reassuring;” but to each, his own.

From Regolith, Lunar Architecture

The next stage will be to build expansion habitat space itself from regolith derived materials: lunar steel or other alloy, lunar concrete, glass-glass composites, etc. Each of these materials, each characteristically different from Made on Earth analogs, will bring a uniquely lunar quality and feel to the inside spaces they frame. In the process, homestead structures will

in a very real sense “grow out of the moondust,” further rooting their occupants to their new home world.

Even on the outside, the marriage of Moon and Man will be evident. There will be the tell-tale pattern of shielding mounds, lavatube entrances, and outside storage ramadas. Some homesteaders may choose optional “lithscaping” of their shielding mounds, with boulders and breccias, with ceramic and cast basalt shards, with coatings of lunar lime (calcium oxide), glass, etc. As the settlement ages, we can expect to see such attempts at refined sophistication, Moon-style.

We have also talked about lunar architectures that “take back the surface” in MMM #137. And in issues #55 & 111 we described lunar-appropriate “skyscrapers” which sprout out of the surface, breaking the horizons as if they belong, because they will. Unlike the first “outposts” which will be made on Earth and “dropped on the Moon,” future human settlements will be homegrown.

In short, the Moon is more than a location where we will settle. It is a location out of which settlements will grow. In such a mutually involving process, Lunans will hardly feel like “Strangers in a Strange Land.” They will feel at home, because they will be at home.

Relevant articles from MMM issues past:

#3 MAR '87, “MOON MALL”

#5 MAY '87, “LUNAR ARCHITECTURE”

#16 JUN '88 “GLASS GLASS COMPOSITES”

#55 MAY '92, p 5. “SKYSCRAPERS ON THE MOON?” p. 7 “MOON ROOFS”

#63 MAR '93 p. 5 “Sintered Iron from Powder” p. 8 “GLAX: glass-glass composites; GLASS”
p. 9 “Ceramics” p. 10 “Color the Moon Anything but Gray”

#74 APR '94, p. 5 “Lunan Homes; Shielding & Shelter”

#77 JUL '94, p 4 INSIDE Mare Manor: “Cinderella Style”; “FURNITURE”; p. 6 “SCULPTURE”

#89 OCT. '95, pp. 5-6. “Dust Control”*

#91 DEC. '95, p. 4 “Startup Lunar Industries”*

#111 DEC. '97, p. 4 “Lunar Skyscrapers: Shattering Low Expectations”

#135 MAY '00, p. 7. “Cast Basalt: Industry Perfect for a Startup Outpost”

#137 JUL '00, p. 5. “Take-Back-the-Surface Architectures”

<MMM>

“The human race shouldn't have all its eggs in one basket, or on one planet.

Let's hope we can avoid dropping the basket until we have spread the load.”

-- Stephen Hawking



Embracing the Moon's Rhythms – Adopting a Moon Calendar

By Peter Kokh

Living and Working by the “Sunth,” naturally

The slow two-week long crawl of the Sun across the black lunar skies would surely seem to merit the term “alien” along with the equally interminable wait for the Sun to rise again. Meanwhile, in all our activities, we will be in constant scrutinizing communications with Earth. At the beginning, the clock and calendar of our sponsor nation(s) will govern all activity schedules. Not so!

Many activities from field work to mining to energy production will necessarily be timed to the rhythm of local sunrise and sunset -- to the “sunth.” Now surely personnel on the Moon can observe such schedule constraints while continuing to use Earth's international calendar for all other purposes.

TERMS: the 29.5306 day long period from sunrise to sunrise at any spot on the Moon is called a lunation. By sunth is meant the equivalent length of time as reckoned from a set location, and as used as a calendar division of time.

But as temporary personnel on limited tours of duty are gradually phased out to be replaced by a growing number of volunteers willing to stay much longer, even indefinitely, the sense of adopting a truly lunar calendar will begin to become appealing. Most people prefer a predictable routine over the long term, however welcome occasional breaks may be. The plain fact is that the pace of the Sun, and whether or not it is currently dayspan or nightspan, will greatly affect the agenda for the (calendar) day for almost everyone, in most every occupation. If we had a calendar which enshrined this natural lunar rhythm cycle, it would regularize everything.

Reconciling the 24 hour day with the 708 hour long sunth will be the easy part. Lunans would simply alternate sunths of 29 and 30 days, adding a leap hour every 7 weeks or so for a longer night's sleep -- never a shorter one! Of course, that would mean a gradual drift off of whatever terrestrial time zone they had started with -- Houston's Central Time or London's Greenwich Mean Time (Universal Time, Zulu time.) That way they would just be "democratic," sharing clock time with one time zone after another.

The benefit of this observance of sunth time would be considerable. Local sunrise and sunset would occur on the same dates every sunth, give or take a half day depending on whether it is a 29-day or 30-day sunth. This means that work scheduling that depends entirely on the local day/night situation can be regularized from sunth to sunth. Life would take on a certain predictable rhythm. And most people do strongly prefer predictable rhythms.

Factoring in the "week"

One could go further if -- (shrieks of horror from Jewish, Christian and Islamic fundamentalists) settlers adopted a variable length week. **Five 7-day weeks with three interspersed 8-day weeks makes 59 days or two calendar sunths exactly.** That would put local sunrise and sunset regularly not only on the same date, but also on the same day of the week.

Firstsun (odd # sunths)							Secundsun (even # sunths)								
A	C	E	Ma	Me	S	T	P	A	C	E	Ma	Me	S	T	P
1	2	3	4	5	6	7		1	2	3	4	5	6	7	
8	9	10	11	12	13	14	15	8	9	10	11	12	13	14	15
16	17	18	19	20	21	22		16	17	18	19	20	21	22	
23	24	25	26	27	28	29		23	24	25	26	27	28	29	30

Would people accept this? Historically, the seven-day week has been the single most change-resistant timekeeping interval. But there are ways to compromise. The seven named days could remain, with the occasional intercalary eighth day occurring on the weekend, say between "Saturday" and "Sunday." There would be little resistance to nineteen 3-day weekends a year -- three 3-day weekends every two sunths! -- except by the business sector, of course. The extra day might even be adopted by religious leaders for scheduling seasonal feasts and other religious observances. This presumes some good will on the part of religious leaders and some willingness to adapt their schedule of religious feasts to the lunar calendar. Freedom means that some will simply govern everything by Earth calendars. So be it.

The Weekend

On Earth, many businesses must operate around-the-clock day in, day out -- "24/7." That means that work schedules are staggered or even put on a rotation of 6 or 8 days ("not 7") so that everyone takes his or her turn working weekends. On the Moon it will be even more

important to keep expensive capital equipment and expensive shared facilities such as schools and parks open and running all the time. So what is a true “weekend” for the largest number will surely not be so for all. How the settlers decide to “be fair” or “flexible” will be up to them.

The Weekdays

Now I put “Saturday” and “Sunday” in quotation marks for a reason. You see, the sticking point will be that in a system with periodic eight-day weeks, the named day of the week on the Moon cannot long remain the same as the universally named day of the week on Earth. With the very first 8-day week, the next lunar “Sunday” would fall on the next terrestrial Monday. In a little over two months, the days of the week would coincide again -- temporarily.

There can be only one way to avoid confusion:

The early pioneers must adopt a totally new set of names for the lunar days of the week, seven constant and one periodic. Now there is nothing very religious about the names of the days of the week in most modern languages. The days are named after the seven celestial bodies known to the ancients: Sun, Moon, Mars (Tiw), Mercury (Woden), Jupiter (Thor), Venus (Fria), and Saturn (in English using the Scandinavian equivalents given in parentheses.) So there should be nothing either sacrilegious or antireligious about adopting a totally new set, to avoid any confusion.

Fundamentalists, of course, believe that when it is Sunday on Earth it must be Sunday everywhere in the Universe, ignoring the fact that our 24 hour day may be peculiar to our home planet. In fact it can be Sunday one side of our International Date Line and either Saturday or Monday on the other side, and no one loses sleep over that. Avoiding confusion with Earth’s calendar will be essential, just as is avoiding confusion between Metric and English units of measurement. Some suggestions for day name sets of 7(8) names are given in the MMM #7 article cited below.

Sunths and Years do not neatly mix

So far so good. The real sticker comes if we attempt to assign a year number in a lunar calendar. One Earth year, and the Moon does share this once-around-the-Sun pacing, works out to twelve lunar months (sunths from a Lunan’s perspective) of 354 days plus eleven and a fraction days left over. That’s quite inconvenient, it would seem. In the Hebrew calendar, an adjustment is made by inserting a thirteenth month from time to time. In the Islamic calendar, there is no attempt to keep pace with the solar year count -- the year is counted as 354 days and so shifts constantly with respect to the seasons.

The Metonic Cycle to the rescue

However, there will only be a problem if the Lunans adopt an annually rotating set of sunth names. Happily, there is a way to avoid this. Just by chance, the lineup of sunth and month repeats every nineteen years in a pattern known as the Metonic cycle. In short, 235 “sunths” is very nearly 228 calendar months (a total deviation of only 2 hours!). Now if the Lunans simply numbered the sunths from 1-235 they could still observe the shared terrestrial year count.

There really is no other “elegant mathematical” solution. We’ve tried to brainstorm the problem in various directions for the past 15 years. Such a solution has been sought in vain by lunar calendar partisans for millennia.

Numbering the sunths from 1-235 with a repeat every nineteen years will work just fine. We could assign them short, easy to remember compound names, using the first syllable roots of the Latin names for the numbers 0-9: ni, un, du, tri, qua, qui, si, sep, oc, nov -- or some euphonic variation thereof.

Quioct = #58, Septri = #73, Novni = #90, Unquasi = #146, Dutriqui = #235 -- etc.

Starting Points

So where or when would we start counting? The answer is simple, on any nineteenth year in which our January first happened to coincide with a “new moon” or “full moon” -- whichever standard we wanted to adopt. When we see a full Moon, observers on the Moon

would see a new Earth (the night hemisphere of Earth would face the Moon.) When the Moon is “new,” the side facing Earth is totally dark and observers on the Moon would see a full Earth.

What would be the logical place to start a sunth from a lunar viewpoint? That depends on the chauvinism that comes with where on the Moon you happen to have settled. For Farsiders, any consideration of the “phase” of Earth would be moot -- Earth will never be above their horizons. Perhaps most settlers will live on Nearside where most of the mare plains are located.

Sunrise on the eastern limb (Mare Smythii – Mare Marginis – Mare Australe) at 90 °E would seem as good a starting point as any. That would coincide with “new moon” on Earth. If you wanted to mark the sunth from sunset at that point, the start of the sunth would coincide with what we experience as Full Moon. The settlers must make the decision, and pick up the sunth count reckoned back to the last new Moon or full Moon (whichever standard they pick) that occurred on a January 1st.

To follow or avoid Jewish or Islamic Practice?

Now in both lunar calendars in wide usage on Earth, the Jewish and the Islamic, the start of the month is reckoned from the first observable crescent moon, i.e. a couple of days after the new moon. The settlers can opt either to go with that precedent or break with it (by using the lunar standard suggested above) to avoid any confusion or appearance of religious considerations.

However, if they want a lunar calendar that is ready to go, has a fixed tradition of calculation, and still tries to keep apace with the year count, they could simply adopt the Jewish Calendar with or without its month names, and with or without its feasts and festivals. The one advantage of such a choice would be that calculators to translate Jewish and Gregorian dates into one another already exist, both on paper, and online. But similar calculators could easily be devised for any calendar setup the settlers choose to adopt. It’s only a software matter.

Calendars on the Wall

In plain practice, physical Lunan calendars would give the equivalent standard Earth date and day of the week (and/or day count #s 1–365) in fine print alongside the lunar sunth day number and day of the week name. It’s simply a layout problem, with a number of good solutions. One great advantage of the Sunth Calendar is that it won’t change every year. Lunar Calendars can be made of durable materials.

Relevant articles from MMM issues past: #7 JUL ‘87, “M” is for Month or “Sunth,” “Moon Calendar”

#43 MAR ‘91 “Dayspan,” “Nightspan,” The “Sunth” #92 FEB ‘96, p. 6 “Pioneer Holidays”

#95 MAY ‘96, p. 8 “Moon Calendar Revisited”

<MMM>

MMM # 151 – December 2001

Engaging the Surface with Moonsuits instead of Spacesuits “Mother Nature has a Dress Code!”

By Peter Kokh

In last month’s issue (MMM #150 NOV ‘01) we began our discussion of learning how to be “at home” on the Moon with articles on domesticating regolith, getting comfortable with overnighting, and learning to live with the Moon’s natural rhythms. But there is much more to this agenda, and we pick up the litany this month.

First on the list: lunar space suits!

Space Suits have traditionally been designed to protect us from alien environments, not to engage those environments on a “let’s make ourselves at home” basis. These would seem to

be just empty and cheap words at first reaction, but let's play with the idea, follow it, and see if it leads somewhere new.

When NASA sent astronauts to the Moon, it was with suits designed to protect them from a poorly understood and understandably "alien" environment. They did have a good understanding of the thermal loads and heat-management problem, of the radiation flux at the Moon's surface, and some inkling of the uncooperative character of the pervasive moon dust. In designing the suits, it was essential to err on the side of overprotection. After all, the scientific goals of these missions were definitely secondary to the overriding directive to "bring 'em back alive!"

When we return to the Moon, the controlling directive will be to learn how to stay. Breaking the systems engineering and psychological barriers of overnighing will be at the top of the list of milestones in this campaign. And that will mean that we must have suits that can do more than handle the moderate "midmorning" solar heating loads. They must be up to handling the higher heat loads of "high noon" and of the lunar "afternoon" period (remember that from sun up to sun down takes a full 14 and three quarter standard Earth days). But in order to do outside routine and emergency housekeeping, maintenance, and other chores during the equally long subbitter cold night spans, the suits must have a controllable heating capacity with high reliability. Proper insulation against heat loss by radiation to the black sky will be essential. So even without the extra features we will identify as desirable below, the suits for the return missions will have to be improved, at least in thermal management capacity, over those of the Apollo era.

So much for the obvious. What we want to talk about in this article is the need for Moon Suits that go beyond such improved basics. We need to put to work the tremendous electronic telesensing abilities that have become doable in the three decades since the Apollo feats.

Smart Suits

For safety' sake and to maximize the odds of safe return, or rescue if that should ever be necessary, we can build a number of sensors and computer processor chips into our new "smart" moonsuits. The wearer should have at his or her demand, all of the following kinds of vital information:

- Power reserves and time available at current energy consumption rates
- Oxygen reserves and time remaining at current consumption rates
- Thermal management stress loads as a function of capacity
- Radiation flux with screen becoming activated when flux exceeds normal range
- Built-in GPS (global positioning system) distance covered (GPS track) over the horizon landmark locator (GPS calculator) direct return route distance (GPS calculator)
- Warning when the capacity of any system approaches the "point of no return" level

The readouts from these devices could be either constantly visible, or projected on the visor "heads up" area either when activated by a voice command or automatically when a caution or emergency condition develops. No one needs to be unnecessarily distracted by boring confirmations

that everything is "functioning within normal parameters," but information that requires attention, must have a way to get attention. An alternative to a heads up display for less critical information would be a sleeve readout device.

A transponder belongs in every moonsuit. It could broadcast its signals via satellite or via a relay at one of the Lagrange point station (L1, L2, L4, L5 -- according to one's location on the Moon's surface). To personnel at the outpost or vehicle from which the suited excursion originated, the wearer's position would be monitored (as a backup system in addition to the suit's own GPS monitor.) If there was sign of inactivity lasting long enough to cause concern, or a cut off in transmission, or a signal that a suit function had failed or been compromised (e.g. even slow depressurization from suit puncture), the wearer's location would be pinpointed.

Additionally, if someone sensed s/he was in trouble, the whereabouts of any nearby persons also out on the surface could be ascertained, and a route to their location plotted or a signal sent.

One of the tradeoffs of such safety features is that if the Big Brother aspect. There are times when one may want to be alone -- just him/herself, the moonscapes, and his/her thoughts. One should be able to turnoff a transponder, but with a double switch to prevent accidental disconnects.

These kinds of "Guardian Angel" features are well within current technology limits. They would make us more safely "at home" on the Moon. There is more we can do, so stay tuned.

Smart Visors

Not only can we thus greatly improve moonsuit safety features as described above, we also have it within our power to greatly enhance the wearer's perception of his/her environment. In comparison to the "Native Scout" expert clue recognition abilities that moonsuit wearers will "put on" when they don their suits, the Apollo moonwalkers had all the clueless sensory capacity of city slicker dudes. No offense intended, of course! They were all genuine heroes of the first rank who did all they could and more with the tools we gave them.

Our point is that it is not enough just to be able to look through a helmet visor with the naked eye. Moonscape's are notoriously monochromatic and the immense information that they bear comes across to the naked eye as a monotonous blur of seemingly trivial details. Smart Visors and other electronic sensory enhancers could change all that, and allow the wearer to see an immense variety of significant information of scientific, prospecting, or other value that normally fades into the monochrome overload.

Smart Visors and other sensory enhancers will allow future moonwalkers to "engage" the Moon as never before, by letting them see and sense information clues that "naked eyesight" just can't detect, notice, or pick out. Here are just some of the possibilities that are within our means.

- infrared scanning of the ink black shadows and kneemount shadow penetrating spotlights
- phosphorescence sensors
- picking other humans out of the background
- exaggeration of slight and subtle color difference
- telescopic zoom-in capacity
- sensors that sniff any outgassing in the area
- range finder (distance to near horizon features can be greatly misjudged by the naked eye according to Apollo EVA experience)
- level horizon guide (in low gravity, one's ability to detect slight slopes is impaired)
- filters that enhance visibility through any dust electrostatically suspended over the surface
- alert-alarm and activation of laser spotlights when sensors in combination with expert recognition systems detect the special spectral and reflectivity signatures of minerals etc. on a field science or prospecting watch list
- alert alarms for any motion in the visual field
- alert alarms for any motion in the shadows
- other expert recognition programs
- major computing power to analyze inputs (the computer design should address the clumsy gloved fingers vs. keypad issue using voice recognition software and other means, be able to calculate mineral and element abundances of samples, and, using GPS and range-finding data draw simple but functional "map" guides)

We've probably missed a lot of other possibilities and if readers have some suggestions to add to this list they are encouraged to contact MMM by mail or by email

<KokhMMM@aol.com>

But the list above will give some indication of the enormous potential there is to use today's electronic wizardry to let future moonwalkers be vastly more attune with and aware of their environment. "Engaging the Moon on its own terms" is what we are after -- the ability to be able to see critical information normally lost in the visual monotony as if one were an experienced native-born scout.

Wearability and Mobility Issues

Comfort and Convenience were justifiably secondary concerns for the designers and fabricators of the Apollo moonsuits. One can put up with most anything on a temporary basis, so long as the discomfort or inconvenience is not great enough to compromise the work at hand. But now we are going back to the Moon, intending to stay, intending to make ourselves at home. Field scientists (geologists, mineralogists, etc.) and prospectors and others will be out on the surface for longer periods, and repeatedly. In such circumstances, discomfort and inconvenience risks compromising the work at hand.

What do we need here? Surely suits that are easy to put on and easy to take off without assistance. And suits that do not require pre-breathing special air mixtures. We need to make it so wearing proper apparel to go outside on the Moon is no more of a big deal than wearing proper apparel for rain, cold, wind, or snow is for us on Earth. In short we need suits that protect us without a lot of bother and drama.

We shouldn't attempt to find an ideal design that offers such features in isolation from the even more important issue of dust control. The use of conventional airlocks will inexorably lead to the in-migration of annoying and trouble making amounts of fine powdery moon dust into pressurized habitats, labs, workspaces, and other facilities. Previously we have proposed a solution prefigured in illustrations by the great lunar outpost illustrator, Pat Rawlings -- the clamshell-back or turtle-back spacesuit. We described its operation in the MMM #89 article cited at the bottom of this article.:

"Pat Rawlings who did the illustrations Ben Bova's 1989 book "Welcome to Moonbase" [Ballantine Books, New York, ISBN 0-345-32859-0] has elsewhere illustrated a much superior dust-control approach. The cover of "Lunar Bases and Space Activities of the 21st Century" [W.W. Mendell, Editor; Lunar and Planetary Institute, Houston 1985, ISBN 0-942862-02-3] shows personnel wearing what I have come to call the "Turtleback" suit, in which an oval hardshell backpack covers the torso and back of helmet. This backpack is hinged on one side, and entry to the suit is made through the opening.

"In prerelease conceptual illustrations Rawlings did for the David Lee Zlatoff/Disney/ABC '91 movie "Plymouth" (still the only science fiction film ever made about settlement and the idea of using lunar resources), there are sketches of turtleback conformal airlocks (my word) into which this specially designed backpack makes a sealed connection, then swings open, allowing the incoming astronaut to (pulling his hands and arms out of the suit sleeves) reach back and up through the opening to grab a bar above the inner door of the lock and pull himself out of the suit and into the habitat. The suit and most of its dust remains outside, perhaps to be stored automatically on an adjacent rack. Whether Rawlings himself ever thought through his artistic concept this far, or further, is unknown to this writer. But we want to give him full credit."

Next we need suits which are as light as they can be made, and agile! There are probably things we can do with both the boots and the laces to make the wearer more sure-footed in all types of lunar terrain, and more dexterous in handling samples, climbing, making repairs or performing service operations. If our moonsuits constrict our mobility and agility, making us "all feet and all thumbs," wearing them will exhaust us all too quickly, decreasing both the amount and the quality of work accomplished.

The amount of quality work that gets done per person hour is the name of the game. In time, it will also be a question of enabling people to go out on the surface to engage in field hobbies and out-vac individual or team sports. If we meet the needs of the scientists and prospectors, we will enable those with an "outdoors" recreational needs as well.

Out-vac exercise and sports activity of any kind will depend on the invention and debugging of a lightweight, supple pressure suit that can handle the heat and perspiration loads generated. If total out-vac exposure times are kept to an acceptable accumulative minimum, radiation protection can be minimized. Given the considerable benefit and boost to overall settler morale, the development of such a suit is sure to be on the collective front burner. Such suits will have to have many “smart” features we have described above. For both work and recreation, overall morale enhancement is the real prize. Upon this morale hangs the long term viability of lunar settlement. Now unlike providing sensory enhancement, providing EZ-wear suits that allow maximum mobility, agility, and dexterity is a goal much more easily described than realized.

Our intent is not to give clues as how we can meet these goals, but to define what these goals should be. NASA has long been aware of the shortcomings of its spacesuits and for a time was funding two different teams to come up with replacement designs. Then the work stopped. There may have been some Agency dissatisfaction with the results being achieved in the two projects underway. Each was promising advantages, but by means that were mutually incompatible so that all the proposed advantages could apparently not be realized in either design. But we think that the real reason for shelving these two projects was Neanderthal budget-cutting, by those who could not see the big picture, or cared.

This kind of R&D needs to be directed by a commercial enterprise that has a stake in the results and in the quality and quantity of work done on the Moon. For now, brainstorming and paper studies of radical new moonsuit designs that meet these objectives are about all we can hope to see -- until some intently for-profit consortium has a eureka dream that “there’s (a) gold(mine) in those (gray) hills!”

Active Helper Systems

One could also imagine a number of “helper systems” that would enhance the surface excursion experience even further. Power tool plug-ins Set II. In addition to tools useful in investigating rocks and minerals (drills, saws, core samplers, etc.) and various glove and boot accessories, we could “plug in” more exotic, even “handier” tools. How about an automatic laser device that would leave “Reeses Pieces” “hot spots” that would remain detectable for a few hours to assist the wearer in retracing steps especially in jumbled and confusing terrain?

Or how about a retrievable tethered mini “scamperer” probe that could reach spots (up/down cliffs and escarpments, inside crevices and clefts, etc. and other hard or inconvenient to reach areas) and either analyze what it detected and send back the data or pick up and return promising samples? The second season team at the Mars Society simulation outpost on Devon island discovered the surprising usefulness of such critters. They experimented with 100 m and 200 m tethers (leashes, anyone?)

We’d be delighted to hear from readers about more such active helper systems. Think of them as productivity maximizers and safety insurers.

The Fremen Stillsuits of Dune/Arakis

Okay, so that’s a bad title in as much as those who do not allow the pleasures and escapes of science fiction into their lives will have no clue of what it means. To Sci-Fi fans, no explanation is needed. So let’s try again.

Accommodating Human “Needs”

Our suits of the Apollo moonwalkers had provision for urination -- a definite improvement over the one Alan Shepherd wore less than a decade earlier. But these suits were made to enable stays of a few hours at most. We’ll want to do some trial and error experimentation with alternatives that will cover our butts, so to speak, for longer periods under both normal and distressed conditions (er when it’s Immodium time). Accommodating for regular bowel function (other than by the “low residue diets” fed to the Apollo crews) within the tight confines of a space suit will pose quite a challenge, but one we must meet sooner or later, so why not sooner?

Truly long-duration suits would have the capacity to recycle urine into drinking water, and for the uninitiated, that was the gist of the first subtitle for this section. Now that will make many queasy but it is no more than a very accelerated version of what happens in nature. So if this makes you ill at ease, get with the program!

Suits will have controls to adjust the gas composition of the air, and scrubbers to remove or recycle exhaled carbon dioxide. To create a "micro" biosphere system to handle all this indefinitely without frequent fresh inputs would seem an impossible challenge. Fortunately, some people relish "impossible" challenges. We predict breakthroughs in this area -- in time, and not by an "agency."

The ultimate backup system would be a "noninvasive" vital signs telemetry system. That is a nearer term goal, one we should find easier to meet.

Wrap Up – "Moonskin"

Actually, we are all born with a space suit of sorts -- our skin, which is one of the most important yet least appreciated of the body's essential systems. The skin works to keep our body fluids in and contaminants out. But this natural integument evolved to meet the challenges of our terrestrial

environment. Now as we move out into spaces and places beyond our native atmosphere, we do not have the time to let "evolution" do its work in spinning us an improved formfitting protection layer.

But the way the skin works without encumbering us to assist our mobility, agility and dexterity is the model we must hold before us in designing our "moonskins" the suits that will let us be at home on the Moon as if we were natives. With the right outerwear, we could operate freely on the Moon's surface and be attentive of all the clues the moonscapes hold. Well designed moonsuits well let us "belong" in our adopted homeworld.

Relevant articles from MMM issues past:

#89 OCT '95, p.5 "Dust Control" § "Engineering Countermeasures – Suit-Locks"

#96 JUN '96 p. 6 "Spacesuit Aversion" <MMM>

Could we be "at Home" on the Moon without Pets & Wildlife?

By Peter Kokh

In today's busy, high-paced over-structured society, many homes are without pets. More and more people have grown up without them, and have an acquired indifference to animals, if not a fear of them. Perhaps because of increasing exposure to environmental pollutants, a growing percentage of the population is now allergic to many things, pet fur included.

Put in historical perspective, this situation is a sad aberration. Humans have lived with animals from prehistoric times. Cats have been domesticated for six thousand years. Dogs have been a standard part of human households for over a hundred thousand years. In that light, it is clear that as a species, we have become "human" in the presence of wolves becoming dogs.

The value of pets to the development of individual personality is well-documented. The benefits for children and the elderly are even greater. Yet many previews of life on the space frontier, perhaps the forecasts of pet-deprived and animal-insensitive individuals, would make no place for pets. But for those of us who have had the good fortune to have our humanity more fully realized by pets, it is clear that as a fully human society we will never be "at home" on the Moon or anywhere else with "just plants".

Pets may not produce tangible benefits. But what they contribute to morale and to humanity, however intangible, is too immense to be written out of the picture -- even if a fraction of our population has grown aberrantly insensitive and immune.

Recently, I was interviewed by a local newspaper reporter who asked if I would go to the Moon "to live" if I was offered the chance. I replied, "In a heart beat, provided I could take along at least one of my three dogs." Not all of you will feel the same. But if only the pet-insensitive

are picked to go, the settlement that will result will only be a caricature of a truly human town, by all standards throughout time and in every corner of the globe.

And there will be a place for urban wildlife as well: hummingbirds, songbirds, bees, butterflies, fish and much more. Animal lovers still rule. <MMM>

The watcher is likely to be disappointed.

The doer has the comfort of knowing
that he has tried, and perhaps laid foundations,
for others who follow, and may reach the goal.

MMM # 152 – February 2002

Homes “at home” on the Moon: Thermally Self-Regulating Lunar Habitats with Backup Off-Grid Power Systems

By Peter Kokh

Impossible? We will feel more “at home” on the Moon if our homesteads are designed to play the lunar thermal cycles so as not to depend totally on any outside heating or cooling inputs. A power grid may be essential, but power grids fail. On Earth this is a matter of inconvenience: bundling up if it’s cold, meat spoilage if it’s hot. On the Moon a temporary power plant outage could be a death sentence for many, if not all, if there are no back up systems. And building a modular back-up capacity into each unit will certainly provide the best security of all.

We are talking about thermal equilibrium as well as electric power generating capacity. This goal is not something new. There are a small but growing number of homes in this country whose architecture and construction materials attempt to achieve an analogous “environmentally tuned” balance, first as to thermal management, second with respect to off-grid power generation capacity. On the Moon, this may well be a goal that will not be achieved without an even greater amount of trial and error experimentation. The time to begin brainstorming is now, however, as our security and survivability will be tenuous and fragile from the gitgo -- until we can start building in this fashion as a matter of habit. The reward will not only be safer settlements but the feasibility of small isolated rural outposts wherever they are needed -- and they will be needed!

Thermal Storage Systems

Paper studies of possible thermal storage systems can help to get a first read on the merits of competing approaches, the comparative difficulty of installation and the engineering and technical challenges of each. On Earth, architects and builders have come up with a variety of passive and active systems. Some of these may suggest analogous solutions that will prove workable on the Moon. Other solutions will prove to be uniquely terrestrial. But we should not limit our brainstorming to the exploration of the adaptability of schemes we have tried here. It would be rather surprising if we did not find some uniquely lunar solutions.

But to prime the reader’s imagination, here are some of the more common thermal management techniques tried on Earth:

- **super-insulation** to keep out both excess cold and excess heat. On the Moon, that may not be enough, even if the stress of more extreme dayspan heat and night-span cold is met. Daily living activities may produce a net heat excess that must be radiated to space to prevent steady heat build-up. Super-insulation with radiators are one approach

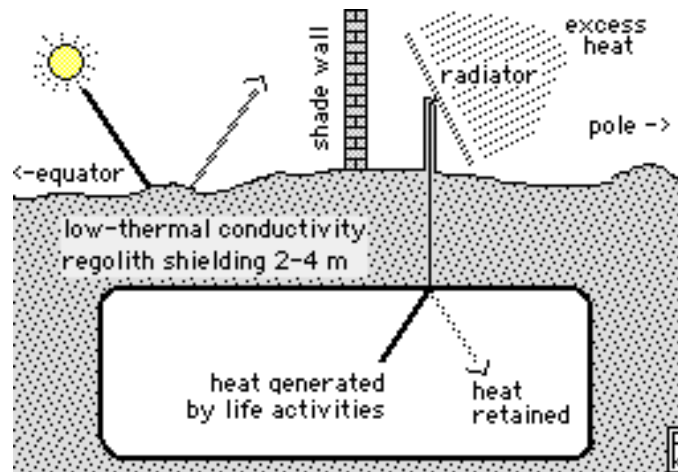

ABOVE: regolith shielding acts both to keep solar heat out of the habitat, and to keep heat generated by life activities within, Excess heat buildup is handled by shaded radiators shedding heat to the black cold sky.

- **passive solar** – allowing some solar heat to enter during the dayspan through periscopic windows and sun pipes that filter out most infrared wavelengths. This heat could be stored in massive reservoirs (cast basalt floor tiles, concrete hull, massive interior walls, water reservoirs etc.) for use during nightspan. A radiator system would still be needed to handle any net excess.

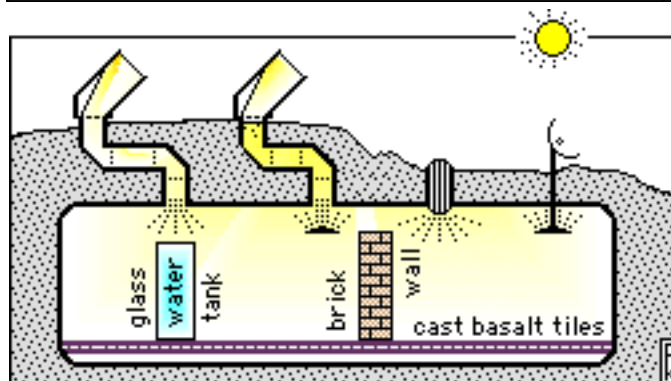
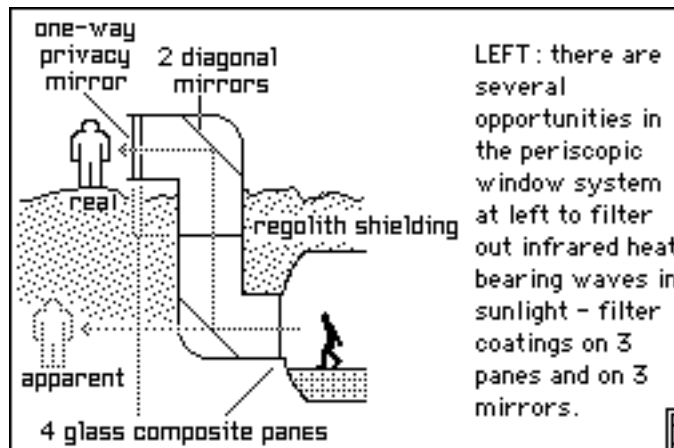

SHOWN: Controlled Passive Solar Inputs (heliostats and sun pipes with two types of light diffusers) and Thermal Storage Systems to radiate stored excess heat back into the habitat space in nightspan (massive floors, massive walls, and water reservoirs).

- **active systems using water reservoirs** to store cold as ice. Water is an ideal heat storage medium in itself, the more so because we will need to have an ample amount of it for biospheric stability. A water reservoir, connected to the homestead but exterior to it and insulated from the sun by two meters of more of soil, may be part of the solution. To shed excess heat, radiators may be needed. Want more of a challenge? Integrate semi-autonomous point source pretreatment of waste waters.

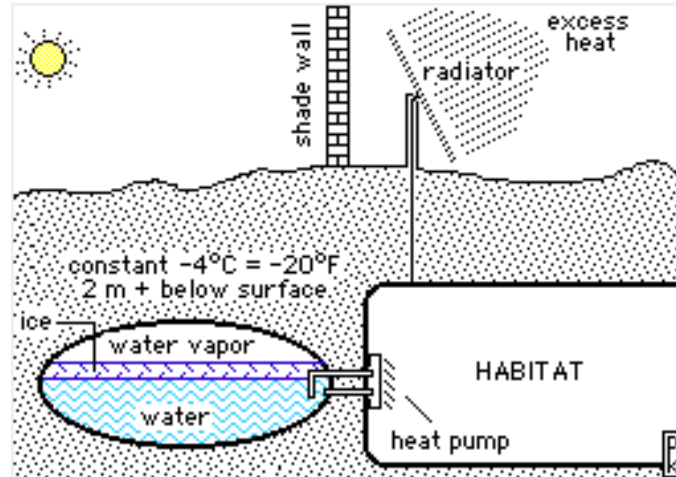

- **active systems: magma-based.** If nightspan heating proves to be a greater problem than heat build-up, one system that could provide nightspan heat and power too, would use excess solar power capacity to melt regolith during dayspan, store it in a refractive alumina-lined cavity underground, and tap its heat (steam-powered generator) during nightspan. David Dunlop came up with this idea, and it may be more realistic for a neighborhood-scale habitat-cluster implementation.

Translating systems that work on Earth to something that will work on the Moon

We have but a layman's knowledge of thermal management engineering issues. Our purpose is to encourage those with the expertise and terrestrial thermal management experience to brainstorm how we might engineer stand-alone self-regulating lunar habitat spaces attune to the lunar dayspan/nightspan rhythm that will function autonomously and worry-free off-grid, should there be a power interruption.

Not all of the great variety of schemes that have been tried on Earth with some success will successfully translate to unique lunar situations. But they are a starting point for brainstorming and we offer these ideas not to close discussion and experimentation but rather to begin it.

Electric Power Generation:

Cluster or Neighborhood Solutions:

In search of safety and security, we should look not only at individual pressurized structures but at the structure of the utility grids themselves. Centralization concentrates risk. A decentralized "cellular" grid structure with a "neighborhood by neighborhood" approach has advantages. By decentralizing power generation, building modular power generation plants so that each serves a cluster of pressurized structures or neighborhood, we provide a great deal of redundancy and resiliency. The fruit will be greatly increased "at home" peace of mind.

Whatever tricks we can master to maintain thermal equilibrium ought to include power generation survival systems that can operate off-grid for an appreciable amount of time, if not indefinitely. There are plenty of risks to pioneering the Moon. We need to minimize them, not increase them by over-dependence on centralized utilities that should be used to go beyond the minimum, not to provide it.

Off-Grid Electric Power Generation

If and when architects and structural systems engineers come up with plans that works to minimize the need for grid power to maintain a livable interior temperature range, we'll still

need to address the question of providing autonomous off grid power systems for lunar homesteads for back-up insurance and safety for other electric uses besides heating and cooling - communications, refrigeration, food preparation, etc. Every pioneer home should be able to operate as if it were a small isolated rural outpost.

Each habitat or pressurized space should have solar power panels of some type. These could be sized to provide a more than minimum power needed during dayspan -- enough extra to electrolyze waste water (thus recycling it at the same time) to run fuel cells for nighttime power and fresh water. This equipment should be a standard part of any habitat electrical system and a requisite for grid hook-up.

Minimizing the problem:

Dayspan and Nightspan in the home

Even while the settlement power plants and grid are operating normally, pioneers may get in the habit of living at a different pace in the alternating two week long stretches of abundant sunshine and unbroken night. Even with a nuclear power plant, there will still be more energy available in dayspan when solar panels and concentrators are also at work. Production operations will concentrate on power-intensive tasks during dayspan, leaving man-power-intensive tasks for night, when and where feasible.

Within their homes, on their own time, it will make sense for Lunans to organize their household chores in like fashion, again where feasible. These go-with-the-flow practices and habits will provide extra resiliency in case of a grid power emergency, putting less strain on domestic backup systems.

The Reward -- In preparation and resiliency lies security, and a sense of being "at home".

<MMM>

Reading from MMM Back Issues

#7 JUL '87, "POWERCO"

#43 MAR '91, pp. 5-6 "SUNTH Dayspan, Nightspan"

Being "at Home" is Completed by Being able to go "Outside"

By Peter Kokh

No matter how cozy the home, if you are a virtual prisoner inside, your sense of being "at home" will be most uncomfortably limited. But "outside" on the Moon means out on the vacuum-soaked, radiation-washed surface -- or does it?



The Concept of the "Middoors" [A synopsis from past MMM articles. See list at end.]

Thanks to the appearance in recent decades of enclosed climate-controlled shopping malls, the idea of something in-between the indoors and outdoors (a distinction as old as man) is now familiar to most of us. The "middoors" [i.e. between the doors of homes, offices, shops and the doors to the natural outdoors] is also prefigured in the landscaped, sunlit atriums in new hotels, office buildings and even cruise ships.

The beachhead science outpost will be simply a pressurized indoors up against the out-locks vacuum, the "out-vac". Whether in a government outpost or in an early company mining town, the construction of the first spacious atrium solarium garden will introduce a new kind of space - a space external to individual quarters, lab modules, and other work- and function-dedicated pressurized places, yet still keeping out the life-quenching vacuum beyond the air-locks and the docking ports. What we have called the "middoors" will be born.

From this humble beginning, airy, spacious, verdant middoor spaces will grow to eventually host the greater part of the settlement atmosphere and biomass. And with it, the hoped for “biospheric flywheel” will become much more of a reality.

It is within such spaces that longer, wider sight lines will appear, offering postcard views and vistas, to dull the edge of early day claustrophobia. The settlement will begin to take on the trappings of a little “world”, a continuum of varying horizons. The effects on settler morale will be considerable.

In Lunar cities, except to enter and exit those industrial facilities which for safety's sake must keep their air unmixed with that of the city at large, it will be possible to go most anywhere without donning a space suit. Homes, schools, offices, farms, factories, and stores will exit, not to the airless, radiation-swept surface, but to a pressurized, soil-shielded, indirectly sunlit grid of residential and commercial streets, avenues, and parkways; parks, squares, and playgrounds; and pedestrian walkways.

While the temperature of “indoor” spaces could easily be maintained at “room comfort” levels, that of the interconnecting middoors of the city could be allowed, through proper design, to register enough solar gain during the course of the long Lunar dayspan and enough radiative loss during the long night-span to fluctuate 15 °F on either side, for example from 55–85 °F during the course of the lunar sunth.

Middoor spaces could be landscaped with plants thriving on this predictable variation. This would be invigorating and healthy for people, plants, and animals alike, providing a psychologically beneficial monthly rhythm of tempered mini-seasons. Of course, the middoors could be designed to keep a steady temperature. Oh how boring that would be!

For perhaps the greater part of the population, the creation of generously-sized pressurized commons, nature and picnic parks and playing fields and parkways will satisfy everyday needs for the “outdoors.” Sheltered from the cosmic elements, such spaces may nonetheless have an airy, supportively verdant feel to them. Such public common spaces form a matrix within which the indoor spaces of homes, offices, shops, schools, and factories can literally “breathe”.

The more generous and more high-ceilinged spaces of the Lunan middoors can be realized by several architectural devices. Pressurized cylinders carrying vehicular traffic can have a radius generous enough to support green strips with hanging gardens, trees, walking and jogging paths, even meandering trout and canoe streams. Spherical or ovoid or torus structures can serve as more self-compact nonlinear park and nature space. Farming and food production areas can host public footpaths and picnic oases.

Sunshine ingress can be provided by bent path heliostat “sundows”, by optic fiber shielded “sun wells”, or more radically, as Marshall Savage suggests, by water-jacketed double domes.

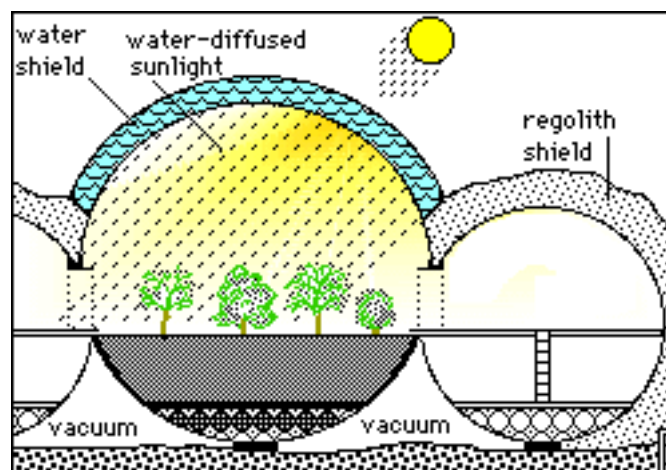

Well-designed middoor spaces in a generous acre per citizen ratio can probably substitute for the open air greenspaces of Earth for a large cross-section of the settlers. Others will need to come to personal terms with the out-vac. Still others will never be able to leave behind the green hills, the ocher deserts, the blue skies, the thick forests, the horizon to horizon expanses of ocean deep of the home world.

We will be able to walk, hike, bike, skate, row and trout-fish in lunar middoor spaces. Cherished outdoor activities that are more challenging to replicate but seem eventually doable include skiing and tobogganing in

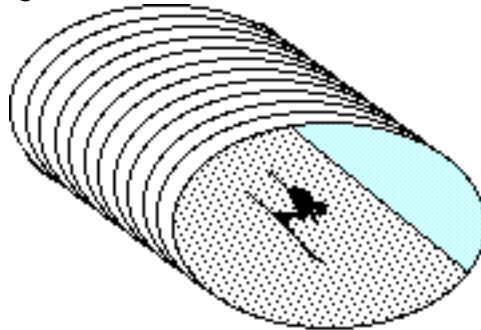

Also doable is man-powered flight. Out of the question, at least in the early days of settlement are activities like powered flight and soaring, skydiving, motor boating, sailing, ocean cruising and hunting for example. We'll be able to go caving or spelunking in lavatubes, but in pressure suits.

Each person pondering signing up for the lunar frontier must weigh his or her attachments to cherished activities that may not be supported in lunar settlement biospheres any time soon, if ever at all. Those taking the plunge will owe it to themselves to be politically and civically active in guaranteeing that the settlement middoors is as generous and diverse and user-friendly as economically possible. Nothing less than the morale and mental health and long-term survivability of the settlement is at stake.

While tightly climate controlled "indoor" spaces may vary but slightly from comfortable "room temperature" and humidity levels, the middoors may be designed to swing freely from a late pre-sunset dayspan temperature that is tolerably warm and humid, to a late predawn nightspan temperature just enough above freezing not to harm the various plant-forms within. "Sunthly" "weather" patterns will add welcome variety and spice to day-in, day-out life.

That favorite conversation-making unpredictability of terrestrial weather, however, may be hard to program in. If temperate food plants are desired, perhaps an annual hard frost might be arranged one nightspan a year, as part of a partial cleansing freeze out of accumulating atmospheric pollutants and impurities. It's a thought. And depending on ceiling heights of the street vaults, any gradual increase of humidity levels beyond a certain point might trigger mist-making condensations, say sometime after local sunset. At any rate, such middoor "weather changes" will help keep the populace healthfully invigorated, as well as supplied something innocuous to complain about. A fringe benefit will be a whole new cottage industry to create fashionable "outerwear".

Conclusion

The Middoors is an essential concept with a critical function in the design of lunar settlement mini-bio-spheres. Middoor spaces will include parks and parkways as well as agricultural areas, and thus host the lion's share of the settlement's biomass. Air circulation in the middoor maze of interconnected pressurized public spaces, markets, parks, walkways and streets will be an essential part of the air recycling system. Reserve waters as well as largely pretreated waste waters will also circulate through the middoors as part of the water purification system, providing fountains, waterfalls, trout streams, duck lagoons, and more.

Meanwhile, the middoors, even in modular settlements built unit by unit as needed (as opposed to vulner-able fixed-size megastructures so common on science-fiction rag covers)

will go a long way to prevent the build up of cabin fever malaise. In contrast to habitat modules, the larger diameter cylinders for roadways, bike paths, public transit, and roadside plantings, and even larger spherical, ovoid, or toroidal plazas, squares and parks will boast higher ceilings and longer sight lines for welcome eye relief.

There will be those “hard core” outdoor types for whom this will not be enough. And that is great. Their enthusiasm and relentless search for ways to make themselves “at home” in “Out-Vac” sport and field activities out under open black skies will end in pushing the envelope even further. That will be good. The wider the cross-section of normal personality types that can enjoy satisfying lives in lunar environments reclaimed from wasteland, the more truly viable will lunar settlement become longterm .

Meanwhile, lunar settlement Middoors spaces will allow Lunan pioneers to feel “at home” outside their homes as well as inside them. <MMM>

Relevant Readings from Back Issues of MMM

- # 5 MAY '87 “M is for Middoors” # 8 SEP '87 “Parkway” # 37 JUL '90 p 3, “Ramadas”
55 MAR '92 pp 4-6 “Xity Plans” – illustrated # 74 APR '94 p 7 “Sun Moods” –
illustrated
89 OCT '95 pp 3-4 “SHELTER on the Moon” # 94 APR '96 p. 4 “Vac, Out-Vac, Lee Space,
Midoors”
96 JUN '96 p. 6 “Spacesuit Aversion”

Security Comfort Levels

We won't be “at home” on the Moon until the Knowhow to Maintain our Presence is Widespread among the Pioneer Population

By Peter Kokh

In every culture throughout time, there have always been elders or an elite with special critical knowledge vital to the survival of the community. At the same time, other skills and knowhow are often commonly widespread in the population.

In our own society there are the nuclear scientists and brain surgeons and other experts of esoteric domains – a relatively small group of highly trained individuals. But there is still a considerable body of vernacular knowhow: auto repair, home repair and construction skills, day in – day out ability to use computers for a whole list of purposes, farming skills, and many more “trades” too numerous to mention. And then there are specializations, even of things once commonly known, simply because life is so complex no one can know even the basics about “everything” -- how to make soap for example.

We have become ever more dependent on higher and higher technology. Yet that dependence extends only to quality of life. Without it, we'd be knocked down a few pegs to a cruder, simpler time. But our survival would not be at issue. On the Moon and Mars, however, the stakes will be radically higher. We will be dependent on high technology for our continued existence at every moment:

- Maintenance of pressurization and seals
- Constraints on lunar architecture / construction
- Maintenance of ever more heavily biologically-assisted life support systems
- Plumbing and ducting systems that assist in the refreshing of the air and the water
- Biomass recycling and recovery
- Last but hardly least, maintaining a positive import-export equation.

Our thesis in this article is that our security on future adopted worlds will depend on such kinds of essential knowhow becoming, and remaining, widespread among the settler population; and that virtually everyone needs to understand the basics. Why? Because

Without citizen cooperation, the efforts to maintain these vital systems will be at real risk eventual failure.

For example, the best engineering possible of water, air, and waste recycling will be defeated without strong public cooperation. On Earth, these are important issues. But system failure is not a matter of life and death that threatens near term. Our planet gives us a generous biosphere. On the frontier, we have to provide this and maintain it our-selves. We cannot risk a settlement population becoming a misguided rabble.

The role of the settlement schools

Broad knowledge of the system of special expertise, systems, and engineering that make life in the lunar or Martian settlement possible can be guaranteed, by a simple plan, rigorously pursued. Starting in the earliest years, children can be introduced to the basic ideas behind human-created and maintained mini-biospheres and the systems that make them work: abundant plant life, the food production system, water and air treatment, etc. The concept of the pressure hull and threats to its integrity. Simple lessons and explanations at first, but as the children grow older, each subject should be revisited in ever-greater detail. What starts as a lesson, in time becomes a whole course. Periodic field trips to the settlement's utility facilities will help, with revisits as the child is older and can comprehend in greater depth.

Meanwhile, at home, children can take turns with housekeeping chores that help make the system work. Older kids can help sort recyclables, repair salvageable items, even disassemble products whose components need to be recycled separately. After secondary school, young people could do a stint of universal service in any one of several vital areas: hull pressurization patrol and maintenance corps; yeoman duty with architectural and construction firms; agriculture & biomass recycling; the water works; recycling utility, etc. The result of such mandatory service (for a length of time to be determined by the settlement) would result in very widespread appreciation of what it takes to maintain human presence on the Moon or Mars. And therein lies security.

At the technical school and university level, individuals who feel the call to be at the forefront of one of these vital fields, can pursue studies further. Settlement Systems 101 as an in depth introduction to all these vital systems would be a prerequisite to advanced courses and majors in any one of them.

The risk of ill-fated political decisions with unsuspected consequences that threaten the state of any of the settlement's essential systems, will be much less if the populace as a whole have a high degree of appreciation for what is at stake. On Earth we take the long-term existence of our cultures and their towns and cities for granted. To be sure, we have our ghost towns, places where something critical stopped working (generally the economy). On the space frontier our presence will always be tentative, our future a presumption. There can, of course, be no guarantees. But if the population at large is engaged in what it takes to continue to win against the odds, the chances of continued success will be that much greater. Without this broad widespread appreciation, the chances of an end to human presence on the Moon, a string of ghost towns in our wake, is high. Do it right, and we will be, and feel, "at home." <MMM/>

MMM # 154 - April 2002



Therapeutic Indoor Recycling Water Features

By Peter Kokh

Thanks to strong marketing by suppliers for garden pools and water features, both indoor and outdoor, these delights are finding their way into ever more gardens and homes each year. One can buy fully assembled predesigned units in a bewildering array of sizes and styles, or buy key parts and create one's own. Imagination, not cost, is the only limit.

Indoor "water features" would seem to be just what the doctor ordered to make lunar homesteads inviting retreats. The reasons are that they:

- Use only recirculating water reserves
- Require only lightweight imported pumps, hoses
- Can use basins made of many lunar materials
- Are an opportunity to "domesticate" moon rocks
- Are an ideal setting for plants
- Can be combined with fish ponds
- Offer several ways to add color
- Provide a treat for four of the five senses

Recirculating Water

The water used in these water features recirculates over and over. One must make up for evaporation, of course, but evaporated water is not lost to the biosphere as it can be recovered by dehumidifiers. It is essential that the outpost or settlement have more than marginal reserves of water as a matter of safety and security. But why not put such reserves "to work" in ways that improve overall morale? (see MMM #67, July '93, p. 6. "Reservoirs")

Imported Pumps

These water features use small pumps that are relatively light weight, plus hoses and clamps. It can be argued that the intangible benefits of having water features in homes, home gardens, and public common spaces is great enough to justify their import -- after all, the vast bulk of the weight (basin, water, and sundry adornments) can all be made locally.

Made on Luna Basins

Basins, pools and step pools need to be impervious to water and are commonly made of inorganic materials. On the Moon we can make such items from glassified regolith, glass composite, cast basalt, various metal alloys, glass-sulfur composites, and concrete. The choices are quite wide and will support a wide variety of sizes and variation in design.

Incorporating Moonrocks

Water feature designers often incorporate rocks in their creations. In nature, rocks are invariably associated with waterfalls and rapids. We won't find "river rock" anywhere on the Moon, of course, but we should be able to make interesting arrangements using larger moon rocks and breccia. As an alternative, we could "make" rocks by casting basalt or concrete in various shapes. In the first path, we find one more way to "domesticate" moon-rocks and thereby make the surface that much less alien to the eye.

Working in Foliage

Again, in Nature, foliage is commonly more dense and rich in proximity to water. We can make our house plants look more natural clustered around a water feature. With a little ingenuity and extra plumbing, we might even train the water feature to meet the watering needs of the plants.

Integrating Fish Ponds

In larger size fountain pools and waterfall basins, we can raise a variety of common aquarium fish species. Fish add surplus motion and color, and reinforce bonds with nature that would weaken if we had only plants to enjoy.

Avenues for Color

Integrating a water feature into the home or home garden, provides several opportunities to add extra color for the eye to feast upon:

- Moon rocks in direct contact with water or even just splashes of water, may tend to take on rusty patinas, to the extent of their iron content. Rust will be a warm tone that will provide welcome contrast to background gray tones of structural concrete, cast basalt, glass composite, or metal.
- The many greens of foliage. Plants go well with rust tones, by the way. Think terra cotta pots!
- Flowers and blossoms
- Colorful fish

Treats for Four of the Five Senses

The reader is welcome to try to identify ways in which water features provide a taste treat for the tongue. We didn't try. As to the other four senses:

- **Eyes:** The designs and shapes of fountains and waterfalls can be designed are limited only by the imagination. They can be rustic or crisply geometric, incorporating many textures. Amateur-friendly, they are also inviting to artists as well. Spot lighting can be used and/or underwater lighting. Plus colors!
- **Ears:** Soothing "white noise" that varies with flow and design.
- **Nose:** That fresh "after-the-rain" smell in the air.
- **Touch:** Textures of the different surfaces can vary from ultra smooth to quite coarse or even sharp. A randomizer added in to the ventilation system, could waft gentle fresh breezes around the surroundings.

Settlers need ample morale boosting perks. Water features will be among them.

<MMM>

N Nitrogen N₂	
Symbol N	Molecular Gas N₂
Atomic Number 7	Molecular Weight 28
Atomic Weight 14	

Nitrogen and the Moon's Future: Conservative use of this scarce critical element is key to "limits to growth" of Lunar Settlements

By Peter Kokh

Cosmically speaking, Nitrogen is one of the universe's more abundant elements. Earth's atmosphere is 79% oxygen. There is three times as much (by weight, not by percentage) on Venus. Mars' thin atmosphere is 3% nitrogen. Titan's thick atmosphere has more Nitrogen than that of Earth. There is plenty in the deep atmospheres of the gas giants.

All that does little good on the Moon. Unlike the Earth, the Moon formed "hot", condensing out of the hot plasma debris of a major crash between the proto-Earth and another early planet-in-formation. In the heat from the impact, almost all "volatile" elements, those with relatively low boiling points, were driven off into the surrounding space, never to be recovered. When the Moon coalesced from this debris, it formed "dry" - no water, no free gasses. Any carbonates were disassociated and the carbon driven off. Only oxygen, which forms tight stable bonds with most metals, was retained.

What nitrogen is found on the Moon is from two external sources, one known, the other surmised:

Known regolith reserves: nitrogen atoms in the thin but incessant solar wind have become affixed to the fine particles in the dusty topsoil blanket that covers the Moon: the regolith. This resource is primarily in the top meter or so at an average of 82 parts per million.

Possible polar ice reserves: if the suspected polar ices “found” by Lunar Prospector are confirmed by a “ground truth” probe, it is almost certain that they are derived from cold trapped vapors released when comet fragments have impacted the Moon. Comets consist not only of water ice, but of nitrogen oxide and carbon oxide ices as well, in a mixture dubbed “clathrate.” One of the primary goals of a polar ground truth probe would be to qualify and quantify this mixed ice bonanza. Someday there may be refineries at the poles producing CH₄ methane and NH₃ ammonia as well as water, for shipment by truck, rail, or pipeline to industrializing settlements in other areas of the Moon.

Off-Moon sources: import of nitrogen in the form of ammonia, from comets and asteroids if and when such resources can be economically developed to provide steady “pipeline” supplies.

The Bottom Line:

On Earth, an 1800 sq ft home with 9 ft. ceilings, at sea level, contains a half ton of nitrogen. To provide that much on the Moon would require gas scavenging an average of 6,100 tons of regolith at 100% efficiency. Anything we can do to cut that burden will allow settlement to grow more quickly.

Of all the elements essential for life (oxygen, hydrogen, carbon, nitrogen) it is nitrogen that is in shortest supply on the Moon in comparison to the amounts of it we are accustomed to using -- simply as the buffer gas for our oxygen-based breathable air. As settlements grow, it will not be shortages of hydrogen (water) or carbon that put on the brakes. It will be nitrogen that becomes the pinch point.

The Case for Reduced Air Pressure

One way to “go easy on the nitrogen” would be to simply maintain and regulate low ceiling heights in lunar settlements, not just in private quarters, but also in public places. Less volume of air means less tonnage of nitrogen. Such a Spartan constraint would not exactly foster high morale, especially over the long haul. But without other ways to conserve, we may well be facing such a gloomy prospect .

What else can we do? Reduce the air pressure in habitat areas. Additional savings could come from reducing the relative abundance of nitrogen in the reduced atmosphere, keeping the partial pressure of oxygen closer to what we are accustomed.

Readers who frequent the Artemis Discuss List will no doubt be exasperated by this suggestion.

“Oh no! We’ve been through all this before! It can’t be done, and NASA uses Earth normal pressures and mixtures in space. An Artemis-list discussion hashed this out in considerable detail. It is not true that we cannot live in lower air pressure. Air pressure at 7,500 feet is not significantly less than at sea level.”

With all due respect to those who took part in this discussion, we believe all the premises behind these assertions are flawed and inaccurate. It is vital for those of us who have faith in a bright future for lunar settlement to seek out a second opinion.

The Facts:

A table on the reduction of air pressure with increasing altitude is available online at:

<http://www.cleandryair.com/AltitudePressure.htm>

Sea level air pressure is the equivalent of a column of Mercury 760 mm high (30 inches).

Here is what the table shows for some higher altitudes:

Altitude	Pressure	% (1 ATM = 100%)
7,000 ft.	586.7	77%
		(Mexico City’s 22 million live at 7,600 ft.)
8,000 ft.	564.6	74%
		(Bogota’s 7 million live at 8,600 ft) (Nairobi’s 2 million live at 8,800 ft)

9,000 ft	543.3	71.5%	(Quito's 1.5 million live at 9,500 ft)
10,000 ft	522.7	69%	(Cuzco's 300,000 live at 10,600 ft) (La Paz, Bolivia's 1.5 million live at 11,800 ft)
15,000 ft	429.0	56.6%	Millions have been on top of Pike's Peak, 14,000 ft

Can thirty five million people be wrong? It is quite clear from these figures and the interposed list of high altitude cities where millions live, that the Artemis-list conclusions are prima facie in error.

"Nevertheless, a very large portion of the population has difficulty adjusting. Also note the life spans of the places you've listed."

It was noted during the Mexico City Olympics (1968) that those athletes who live at lower altitudes had enormous difficulties competing, unless they had the foresight to come to Mexico City a week or two early to acclimatize themselves. Those who did so did well. And life spans relate to medical care.

The argument from the experience of some people who have difficulty adjusting is irrelevant. It cannot be expected that everyone would be able to adjust to life on the Moon or Mars, and there are a lot of reasons for that: claustrophobia, black sky blues, loss of open-air living, lower gravity, air pressure. We know all that, and have always known it.

Pre-screened settlers will come from the ranks of those who tolerate all these conditions well.

All that is necessary for settlements to thrive is that there are enough who can adjust.

Those who argue from the admitted fact that some cannot adjust ignore the rules of simple logic. "Some people do not make good parents, therefore parenting is unwise." Same type of argument.

There are a great many skeptics about the rationality of our faith that humankind can sow itself on other shores beyond Earth's. "We were evolved at 1 ATM and 1 G and it is not possible for us to be pre-adjusted to tolerate anything less!" If we are to give in to them on the atmospheric pressure question, then we might as well give in to them on the gravity issue. But let's not. Life is about adaptation, not only over many, many generations, by evolution, but within the experience of individual lifetimes. Humans originating in East Africa have dared to step out of "their niche" over and over again to the point where we now thrive from the polar arctic to the high altiplano of Lake Titicaca and La Paz, Bolivia.

Why Air Pressure is a Critical Issue

The suggestion to use reduced air pressure in our outposts and settlements on the Moon and Mars is not lightly made. It is simple physics that the higher the inside/outside pressure difference, the greater the propensity to leak air, and the greater the likelihood of seal failure.

And this likelihood increases on a geometric scale. Choosing a reduced air pressure is then first of all a matter of common sense safety. The Moon and Mars are very unforgiving places. If we respect the dangers and the risks, our chances of successful transplantation to either world will be that much greater. Not to do so based on assumptions born out of history or habit or respect could invite failure. We have a saying that "it is easier to find forgiveness than to get permission." That approach works with people and institutions, but not with Nature.

Extra incentives for Lower Pressure on the Moon

On the Moon we have three additional incentives to use reduced air pressure in our habitats:

- The more our habitats leak, the more likely we will end up "polluting" the lunar vacuum to the point that it ceases to be a major industrial and scientific resource.
- The more our habitats leak, the more nitrogen we **will** lose (nitrogen is enormously more difficult to come by on the Moon than oxygen) and the sooner we'll reach the Moon's "carrying capacity"

- The less nitrogen we use as a buffer gas in our habitat atmospheres, the less expensive it will be to provide higher ceilings in public spaces as a welcome relief to eye strain and cabin fever.

Reducing Nitrogen Richness as well

One of the cases made against reduced air pressure is that “some” people have difficulty adjusting to it. Aside from the irrelevance of this argument, the difficulty cited comes entirely from the proportional reduction in the amount of oxygen. But who says we have to keep the same gas ratio we have on Earth (79% nitrogen, 21% oxygen)? What if we were to keep the oxygen partial pressure at comfortable levels and achieve all of the reduction in total pressure by reducing the amount of nitrogen gas used as a buffer? The following table assumes just that:

Mix (N/O) (N2/O2)	Pressure (%1ATM)	N2 Savings (tonnage)
75/25	84%	20%
70/30	70%	38%
65/35	60%	51%
60/40	52.5%	60%

But, but ... fire risk and oxygen poisoning

Most of us know the dire consequences to the Apollo 1 crew of using an atmosphere of 100% oxygen. One spark and they were toast. There is, however, an enormous difference between 0% nitrogen and say 60%. But let’s humor those concerned about fire risk and admit, for the sake of discussion that a 60/40 nitrogen/oxygen ratio makes combustibles more likely to ignite.

On Earth we are surrounded by combustibles. For one thing we use a lot of wood, a lot of plastics. On the Moon, however, items made of wood and other organics, natural or synthetic, would be very very pricey. We will need to reserve all the nitrogen, hydrogen, and carbon we can harvest for biosphere biomass and food production cycles. On the Moon we will rely much more heavily on inorganic substitutes: metal alloys, ceramics and cast basalt, glass and glass composites. The typical lunar home, office, school, or other kind of space will have very little in the way of combustible materials outside of clothing, bed sheets, towels and the like. Even the casings for electrical wiring are more likely to be of woven fiberglass than Romex plastic. Electrical fires will be much less common than on Earth.

All this is good, because fire is far more likely to be fatal on the Moon than on Earth, You can’t just open a window to let out the smoke. You can’t just open a door and escape outside. Future Mars settlers will be under no such materials rationing restrictions. The sad twist is that the incidence of fire and fire fatalities on Mars is likely to be much greater.

Some fear oxygen poisoning in an oxygen enriched atmospheric mix. But this phenomenon only occurs when the oxygen mixture is near 100%.

Don’t sea level crops need sea level nitrogen?

On the Moon we are surely going to want to grow more than coffee, tea and other crops usually associated with high altitude. The altiplano of Peru and Bolivia are not exactly gardens of Eden or bread-baskets to the world! Yes, but!

It is true that this high altitude area on Earth is no green paradise. Is that the result of reduced nitrogen? If that is the conclusion you want to reach, it will be the most plausible answer. But in fact, the altiplano is relatively infertile for climate reasons that have nothing to do with the reduction in nitrogen partial pressures. The area is colder because it is higher up. And because it is on the lee side of the Andes, it is drier, and windier.

Dry, cold, windy -- not exactly the conditions that make for rich, fertile soil. But to jump from that fact to the conclusion that reducing nitrogen partial pressures will mean cold, dry, windier lunar settlement interiors with poor soil is absurd.

In fact, in response to the quickly rising population of the area, especially around La Paz, there has been much agricultural research of late and the results are amazing.

- <http://www.idrc.ca/books/reports/09highla.html>

- Onions, radishes, beets, and carrots and lettuce at 4,200 meters (13,839 ft.)
 - Potatoes: three harvests a year in greenhouses
 - <http://www.eco.utexas.edu/graduate/Blubaugh/papers/ISEEpaper.htm>
 - Sustainable development in Bolivia's Altiplano
- If you do a web search for altiplano crops or altiplano farming, you will find much more evidence to support the conclusion that high altitude and lower nitrogen partial pressures do not mean having to live on coffee alone. But how can this be?

Simple. Most plants do not get their nitrogen directly from the air. They absorb nitrogen from the nitrates in the soil, put there by microorganisms that can fix nitrogen directly from the air. Some plants, like legumes (bean family) live in symbiotic association with such microorganisms and planting them enriches the nitrate content of the soil. But the bottom line is that nitrogen-fixing microorganisms thrive at all virtual altitudes under discussion. "Sea level plants" do not require "sea level nitrogen."

NASA Studies

What about NASA studies? The assertion is that NASA has studied all of these questions exhaustively and come to the conclusion that sea level air pressure and mixture is best. Why else would both the former Mir and the International Space Station use 14.7 pounds of air pressure?

NASA has done many great things. But there are good reasons to believe that it is highly unlikely that research on this question has been exhaustive.

- NASA has never looked that far ahead to the point that human expansion might be limited by the availability of nitrogen. NASA's lunar outpost studies have focused on small crew installations with individuals serving short terms of duty. For NASA to spend research dollars on "far future" options would be wasteful in that light.
- NASA has wisely chosen standard sea level air pressures and mixtures because man-hour time in space is prohibitively expensive, too much so to waste any of it on "adjustment time." Once we start talking about settlements, where people have come to spend the rest of their lives, a short period of adjustment difficulty (for which all volunteers will already have been pretested before leaving Earth) is hardly a major concern.

But is it not brash and rash and disrespectful to NASA to request fresh research? In science, it is standard practice to check and recheck results of others. In medicine it is standard practice to request second opinions. If NASA is offended, then it has put itself on some sacrosanct pedestal above other scientists and researchers. No disrespect is intended.

There is simply too much at stake on this question to settle for results of past studies there is every reason to believe have not been exhaustive or free from preconceptions that tend to color results. Instead, let's put all prior conclusions on hold, and mindful of the non-trivial consequences, examine the facts afresh with an open mind.

We owe our dreams that much.

<MMM>

MMM # 158 – SEPTEMBER 2002

Farming on the Moon

By Dave Dietzler <Dietz37@msn.com>

It has been argued that lunar agriculture is not feasible primarily because of the power demand for crop illumination. Greenhouses will need thick glass roofs, crops will be killed by solar flare radiations and overheating of the greenhouses during the two week-long lunar day will occur. None of these arguments are valid, and they reduce the credibility of the Mars First camp, of which most Lunans are actually members.

Thick glass roofs will not collapse in the low gravity of the Moon. Greenhouses will be exposed temperature extremes that will cause expansion and contraction of materials that

could lead to cracking and other structural failures. Micrometeoroid damage is another hindrance. The fact is, greenhouses will not be used on the Moon. Fresnel lens collectors and light pipes will transmit sunlight to farm chambers in sub-selenar lava tubes which might be hundreds of feet in diameter and many miles long. Areas inhabited by humans in these lava tube cities will also be lit by light pipes and skylights. Underground farms will enjoy a constant temperature of a few degrees below zero in the surrounding rock rather than 250 °F. days and minus 250 ° nights. It will be easy to warm the chambers up to 72 °F. with waste heat from nuclear reactors. Radiation from galactic cosmic rays and even the strongest solar flares will be no problem deep beneath the Moon. Micrometeoroid punctures will be unheard of. Overheating or "supergreen-housing" will not occur.

Illumination during the two-week long lunar night will be produced by microwave sulfur lamps with flexible fiber optic light-pipes that direct the light to the places where it is needed most. Light will not simply be scattered all over the place to be absorbed by the stone walls. Sulfur lamps will provide light in the visible range with very little infrared or ultraviolet. These revolutionary light sources can produce 95 lumens per watt.¹ Incandescents yield only 20 lumens per watt and fluorescents give 50 lumens per watt. Sulfur lamps don't even have electrodes to burn out!

In the past, illuminance recommendations were not as high as today's. In 1925, A TextBook of Physics suggested that night time street lighting required less than one lumen per square foot. The average living room only a few lumens per square foot. Offices and classrooms needed 5 to 10 lumens per square foot. Workplaces where fine handicrafts, engraving, sewing or drafting were being done needed 10–20 lumens per square foot.² Today, we find values of 75 foot-candles (one ft. candle = one lumen/sq. ft. or 10 lux) for reading and office work, 50 ft. c. for machine operation and 50–300 ft. c for bench work.³

The noon-day Sun gives off 10,000 lumens per square foot at Earth's surface! Plants need more light than humans and animals do, but not this much. Many plants only need 200 lumens per square foot for good growth! The small tropical Chinese Evergreen plant, *Aglaonema modestum*, only needs 100 lumens per square foot (same thing as 100 foot candles) and can get by on as little as 10 lumens per sq. foot.⁴

The Bamboo Plant, *Chamaedorea erumpens*, requires just 100 to 150 foot candles. The coffee plant, coffee arabica , a necessity for us groggy old lunar prospectors and rich travelers, needs 150 to 1,000 lumens per square foot.⁵ Tomatoes, sweet peas and ever-bearing strawberries need 1500–2000 foot candles and cucumbers require 4000 foot candles.⁶ If these plants receive 1500–4000 lumens per square foot from free sunlight during the lunar day and just 1000 foot candles for 16 hours out of every 24 hour period from sulfur lamps during the lunar night they will do just fine.

A thousand foot candles is like a cloudy day. Although the Sun might drench the Earth with the energy of 4 MW per acre, 1000 MW per square kilometer, and 2500 MW per square mile, only a tenth of this is needed for light hungry plants like the coffee plant. A one acre garden plot in a lunar lava tube illuminated by sulfur lamps will need 43,560,000 lumens to deliver 1000 lumens per square foot. Only 460 kilowatts will be necessary for one acre if sulfur lamps rated at 95 lumens per watt are used. To illuminate a square mile of lunar gardens, 290 megawatts is needed.

This is not impractical given the intense, constant solar energy that's never obscured by clouds available by day on the Moon that can be harvested with silicon solar panels or polished magnesium solar thermal collectors and stored in the form of hydrogen and oxygen that can energize fuel cells for electricity by night. Nuclear reactors can also be used on the Moon with impunity. There is no air, no groundwater, no wildlife and no ecosystem on the Moon that could be harmed by a meltdown or nuclear waste dump. Nuclear fuel could be reprocessed and breeder reactors could be used to tap the energy of plutonium. Massive containment buildings won't even be necessary. Terrorists will never make it to the Moon and if they do they will never make it back to Earth.

Although we can generate the electricity needed to furnish the crops with light, there are many other strategies to make lunar farming successful. It has been found that plants can be grown for two weeks at a time in sunlight and then put into "suspended animation" in darkness by refrigerating them for two weeks at a time. By doing this, some crops can be raised with no artificial light or power drain at all.⁷ Mushrooms can be raised in the dark. Three pounds of edible fungi per square foot of garden space can be harvested every fifteen weeks.⁸

Algae like Spirulina can be cultivated during the lunar day. Since blue-green algae can double its mass four times a day, in five days 100 grams of algae could reach a mass of 100 metric tons if it has enough water tank volume, minerals and carbon dioxide. It is therefore possible to grow enough algae while free sunlight is available during the lunar day to feed livestock throughout the month. Fish can eat algae. Goats and pigs will eat anything. Algae is actually very nutritious, high in protein, minerals and vitamins. Chickens might eat pellets of algae.

Mushrooms could feed the animals too. Moon dirt could be mixed with algae and mushrooms, allowed to rot and form a rich compost, and earthworms could be farmed in the rich dirt. Chickens and fish will eat chopped worms. Livestock won't need more than a few lumens per square foot to see. Fungi and worms won't need any light and algae only needs to grow by day. Clearly, a lunar diet rich in fish, chicken, eggs, pork, goat meat, goat's milk, cheese, butter and cream can be produced without artificially illuminated crops at all!

Eggs and liver are rich in vitamin A, so no one will die due to a lack of carrots. Meat has plenty of B-complex. Milk contains vitamin D or people can just sunbathe for 10-20 minutes a day. Some vitamins C and E are still desired, and so is some fiber. Some wheat for whole wheat bread and dough, tomatoes, potatoes, lettuce, grapes, strawberries, cucumbers and pumpkins can be grown with sulfur lamp illumination by night or by using the nighttime refrigerating technique, which will not require any heavy machinery; we will simply turn off the heat in the garden chambers and let them cool down.

A diet heavy on meat, fish and dairy products consumed during a two-week vacation on the Moon will not irreparably damage anybody's coronary arteries. Hotel workers, miners and scientists spending a couple of years on the Moon won't die of heart disease either if they stay fit. Fish, chicken and lean goat chops might be preferable to lots of eggs, heavy cream and bacon for the health conscious Lunans.

The Moon will never support billions of people as Earth does or Mars could after centuries of terraforming, but it doesn't have to. Millions of miners, scientists, workers and tourists who are the life blood of the Moon can be supported by the underground farms in lava tubes and man-made tunnels that will someday be planted in the Moon. Eventually, craters will be domed over with giant bilayer silicone bubbles with five meter thick water shields for radiation protection.⁹ Fusion power plants will supply electricity for the sulfur lamps and the resources of near Earth asteroids will be utilized. Subway tunnels will interconnect the domed craters. The Moon will become a fantastic playground and a jewel for all citizens of Earth, like the Great American West today.

<DD>

REFERENCES:

1. [WWW.SULFURLAMP.COM](http://www.sulfurlamp.com) General Technical Information page, Innovative Lighting: 2000. <<http://www.sulfurlamp.com/tech.htm>>
2. International Dark-Sky Association-Information Sheet 114. "Illumination Levels, Then and Now." excerpts fr. A Text-Book of Physics, Louis B. Spinney. <<http://www.darksky.org/~ida/infoshts/is114.html>>
3. "Table of Illumination Requirements." <http://www.google.com/search?q=cache:PFMEUU_z9KcC:www.olemiss.edu/depts/environmental_safety/light.pdf+illumination+requirements&hl=en&i8> http://www.olemiss.edu/depts/environmental_safety/light.pdf

4. David H. Trinklein, "Lighting Indoor Houseplants." Agriculture publication G6515. University of Missouri, Columbia: 1999. <<http://muextension.missouri.edu/xplor/agguides/host/g06515.htm>>
5. Clemson University Cooperative Extension Service. Home&Garden Information Center. "Indoor Plants–Cleaning, Fertilizing, Containers and Light Requirements" HGIC 1450 <<http://hgic.clemson.edu/factsheets/HGIC1450.htm>>
6. Growco Indoor Garden Supply. Intense Lighting Tutorial from 4hydroponics.com. "High Intensity Indoor Lighting lets you outsmart nature." <http://www.4hydroponics.com/lighting/lighting_help.htm>
7. Peter Kokh, "Lunar Agriculture Experiment" 2000. <http://www.lunax.org>
8. Mushroom Council. "Six Steps to Mushroom Farming." The Penn. State U. College of Agriculture, Extension Service. University Park, PA. <<http://www.mushroomcouncil.com/grow/sixsteps.html>>
9. Savage, Marshall T., The Millennial Project. Little, Brown & Co., Boston: 1994.

MMM # 160 – NOVEMBER 2002

Will Settlement Change The Moon's Appearance?

By Arthur P. Smith and Peter Kokh

Thoughts on a Controversy & Artists to the Rescue Arthur P. Smith <apsmith@aps.org>
10-27-02

A couple of thoughts I had:

(1) We've had this slight bit of controversy the last six months or so [in the Moon Society discussion lists] about "development" of the Moon, and how that could spoil it for all the Moon lovers down here on Earth. I think some images showing the potential for transformations of the face of the Moon in future might gain us a lot of good will. The Heinlein cover with split Earth/Moon that Ian [Ian Randal Strock, Editor] ran on Artemis magazine recently is an example of the idea – would the Moon not be more beautiful if it was endowed with the colors of life, rather than its current grayscale desolation?

You could start from a full-Moon image as it is now, focus in on, say, Mare Anguis and a lava-tube development, making at first almost no perceptible change in lunar appearance. What change in fact would it make? The shimmer of solar panels? Radiators hidden from the sun? A variety of mining vehicles, and a landing/launch facility on the surface... Would any trace of the inner life seep through a "skylight"?

Then fast-forward a few decades – the shimmer and skylight effects spread, new structures rise above the surface; a "mass driver" or two are installed for transport of lunar materials elsewhere; lunar solar power stations covered with solar panels and dotted with radio telescope-like transmission antennas appear. But all of these would be close to invisible from Earth – what would such changes in relatively tiny patches of the Moon (less than 1% of area, more on the edges than in the center) look like from that enormous distance?

Development then spreads further – craters are enclosed, some locations become highly desirable, others less so. Clusters of blue-green-brown appear amid the grey. What would our moon look like, with tiny flecks of color, concentrated here, sparser there?

(2) Sublunar life. At first a lot of what is done will be underground, for radiation protection and thermal stability. How will agriculture and industry mix beneath the surface? Lighting and temperature in an ambient –20 C environment. Lots of mushrooms growing in the dark? Chickens, rabbits, pigs on a farm? Giant sulfur lamps lighting acres of growing wheat and corn? Algae growth pools and drying facilities. Workshops where bulk lunar metal is forged, and united with electronics and light machinery imported from Earth. Sports arenas. Homes that are some cross between a cave and a modern cottage. And some airlocks, barriers, and other safety devices to guard against loss of atmosphere.

There's lots of things an artist could work on, fleshing out the vision we have of lunar development. I'd love to see it happen!

AS/PK

Changing the Moon's Appearance: & Reality Checks

By Peter Kokh <kokhmmm@aol.com>

Near term, I doubt that we could do much that was noticeable. If we did widespread harvesting for surface volatiles, such a "gardening" operation would tend to raise the albedo a bit for the areas covered, making them brighter.

Surface Night lights from the settlements might be noticeable in telescopes, but a settlement would have to be pretty humongous for its surface lights to be noticeable from Earth. Most of the activities that are supported by outdoor lighting on Earth would take place indoors or middoors on the Moon. Surface roads would be fewer in number than the subsurface ones at least in urban areas.

That said, I'm all in favor of a lighthouse beacon on the Moon at the intended settlement site before the first Moonbase module is landed. Green light is supposedly the most visible, and also the least disconcerting. Green signifies "life," "okay," "go."

Most changes would be so gradual, that no one would really notice. In stark contrast, the changes we have wrought on Planet Earth as visible from the Moon over the past century must be startling! The bright light clusters from urban areas and gas field burnoffs are something new in the past century for prospective observers on the Moon. but I think most would see that a beauty, not pollution.

There are concerns, but I think less about mining activities and other physical alterations that might change the appearance of the Moon to lovers on Earth. I worry about something else, something more difficult to fight, something much more insidious.

If our habitats were leaky and there were enough of them, there might be some slow faint rusty gray patches around settlement areas as some of the free iron fines were oxidized by traces of humid air. As more and more volatiles are pumped into the vacuum from rocket exhaust and leaky airlocks and seals, the longer it will take to dissipate into space. In time the extremely tenuous lunar atmosphere would be come progressively less tenuous. There would be more and more rusting, and someday, even occasional dust clouds.

We have written about dock-locks, snuglocks, barometric airlocks, turtle back suits, iron fine burning rockets, and other contraptions that might help conserve air, slow leakage losses, and slow vacuum degradation. The lunar vacuum is a priceless scientific-industrial resource. We shrug our shoulders at its slow contamination to our ultimate irrevocable loss.

<PK>

MMM # 164 APRIL 2003

Agriculture on the Moon: "Seasonal Crops" Year Around

By Peter Kokh

Spring is here in the Northern Hemisphere, and at least in the hearts of some of us with an available plot of land, that leads to garden planning or garden-dreaming at any rate: vegetable gardens, flower beds, landscaping, etc. So let's transpose ourselves to Luna City for a moment.

On the Moon there are no seasons, just the eternal cycling of dayspan and nightspan every 29.53 Earth days. Inside lunar settlements, shielded by layers of regolith against extremes of hot and cold, cosmic rays, solar flares, and micrometeorite rain, we will be able to pick the mini-biosphere climate we want. Perhaps we'll decide to allow the temperatures in common "middoor" spaces of settlement streets and parks to vary naturally from a late dayspan high in

the mid 80's (31°C +/-) to a late nightspan low in the low 50's (12°C +/-). Of course, we could keep it warmer, cooler, or allow an even greater fluctuation.

Our crops can be grown in separate areas with their own temperature and humidity controls. It'll be easy to grow subtropical and tropical plants. But what about plants that seem to require a winter reset, a chilling period, or even a hard frost before they can sprout afresh? Many of us are very attached to such crops, among them most of the berries and other common fruits. We may have to grow them under conditions that provide a simulated winter. Not being tied down to the annual cycles of the solar year, we would want to have as many harvests per year as we could cycle through the necessary stages.

We could experiment, but experimenting takes money. On Earth, experiments get done when the economic circumstances make the potential payoff attractive. And this seems to have been happening on its own the past few years with respect to Raspberry production. The happy result is that we now have the knowhow to produce these delicious berries year around in climate-controlled greenhouses: a perfect model for lunar settlement agriculture.

Raspberries will not begin to grow even in warm temperatures until their specific amount of chilling required to terminate rest is satisfied. The chilling required to break rest varies between varieties / growing conditions and is between 600 hrs (25 days) and 1500 hours (63 days) at temperatures below 40 °C (39.2 °F) for maximum bud break and growth. Bud growth will occur when plants are exposed to favorable temperatures after this chilling.[1]

The Economics of Winter Raspberry Greenhouse Crops

Consumers demand a year-round supply of high quality raspberries, as is evidenced by their willingness to pay high prices for fruit imported from Chile and elsewhere during the winter months. Happily, in northern raspberry growing areas such as Washington, Oregon, British Columbia, New York, Ontario, greenhouses are empty during the winter (greenhouse production of edible products has been limited primarily to tomatoes, cucumbers, peppers and lettuce.) Using this available capacity for raspberry production is ideal because only moderate energy inputs are needed, and production is possible under low light and under relatively cool temperatures. Two more plus factors are the commercial availability of bumblebees hives for pollination and the ready availability of the most successful cultivars.

Results to date have been good. Compared to field production, greenhouse-produced berries are larger, firmer, and much less prone to fruit rot. Fruit tends to be slightly less sweet and more acid in the greenhouse, but well within the limits of acceptability. [2] Further, it is proving possible to piggyback other crops on this production: Strawberry plants can share space with the successive raspberry crops, the strawberries in overhead troughs and the raspberries in pots on the ground. [3] Given this happy congress of conditions, it is no surprise that much experimentation has been going on in recent years [4].

Can this success be repeated for other "seasonal" crops? Future Lunans have a stake! Serious greenhouse gardeners can experiment with other fruits and berries (and vegetables, if any) that need a chill reset before the next growing cycle. We can also experiment to see which varieties do better in hydroponic, which in geponic setups. what's next – other seasonal crops that need chill resets

Such experiments are incomplete, however. We also need to breed varieties ideal for the dayspan/nightspan lighting regimes in lunar outposts, aiming for two dayspan one nightspan (44 day) and three dayspan 2 nightspan crops.(7) with late nightspan germination okay and early nightspan harvest and bed turnaround

Those without green thumbs but with engineering and/or architectural expertise can support this effort by designing greenhouse rack/conveyor systems to stack the plants compactly in chill mode, spread them out for maximum sun in growth mode, etc. Farming equipment designers and manufacturers are very much part of the green revolution on Earth, and will be on the Moon as well! <MMM>

Footnotes :

[1] <http://foodfarm.wsu.edu/GreenhouseRaspberries.htm>

- [2] <http://www.umass.edu/fruitadvisor/fruitnotes/FNarticle65-05.pdf>.
 [3] <http://www.annexweb.com/greenhousecanada/story2.html>
 [4] Growing Raspberries in Greenhouse: A One Day Workshop, 27 March 2003, U. of Guelph, Simcoe, Ontario, CANADA <adale@uoguelph.ca>



By Peter Kokh

Just the Facts

The Moon's axial tilt is a negligible 1° . So annual seasonal effects of this tilt in the amount of insolation, solar heating per unit of surface area, is negligible except at the poles themselves. More significant is the annual variation of the Moon's (and Earth's) distance from the Sun. That distance is least ("perihelion") at the beginning of January, and greatest ("aphelion") about July 1st. The extra thermal buildup in the regolith top layer blanket of moon dust lags somewhat and is about 3°C (5°F) higher in March than in September. That will mean that much more of a burden on excess heat radiator systems. If the radiators are not up to the extra load, that might mean slightly warmer interior temperatures in settlement open spaces or Middoors for that period. Not quite what we would dignify as a "seasonal difference."

Such a minimal fluctuation should be easy enough to damp out, or temper, with the shorter 29.53 day long sunthly cycling of exterior dayspan and nightspan having a much greater effect on the climate within the settlement biosphere. Middoor (parks, streets, other common spaces outside of residences and offices and work places, but inside the settlement "hull" could be allowed to fluctuate naturally in a tempered sunthly pattern from say the mid-80's $^{\circ}\text{F}^*$ towards approaching sunset to the mid-50's $^{\circ}\text{F}^*$ towards sunrise two weeks later. This is a design question and something the settlement founders and biosphere engineers can decide before hand, in choosing their "climate."

* F -4 5 14 23 32 41 **50 59** 68 77 **86** 95 104

C -20 -15 -10 -5 0 5 **10 15** 20 25 **30 35** 40

Separate settlements may well choose differing upper and lower temperature limits, and may even choose to impose annual or multi-sunth "seasonal" variations of temperature and humidity in order to accommodate vegetation with seasonal fluctuation requirements for germination and fruiting, etc. Differing choices of climate and degrees of seasonality will lead to a distinctive ambiance for each. The resultant differences in flora (and fauna) may help protect against the spread of plant diseases between settlements. It should also help promote intersettlement tourism and trade in distinctive flora and fauna based products.

Seasons & Urban Wildlife

Some insect, birds and mammals have mating and birth or hatching cycles that are closely coupled to seasonal differences in temperature, lighting conditions, etc. It will be difficult to successfully transplant populations of such species to lunar settlements without reproducing or simulating such climactic clues and sequences. While some species are relatively omnivorous, others demand particular plant species for food, or even the presence of particular animal prey.

We will do well to look for animal species that are not only non-parasitic on the vegetation species we want to support but which are not that particular in their eating habits, and not that restricted in their life cycles by particular climactic and seasonal conditions. In

other words, we will want to pick insects (bees, butterflies, etc.), birds, pond and stream fish, and small mammals that adapt well to a great variety of conditions.

Some we will want to complete our ecosystems, others for food production or agricultural needs, others for just plain enjoyment (butterflies, hummingbirds, song birds, goldfish and koi, even squirrels.) One man's pest is another's delight. Which will do best may depend on the type of climate and seasonal variation that is being reproduced or simulated. Thus the "wildlife" in one settlement may well differ from that in another.

Some transplants may be successful from the very start. Others may require a bit of trial and error experimentation. The basic challenge, however, remains: how do we harmonize any seasonal rhythms desired plants and animals may have with the sunthly climate swings of alternating two week long dayspans and nightspans, sure to be reflected in habitat and farm area temperatures and light levels. We can wait until we get there, or take advantage of whatever opportunities may come our way to experiment here and now with terrestrial market needs subsidizing the cost of the experiments, as in the Raspberry Production story reported above. The lessons learned in that case are a perfect example of serendipity. Now that we see what can happen fortuitously, it behooves us to be on the lookout for more such opportunities for dual purpose research.

We need an experimental agriculture team that would be on the lookout for just such opportunities. <MMM >

MMM # !65 MAY 2003

Settlement Garden Tours: A Favorite Frontier Pastime

By Peter Kokh

Why Settlement Gardens will be Tour-worthy

Without the multi-shade greens of the garden, without the bright colors of flowers and fruit, the gray monochrome color schemes enforced by available building materials will become dreadfully dreary. Public and private gardens will provide an ever changing feast of eye candy.

More importantly, lunar settlement will always be to some degree "provisional." Talk of returning to the Moon, or settling Mars, "for good" may be a statement of unanimous deep commitment, but without a planetary biosphere that could live on without our constant tweaking, our continued existence will always be "tentative" and dependent on our collective economic success and environmental "good behavior." In each settlement, all habitable spaces and structures will share a pressurized "safe house" and a shared mini-biosphere nourished within it. That human-installed biosphere will always be at risk, never be more than several months away from becoming a "ghost town." Lunans will know that and take it in stride, much as people survive day to day in areas where death by senseless terrorism is ever present.

Given the native barrenness and sterility of the Moons, nothing will be quite so comforting to most pioneers as vegetation and lots of it – greenery and flowers – and healthy crops of grains, fruits, vegetables, herbs and spices. At first, the number of successfully transplanted species will be small. The pioneers will be especially encouraged, heartened, and delighted with the establishment of each new species, whether it means a welcome addition to food menus, a source of natural dyestuffs, new fibers, medicinals, or just purely ornamental. The truth of the matter is that increasing biodiversity within the settlement biosphere will mean increasing strength and vigor, increasing resistance to environmental catastrophe, and progress towards a true biospheric "flywheel." But we are not talking just about what is needed to keep our bodies alive, but also about what is needed to keep spirits alive -- and productive.

Garden tours of noteworthy green spots, whether in the settlement farm areas, parks, streetside landscapes, or private homesteads stands to be a very popular and frequently indulged pastime. From year to year there will be more to see: new food crops, new landscape

plants, new flowers. These tours will work to instill a real sense of bio-spheric progress in both diversity and security. Pioneers will notice that more and more of “Gaia” has made the move outward with them. They will feel less and less biologically isolated. That they must also be making economic progress goes without saying.

Garden Tourists

Who will go on such tours? Certainly the local inhabitants! But also visitors from any other lunar settlements and outposts that may be established over time. For, as the Moon has no “climate” other than the 29.5 day long sunthly cycling of dayspan and nightspan, the various settlements and outposts may each choose differing types of vegetation and crops. These differences will help fuel intersettlement and interoutpost tourism -- and rivalries!

Some Earth tourists may want to do the garden circuits, but for many of them, there will be little to see that holds a candle to what they take for granted on Earth -- unless Lunans succeed in growing flower “forests” of especially tall plants in light gravity, a yet to be proven prediction of Arthur C. Clarke. No, the real reasons for garden tours will be to encourage the spirits and morale of the pioneer settlers, and to spur healthy competition and spin-off garden-based cottage industries and enterprises.

What’s to see on agricultural / horticultural tours?

What’s to see will change constantly. The Local Gardens Online magazine will post farm areas, streetside landscapes and plantings, and open house private gardens available for touring along with hours and other particulars. Download the self-guiding tour lists and hit the byways.

There will be rows and rows of crops in the agriculture areas, As the seasons can be separately controlled in the various farm areas, there may always be something in bloom, something ready to harvest or in the process of harvest. The season you are in the mood to experience may be but a walk away. Many agricultural areas may include picnic facilities and mini parks in their midst, respite places from the hectic pace of life and frontier stress.

Along settlement thoroughfares and byways, every plantable square foot put to good use, there will be beautiful landscapes and flower beds in every state of season. Even the lower part of curved cylindrical walkway module walls can be used for diversified terraced plantings without taking up flat space needed for walking. Some of these landscapes and gardens will be planted and cared for by garden clubs, rather than by the settlement municipality.

Water for garden use, even for ponds, fountains, and waterfalls in garden settings will likely be waste water in advanced stage of treatment. We can stretch limited water reserves much further if put it to work at every stage of the recycling loop. Both public and private gardens on tour will commonly have water features. Some will be unique enough to merit special notice in online tour guides.

Homesteads will be interconnected within a larger biospheric maze, each opening via a securable pressure door onto a pressurized “street” on the analogy of our terrestrial residential blocks. If these streets are sunlit at intervals, then these frontages are also opportunities for private gardens in public view, testaments of civic pride as well as personal pride of place.

On the Moon or Mars where surfaced “lots” are barren and lifeless, the “front yard” and “garden” has to be interiorized, located in the “reclaimed” space within the pressure hull complex. It is likely that many, if not most (or all) modular homesteads will include indirectly sunlit interior garden spaces. Private homestead gardens bring many advantages: interior air quality; point source treatment of toilet wastes; supplemental herbs, fruit, and vegetables; garden stuffs for cottage industry income; the delight of greenery, flowers and garden scents; pools of sunlight; the reassuring contrast to sterile moonscapes out the window; and more -- in sum, a psychological security blanket.

Not all private gardens will be tour worthy. Even the best of them will merit a visit only at certain times. Nonetheless, home garden tours on the Moon and Mars may be every bit as popular as they are in our own cities and suburbs. Here we will find more varieties of plants, greater diversity of design, and something special: garden products for sale, some not be available anywhere else: jams, jellies, pickle relish, herbs & spices; wood jewelry, home crafted

paper art and products, etc. The list of potential garden-derived cottage industry products is endless. Times, locations, descriptions, specialties can all be advertised online in a common Garden Tour watering hole website.

Adding to the treats of greenery, flowers, and garden design, will be the sights, sounds, and smells of water features. Delighting many will be the sights and sounds of the vegetation-hosted urban wildlife hosted: song birds, hummingbirds, butterflies, bees, fish, and other creatures.

We can expect many stands selling garden produce and products: fruit and berries and jams, jellies, and pies; vegetables and other salad stuffs and salads; herbs and spices and dyestuffs; specialties not available from settlement farms such as coffee, tee, hot peppers, and more; gourds, dried flowers, home made craft papers, baskets, mats, and wreaths; seeds, shoots, sprouts, bulbs; how to books, garden tools and apparatus; home made fertilizers and other soil amendments. All of these things, the result of a healthy homestead garden-based cottage industry.

Garden tour traffic will be inviting to other entrepreneurs, artists and craftsmen as well, and there will be home made glassware and ceramics and other non garden-based creations for sale as well. And music, both canned and live! Add food and drink in great variety. Truly, there will be no better way to take the pulse of an increasingly thriving settlement than by making in the garden rounds.

In sum, on the frontier, interiorizing the biosphere will become not only public practice, but also second nature for each pioneer. Children will grow up with the biosphere instinct and be green-conscious, freshwater conscious, fresh air-conscious. Settlements cannot survive long term without a culture of greening wherever possible. While not all of us have green thumbs, most children can learn how to care for plants, and learn to enjoy doing so.

Trees in Lunar Settlements

In 1990, a student working on the NASA grant Genesis CAD [computer assisted drafting] Project for Lunar Base & Habitat Design at the U. of Wisconsin-Milwaukee's Dept. of Urban Planning and Architecture, produced an interesting plan in which his base design was capped by a dome "to provide a place for trees". A NASA auditor excitedly protested that there was no way we could afford to waste space in such fashion. The student, unabashed, replied that if there were no trees, it would not be a human place, a place fit for human habitation; he stuck with his design.

This little anecdote illustrates a real dilemma. Even if the costs of space transportation fall, spaciousness will still be at a premium until we begin to build expansion shelter from local building materials. But even with locally produced housing, pressurized areas will still tend to be close-ceilinged, without tree-scale headroom; for the Nitrogen needed as a buffer gas to pressurize extra volume may well be a costly import.

Yet the student's observation is quite on target. Without trees, we'll have only a caricature of a human place, despite the fact that in some desert and plains areas, people do now live without them. Trees are essential to the functioning of Biosphere I (Earth!) Second to oceanic algae and phyto-plankton, Earth's forests make the greatest contribution to the sweet oxygen necessary to all higher life forms, single cell on up.

What place will trees have in the mini-biospheres of the Moon and Mars? Their ornamental use in landscaping will be minor. Yet, for frontier agriculture, trees would add greatly to the variety of fruit, syrups, pulp, fiber, and artstuffs etc. - purposes that are less easily satisfied by smaller plants or bushes. But tree "dwarfing" by nursery breeders serving home gardeners has made much progress. Settlement orchards may feature short but fruit-laden apple, orange, pear, peach, and cherry trees, etc.

"Arboriculture" is one radical proposal to grow nothing but ultra-fast growing trees on lunar or space settlement farms, harvest them for pulp to feed vat-cultures of microorganisms to transform this fodder into synthetic foods of every imaginable taste and texture. This pseudo "Soylent Green" may well be the most efficient way to do farming on the space frontier.

Bonsai miniature trees can provide ambiance for early pioneers. The Japanese have long cultivated the art of dwarfing trees by controlled pruning and fertilization, grown them in small pots into caricatures of older, bigger trees. Evergreens, leafy deciduous trees, vine and fruit-bearing varieties are all successfully miniaturized. Waist-high setback platforms in passageways can be lined with Bonsai forests. <MMM>

MMM # 175 MAY 2004

Creating “Nature Walks” on the Moon

By Peter Kokh

Perhaps most of us have been somewhere in the countryside, mountains, forest, desert, shoreline, and have noticed a sign “Nature Trail” and decided to talk the plunge. Chances are we will have enjoyed it, and if we took the time to read all the signs attempting to inform us about what we were looking at, emerged with a bit deeper insight into nature’s wonders and mysteries.

Some Nature Trails may point out a few geological features such as rock outcrops, waterfalls, and so on. But by and large, most of our Nature Trail educational tidbits are about flora (plants) and fauna (animals.) We tend to take the host geological setting for granted. And precisely because there seems to be a so much greater wealth of detail to wonder about and to delight in when it comes to plants and animals, the subtle differences in texture and color of rock and soil are at best, enjoyed as is, with no felt need to learn names, classifications, or significances. We simply take the inanimate context for granted.

I think on the Moon it will be different. Yes, we will have flora and fauna nature trails, but inside human-created mini-biospheres. Out-vac, on the barren lifeless surface, Nature Trails through the “magnificent desolation” will have only geological items to highlight and educate us about.

We do have a primeval need to identify salient things and details in our environment. It is the Adamic urge to “name” things. In the absence of visually distinctive plants and flowers and birds and other creatures to identify and “tag” with a name, I think our attention will automatically shift to subtle differences in the inanimate setting that we would not have paid attention to if plants and animals were present. Nature abhors a vacuum, goes the old saying, and so does the mind. The way this rock is shaped and textured and colored differently from that one will take on new significance and importance, in the absence of other things upon which to focus.

An Analog Moon Nature Trail Experience

This was all brought home to me most vividly in the summer of 1992, when, as the guest of Bryce Walden and Cheryl York of the Oregon L5 Society, I had a walk (and at one point, crawl) through tour of the pair of lavatubes that, at that time, constituted the “Oregon Moonbase” just outside Bend, Oregon. Being rather familiar with limestone caves full of interesting stalactites and stalagmites and other water-flow and drip-created features, I had expected a tube created by flowing lava to be rather uniformly devoid of interest. But I was amazed to see how the texture of the lava-flow-formed walls varied from place to place. I counted at least eight distinctive surface types. I felt the need to be able to identify this texture from that one and to understand what caused the differences. These details are things I may perhaps have noted, but paid no more attention to in a setting with plants and/or animals in the foreground to hog my attention. And there we have it. Geology for most of us remains in the background, because the living foreground pops out and monopolizes our awareness. Absent life, the geology becomes the foreground and zooms into focus.

On the Moon

When we look at Apollo Moon mission footage, we notice differences, but perhaps do not dwell on them. The scene seems desolate at monotonous. Hello! There are no plants and animals – things we are used to seeing most everywhere on Earth. But for the Lunan pioneer,

once the ingrained expectation of living entities no longer fogs our interpretation of what we see before us, I think we will start noticing this and that about the moonscapes – the subtle yet somehow interesting differences between this view and that, between this location and that. In the absence of other things to “recognize” by name, we will want to know the name of this feature or that, and in the absence of that information, start creating names from scratch.

A lunar settlement will soon create nature trails through areas in which there are a variety of features that are noticeable, and about which the history of their formation, the mineralogical, and potential economic importance will be of interest (again, lacking anything else – read: living – to focus upon).

With the best of attitudes towards the Moon, most of us, given the chance to take a coach tour on the Moon, will become a bit bored after a few hours or miles. We don't appreciate the distinctions in what we are seeing. Consider these parallels on Earth. In the absence of the cultivated ability to see and appreciate differences, “when you've seen one waterfall, mountain, or city you've seen them all.” Boredom is not without guilt. It comes from failure to cultivate an appreciation of distinctions and differences.

In the near and not to distant future

Nature trail education will help Lunan pioneers and visitors to enjoy what they see more thoroughly. But why wait? In the very near future, any of us will be able to go to the nearest IMAX theater and enjoy as never before possible, in wraparound attention-captivating detail, the moonscapes actually photographed by the Apollo astronauts, thanks to Tom Hanks and his crew and Lockheed-Martin. Look for “Magnificent Desolation” to open soon, and go see it again and again. See MMM #174, APR '4, p. 12

And why not fly a photographic lander-rover to an interesting spot on the Moon, do a lot of videotaping, and have Moon geology experts edit the footage for the more interesting and significant items, and with the help of science popularizers, create a DVD or IMAX Nature Tour of this or that moonscape we can all enjoy while stuck here on Earth. In the process we will be learning to appreciate the subtleties, and find the Moon a much more interesting and intriguing place. <MMM>

MMM #176 JUNE 2004

National Parks on the Moon

By Peter Kokh

World Book: [a] **National park** is an area set aside by a nation's government to protect natural beauty, wildlife, or ... places of cultural, historical, or scientific interest. ... Governments create national parks to guard their natural treasures from the harmful effects of farming, hunting, logging, mining, and other economic development.

The world's first national park, Yellowstone National Park, was established in the United States in 1872. National parks gradually spread throughout the world. Today, about 1,500 national parks [exist] in more than 120 countries.

The Moon is “virgin territory,” -- well, almost. Intact artifacts left behind by the Apollo manned Moon landings and various robotic missions are destined either to be part of future Frontier Republic historic National Monuments or to be relocated in Lunar museums.

Now is clearly the time to think and act ahead about preserving and protecting some areas of the Moon of especial geological interest or scenic beauty by setting them aside as, for now, International National Parks (to be transferred to the Lunar Frontier Republic as the latter emerges as a de facto civil authority).

There are at least two steps here. The first is the creation by international treaty, provisional classes of lunar “national parks,” and a set of “protocols” which would protect them from economic and industrial development, allowing or disallowing road development and

commercial “concessions.” Of course, once jurisdiction passes to the local frontier authority (a stepped process which should be milestone-driven and established beforehand by treaty to remove it as a political and power-play issue,) that authority would have the right, limited and defined in its own constitution, to review and reset any such protocols.

The second step is the nomination by an international committee of self-selected geologists and other scientists, tourist industry panels, commerce and industry representatives, and interested individuals of specific features or regions to be so protected. This list, to be an “attachment” to the original treaty establishing a Lunar National Park System, could always be added to later on.

For both of these steps, there will be considerable disagreement. Some will want to guarantee the treasured sites on the originally list from any and all human encroachment, while others will seek more pragmatic provisions. A reasonable compromise would be to create classes: class A containing the most protected, class C those only minimally protected. Some will favor only a few original parks, others will want to preserve half the Moon or more. There will be wide differences of opinion on the merits of individual areas to be selected for the original list. But it should be possible to find broad agreement on a starter list, and compromise positions on the protocols governing them.

Mining & Processing Industry Protocols

We have previously pointed out that “Moon mining” is not likely to be an especially “scarring” operation. The elements we need are to be found in the already “pre-mined” impact-pulverized debris blanket of rock and powder, meters-thick, that covers the entire lunar surface: the “regolith.” That said, we can split mining operations into those seeking to “produce” elements found just about everywhere or, at least rather widely [oxygen, silicon, iron, aluminum, calcium, titanium, magnesium – all in parts per hundred; others found in parts per ten thousand] and those concentrated only in a few atypical areas. Clearly, any mining activity seeking elements in this first classification, since it can be done most anywhere, can be completely forbidden within the selected park areas and their approaches.

Any rare and strategically needed elements which are especially concentrated in an area nominated for inclusion in the Lunar National Park System, could be mined within the area in question, in a tightly regulated “clean” operation, and then processed elsewhere. What we have in mind is the possibility that we would discover that a protected impact crater area is of the Sudbury (Ontario) type, rich in asteroid-endowed metals otherwise absent on the Moon in economically producible abundances, such as copper, zinc, gold, silver, platinum – all industrially strategic. Lunar geologists have yet to identify any such “heaven-blest” area, it is possible one or more may be identified in the future.

Tourist Industry Protocols

Some areas, chosen for inclusion on the original list for their especial noteworthy geological features, might also be identified as having especial scenic value. Others areas of no unique geological interest, may be nominated for inclusion on the merits of outstanding scenic appeal alone. In either case, if we are not to be left to “tour” them at the end of an Earth-bound telescope or from the porthole of a passing spaceship, we need to consider public access.

Access can be restricted to guided “Eco-tours” aboard “self-contained” excursion coaches, or opened up to do-it-yourself self-guiding tours for individuals in private vehicles. The limited access provisions would apply to especially fragile sites and may include “pack it in, pack it out” regulations to guarantee that human detritus would not accumulate. An option, once traffic merits, would be excursions via suspended monorails or cableways, hugging the high ground where possible.

Once tourist traffic and volume grew to the point where it made sense, could allow and provide for carefully regulated tourist-serving “concessions” within the park area – hotels, restaurants, “general stores,” even RV camping grounds. If these operations could be conveniently placed at, or just outside, the park boundaries, that would be preferable.

Transport Corridor Protocols

Roads and trails are an important item to discuss. In some especially delicate areas, we may want to allow only a bare minimum of overland access, keeping the route as “rustic” as possible. For especially scenic craters, rilles, escarpments and other high vantage points, we may want to provide only scenic “rim roads” or scenic overlooks, with no access to the floor or area below other than by specially equipped go-anywhere, off-road vehicles that do not require intrusively bulldozer-graded routes. In a few cases, the Alpine Valley providing access between northern Mare Imbrium and Mare Frigoris for example, we will want to provide for a major highway, a minimum of traveler-serving concessions, and tightly regulated signage.

The merit of transportation access is obvious. How else are we to enjoy these treasures set aside for us? By browsing through a book or watching a DVD documentary? We could provide both, of course, for tourist wannabes and those selecting their itineraries. But for the future Lunans themselves, if not for Earthworms like ourselves, access is clearly in order -- access with thoughtful restrictions.

Some Park-worthy nominations

There are noteworthy areas, features of special scenic interest -- at least from our wrong-end-of-a-tele-scope vantage point -- in all areas of the Moon's surface: in the nearside highlands and maria; on the farside. As we do not know (although many are prematurely “sure”) where the first outpost will be sited, and where early and subsequent industrial settlements will spring up, it will be important to identify candidate sites all around the globe for protection. With my 12” globe of the Moon in hand, I'd like to start the list off with the following short starter-list nominations:

- Nearside craters: Aristarchus, Plato, Copernicus, Tycho, Theophilus, Proclus – there are equally outstanding craters elsewhere on nearside, that could be added to the list if settlement, transportation, or mining activities were to be considered nearby.
- Other nearside features: the Alpine Valley, Hadley Rille, the “interruptions” or “bridges” along Hyginus Rille, the Straight Wall, the Altai Scarp, the Rheita Valley
- Nearside historical sites: the Apollo Moon landing sites, the Lunakhod sites, any intact landers.
- Farside Craters: Tsiolkovsky is at the top of my list, Van de Graaf

Once the site of the initial international outpost is agreed open, worthy sites within reach should be identified and protected appropriately. One may argue, of course, that most places on the Moon are already protected by their very remoteness and inaccessibility. But the day may come, when many noteworthy places will no longer be remote and inaccessible. Establishing a Lunar National Park System infrastructure, even without a short list of first inclusions, would be a wise move for these reasons:

- It is easier to establish such a system now, when the threat seems remote, than later, when economic counter-interests may have arisen.
- Early establishment of a Lunar National Park System will be a media coup, thrusting the Moon and its beauty into the public consciousness.
- It will whet the appetite for lunar tourism, thus helping create the justification for development of the vehicles and systems needed for on-location tours.

Extreme Touring

As on Earth, some parks will get the majority of tourist visitors, being “on” the most popular itineraries. But also as on Earth, there will be a tourist market for those who wish to explore “off the beaten path” in remote or usually overlooked areas or in “virgin” territory.

First Robotic Tele-tours

The very act of establishment of a Lunar National Park System by treaty, along with a starter list of included areas, will lay the economic grounds for private enterprise to land robotic “tour guides” on location, to photograph and explore the especially scenic features with maximum “ooh and aah” appeal, to be included in edited tourist documentaries on video and DVD or in **National Geographic**, along with promotions of the sponsor tourist companies, of

course. Tourism “pump-primers.” A next step would be actual live tours, rehearsed or unrehearsed, exploring especially mysterious areas such as the first lavatube to be entered.

Flora & Fauna Preserves

When we think of “National Parks,” places of great geological and biological beauty come to mind: Yellowstone, Banff, Great Smokies, etc. Yet we too have preserved areas in which life is sparse, if not all but invisible: the Grand Canyon, Arches, Haleakala, for example. Biological preserves would seem to be out of consideration on the barren and lifeless Moon. But someday, that may not be the case.

In pressurized urban areas, we may set aside and designate as “wilds” areas left to be seeded at random by the birds, insects, squirrels, and ventilator winds, as an experiment and educational project spanning generations. We might also set aside areas to be landscaped and planted with trees and plants and wildlife of no economic importance at all, just for settler enjoyment and appreciation of beauty, and as places for peaceful retreat.

On a larger scale, heavily-traveled inter-settlement routes between neighboring population clusters may one day be relocated into pressurized tubes or rilles with broad fringe areas that can be planted with a mix of crops and purely ornamental plants -- parkways. And there may be small scale “national forests” created in pressurized structures by private enterprise seeking tourist dollars.

A Lunar National Park System will have a profound impact of the way lunar settlement develops, and even on its pace. The time is ripe. Let’s get started! <MMM>

MMM # 179 OCTOBER 2004

Trash >> Treasure = Trashure
Waste >> Resource = Wasource

Trashure Creativity & Wasourcefulness: Two Critical Talents on the Space Frontier

By Peter Kokh

A shining example

There are many people who make their living, and many more who supplement what they can buy from day job wages or salaries by rescuing things others have thrown out as trash. They/we (for I am surely one of the later) reuse some things as they are, refinish other things, and find wholly new uses or adaptations for still other items. The practice of turning Trash into Treasure (“One man’s trash is another man’s treasure” has so long been a part of our culture that the hybrid word “trashure” is now well established as a search engine exercise will demonstrate.

Yet it is certainly the case that most people are not up to speed on this -- perhaps they lack the spirit of creative adventure involved in “dumpster diving” and the thrill of acquiring, for little effort or money, something to treasure in their homes, or perhaps they can’t be bothered to make the effort, or perhaps they disdain anything with a “history” or perhaps they have the cash to buy “new” (read unsullied.) Yet trashure is well-enough established to have become a respectable, even admired hobby.

On the Lunar and Martian frontiers, as on Earth, pioneer artists and craftsmen will find used materials and items their least expensive and most readily available option. It will pay for settlement citizens, individual and corporate, to presort discarded items and send them to a

Stuffs or Trashure Market where, hopefully, a good and growing percentage of it will be adopted for reuse, rehabilitation, or transformation into new utilitarian and/or decorative items. "Dumpster Diving," "alley scrounging," and "moving day curbside scavenging" will come out of the closet.

Creative and enterprising volunteers will turn this windfall into unique furniture and furnishings items, works of art (sculptures, for example), musical instruments, toys, and even personal adornment jewelry items -- for personal use and for sale. The trashure industry will grow as the amount and variety of discard items increases, becoming a significant complimentary sector in the overall economy.

Everyone will benefit, as this activity will significantly expand the variety of locally produced items. Visiting trash stuff markets, flea markets, arts & crafts fairs, and specialty shops filled with born-again items on consignment will add weekend pleasures to spare time menu options.

Front End Trash Reduction Measures

Not all pioneers will have the creative talent and urge to make use of the flow of trash. If the volume of discarded items and materials is not to swamp them, up front measures will be needed to reduce the sheer amount of stuff finding its way to the general pile. Here are some simple measures that will help (that some of our spoiled manufacturers may be temporarily inconvenienced by having to switch philosophies and gears should not dissuade settlement fathers from insisting on these protocols.)

Using KD (easy "knockdown" or disassembly-friendly) methods of assembly, especially when dissimilar materials best recycled separately are involved. We are used to dissimilar items being permanently "bonded" by adhesives, and thus mutually contaminating one another as far as economical recycling options are concerned. a tax break on items so manufactured, calculated by special rates for kind of material and strategic value. a turn-in credit reward for consumers and manufacturers (who may discard unworkable seconds) discarding items in a properly sorted and disassembled state University involvement through a department of Industrial Engineering, in searching for designs that make secondary adaptive reuse relatively simple. Containers that can be reused as canisters, as stackable dresser drawers, as planters, etc.: [The "world bottle" was an inconclusive project in the 1970s to design a beverage bottle that could be used as a building brick.] If there are sufficient incentives, manufacturers will be motivated by profit to create items, normally for one-time use, that can become "pop" stuffs for all sorts of uses. We'll revisit this idea in a future article.

The same strictures should apply to the construction industry. Methods that make separation of materials that need to be recycled separately (i.e. metals and organics) all but impossible such as adhesives (yes, Liquid Nails) and staples, should be taxed sufficiently to provide the money (and labor) necessary to undo these difficult bonds, especially when organic or synthetic materials that embody elements scarce on the Moon (hydrogen, carbon, nitrogen, but also some metals such as copper, brass, zinc, lead, gold, silver, platinum.) KD! KD! KD! The tax should be sufficiently onerous to make KD assembly methods more attractive. Think of those who follow, if what you build or put together is not meant to work or perform forever!

Extending the paradigm: packaging waste

In MMM #4, April 1987, "Paper Chase II" (www.asi.org/adb/06/09/03/02/004/paperchase2.html) we speculated about ways settlers could do without paper. Paper as an agricultural byproduct should be reserved for quick-turnaround uses: art du jour or temporary children's art, for example, where it can easily and routinely be recycled back into the biosphere-biomass cycle. On Mars, where the stuffs of organic compounds (hydrogen, carbon, and nitrogen) are comparatively abundant, such stringent restrictions may not be necessary (but still wise!)

Paper and cardboard and other packaging materials constitute one third of the total volume of trash and rubbish in modern America. On the Moon, packaging will preferably be made of inorganic materials (e.g. wire mesh bags and baskets, foil, "tin" containers, etc.) or will

be formulated and/or designed for easy craft reuse, especially as media for developing artistic talents in children.

There are many other suggestions in the article mentioned. The packaging nightmare has been greatly exacerbated in recent times by having to resort to shrinkwrap cardboard packaging for small items previously held in open bins, as a shoplifting counter-measure. Hopefully, the settlers will come up with other means of discouraging shoplifting in order to do away with this wasteful use of paper and plastic based materials -- but something short of Plastics.

Plastics

Most of our plastics are coal- or petroleum-derived. But there has been considerable effort in the past few decades since the first Oil Crisis, to derive suitable organic feedstocks from "oliferous" plants. Those who would pioneer the Martian Frontier are looking for even more direct routes, synthesizing basic plastics feedstocks like ethylene and propylene directly from the carbon, oxygen, nitrogen, and hydrogen in the Martian atmosphere. Their success will be of use to Lunan pioneers as well, though without such an atmospheric reservoir of needed key elements. Import shipment "dunnage," the "co-imported" shipping container stuffs such as barrels, crates, skids, separators, dividers, and cushioning materials, will be a primary source of simpler plastics such as polyethylene and polypropylene that can be reformed and reused over and over again, if separately recycled. Current plastics recycling is mostly limited to those containers marked 1 or 2 (inside the recycling triangle symbol). Other containers may be marked properly, but the market for their reuse is not strong enough to support active recycling.

On the frontier, it will be the best strategy to allow in (by import) only those plastics the settlement is prepared to recycle. Sub-varieties, color-coded both for proper sortation and for use in creating KD children's toys, could help expand options. We have written previously about Plastics in MMM #26 June 1989, "Toy Chest" and "Thermoplastics" pp 5-6. These articles will be republished in MMM Classics 3, as a free access pdf file, in January, 2005. Also relevant is the article "Stowaway Imports" in MMM #65, May 1993.

Mining Wastes & Byproducts

Mining wastes include tailings, piles of gravel and other solids leftover after the extraction of the sought for element or ore out of the host soil or rock material. Also a problem is unrecycled reagents or acidic leachings dumped into ground water or drainage basins. On Earth, we can try to handle such problems by fines, but a far more effective way is to promote the identification, with University assistance, of profitable products that can be made of such unwanted materials and wastes, and/or profitable markets for sale of such byproducts as is. It can be more profitable to sell byproducts than to discard them. But product and market development must be aggressively pursued.

This kind of thinking and these kinds of processes need to be incorporated in the drawing board stage of development of lunar industries and their diversification. New products from what would otherwise be wasted will mean a more diversified supply of products for domestic use on the Moon, but also a more diversified portfolio of products for export to other in-space markets. Making use of tailings, used reagents and leachings is best seen as a great opportunity for Lunar enterprise, rather than a burden that erodes their profit margins. Those without the right attitude should be discouraged from getting involved.

Tailings will be the host regolith minus the extracted element or suite of extracted elements. The flip side of the coin is that tailings are now "enriched" in all the elements not extracted! That makes tailings a potential feedstock for other materials.

Tailings that are of no further economic use, can perhaps be reused as aggregate for lunar concrete, paving material for lunar roads, and sintered into building materials for unpressurized vacuum exposed structures such as shade walls and radiation-shielding canopies or ramadas for storage purposes.

The tightest possible recovery and recycling of organic reagents and acid and heavy metal leachings will be a cornerstone of lunar industrialization. Given the tight supply of

hydrogen, carbon, and nitrogen, and the need to reserve as much of that as possible to support the maintenance and growth of lunar settlement biospheres, no other policy makes sense, either environmentally or economically.

Manufacturing Wastes & Byproducts

Manufacturers will operate under the same environmental and economic common sense constraints. Material left over from extruding, casting, or machining parts will have to be recycled back into the source bin. Material contaminated by machine oils can be cleaned in house or shipped out to a service provider. Shipping containers that cannot be reused, will either be turned into sideline products or sold on a web-based byproducts and waste materials market. Most of these materials will be reused domestically on the Moon. But some may find viable export markets, further improving the Moon's import-export equation and overall economic viability.

Consultants will suggest new uses for manufacturing byproducts and waste materials will become a key player in making the lunar industrial system work well. Some of them may even take over a customer-approved plan as prime contractors. Bigger manufacturers may have in-house research departments doing this, spinning off subsidiary enterprises in the process. Waste reduction and recycling will be good business.

Agricultural "Wastes"

Once I was told by an expert in space agriculture that cotton was not a candidate plant for lunar agriculture. Despite the fact that no other fabric is as versatile, comfortable and recyclable, there is too much waste biomass involved. Fully 86% of the plant by weight is of no use. The statement, expert source or not, is absurd. One has only to look at the example of the African-American agricultural pioneer, George Washington Carver, with well over a hundred patents to his name on products that could be produced from the peanut plant. What Carver did in Tuskegee, Alabama should be a challenge to would be lunar farmers and farm product processors. That example could inspire a considerable diversification of lunar agriculture-based industries and enterprises. But even should future Lunan processors have less luck with cotton, it remains true that biodigesters have been demonstrated that can take any and all waste biomass and reduce it to an edible tofu like product, with only 2% stubborn waste.

Liquid and Liquefied Wastes:

A Plumber's point of view As a jack of all home-improvement trades, plumbing among them, I believe a lot of problems and challenges can be minimized by proper plumbing. In MMM #40 NOV '90, "Cloacal vs. Tritreme Plumbing" I described our present municipal plumbing systems, descended without substantial improvement from that of the ancient Indus Valley town of Mohenjo-Daro c. 2,500 B.C., as "cloacal." A cloaca is the discharge system used by monotremes (one hole), primitive mammals such as the duck billed platypus, in which the anus doubles as ureter. "One hole serves all." "One drain serves all." Nowadays some cities are belatedly trying to separate storm sewers from sanitary sewers. Too little, too late.

On the Moon, where we have a unique opportunity to design our infrastructure from scratch on a clean drawing board, we can institute polytreme, multi-hole multidrain systems to minimize the treatment and recycling challenge. Agricultural run off, shower and sink run off, toiled wastes, manufacturing waste water - these can all be plumbed separately, minimizing the problem instead of compounding it. If we start off on the right foot right away, this way of doing "business" will not be seen as a burden, but as the only civilized way of doing things, implying derision of Primary Point-Source Treatment

Rigorously separated polytreme drain and sewer plumbing systems will make the job of finding market worthy products derived from properly separated wastes that much easier. And even this challenge will be minimized by primary Point-Source Treatment. Biological gray water treatment of human wastes, more on the model of the 20 year plus field-tested Wolverton Graywater System (www.wolvertonenvironmental.com/ww.htm) which provides the home, office, restaurant or other toilet hosting, modules or structures with fresh sweet air (regenerating oxygen from carbon dioxide), abundant greenery, and sunlight than on the workable but laboratory-like GreenHab system installed at the Mars Desert Research Station in Utah. Such

systems will enable synchronized modular growth of settlement biospheres because every new toilet-equipped unit, residence, office, commercial, industrial, or other, will be equipped to execute a 95% pretreatment of human wastes before the gray water enters the settlement municipal sanitary drain system. The central burden for both water and air recycling will be enormously minimized. Waste waters from other sources can also receive primary treatment at the point source, again enabling the modular growth of the biosphere, with farming and industrial areas each contributing their share. Where does this put us?

Trash and rubbish are one thing. liquid wastes and sludges are something else, carrying the connotation of unclean and unsanitary, of polluted or even toxic. My point? If on Earth we can afford not to extend the same rehabilitation effort to liquified waste as we do, with growing frequency, to trash, that will not be the case on the Moon.

On Mars, the pioneers could probably get away with indulging the same bad habits we have on Earth. The difference can be summed up in one word: volatiles. Most wastes, especially liquid ones (with or without solids) are composed of organics; volatile elements abundant on Earth, and accessible on Mars.

On the Moon, these elements must be scavenged from solar wind gases trapped in the upper regolith layer or refined from comet-derived polar permashade ice deposits. What on Earth is useless and without value will be priceless on the Moon.

Toilet systems that use human wastes to feed plants are now demonstrated. Entrepreneurs have learned to use drained motor oil as fuel for heating. But most organic wastes are just "wasted." The Lunan pioneers will need a whole new attitude towards all kinds of organic wastes from human wastes, to food production and preparation wastes to chemical plant wastes. They will need to do the mental flip flop that equates waste with potential resource. Waste not, want not! It's not just for the dinner table anymore. This kind of frugality is an investment in the future.

To promote the idea, first among potential Lunan pioneers, then among our terrestrial brothers and sisters, we offer the trashure-parallel coinage: waste + resource = wasource pronounced "WAYsource".

Wasources must be integrated into the Lunar Resources pantry. Wasourcefulness must become part of their frontier culture, an aspect of settler resourcefulness. The frontier government can offer incentives to entrepreneurs and established companies alike to develop nontrivial uses for various types of waste. An Internet-based waste meta-nventory database and exchange program could be inaugurated. A frontier university should be very much involved both in maintaining the system, in expanding the categories as needed, in research and development of new processes and product lines, and in waysource-based enterprise creation and assistance.

Wasources represent invested hydrocarbons and other organic and synthetic enabling elements. Chemical feedstocks for plastics, lubricants, even pharmaceuticals are among the rewards. The volatiles involved will either have been brought from Earth as food stuffs, agricultural nutrients and fertilizers, medications, chemical reagents.

Some will come from routine gas scavenging of the solar wind gases in the regolith. Much of this will find their way through the human digestive track. Some of it will be waste byproduct of various food and regolith processing and manufacturing orations. The salient point is that any volatiles embodied in wastes (of whatever kind) should be treated as an investment, an endowment that should continue to produce income - not be flushed into some never-never land out-of-sight-out-of-mind from which retrieval may be difficult and unprofitable.

Storing wasources

In designing a complete and efficiently organized storage system, thought must be given to storing waste liquid and sludges, carefully segregated according to source and gross chemical makeup. At least that should be a goal for priority implementation.

Before we get too far along in developing our initial beachhead outpost into an infant settlement, we will either be already recycling human wastes, hopefully near their individual

point sources as in the Wolverton toilet=plant bed system, or we will have chosen by default for the settlement to fail. But early on, before such systems are in place, we will want to store these wastes in durable containers from which they can be retrieved when we are ready for them. To do that, all we need is to put them in permanently shaded areas (under a shed will do) where their chemical wealth can stay frozen and inert. To do otherwise would be seen in retrospect as an act of treason against the future human frontier, much as the currently accepted practice of scuttling the shuttle external tank just short of orbit is likely to be so judged, if only for its seven tons of copper, each, of almost astronomical value on the copper deficient Moon.

Pioneering the Moon will take a whole new set of attitudes, if we are going to make it work to enhance the viability of human outposts on a hostile world.. Wasourcefulness is one of them. Fortunately, there is a subculture paradigm for inspiration: that of “trashure.” < MMM >

New lands were discovered by iron men in wooden ships,
Not by wooden men in iron ships.

Above all, listen first, and listen patiently, and at depth.
You cannot convert someone
if you haven't taken the pains to learn what buttons to push.

MMM # 199 – OCTOBER 2006

The Moon as Virgin Territory, “a world without a history”

By Peter Kokh

Apollo's leavings

Yes, “not quite,” given the six Apollo landing missions of 1969–72, or if you want to be even more strict, since the first Soviet Luna probe crash landed on the farside in 1959. But the astronauts were only on scientific picnic missions. They did leave some things behind, destined to be revered objects in the first Luna City Museum some day.

But in truth, no one has ever “lived” on the Moon, not even for a short time. The Moon is largely pristine, unchanged, still waiting to be given the life that it could not give birth to on its own.

The first 4,600,000,000 (4.6 billion in U.S. usage) year period of the Moon nurturing the nascent life on Earth through its gentle tidal forces, but not sharing in the epic of life itself, is about to end. Earth Life has reached its reproductive stage, having given rise to an intelligent species capable of sowing that life in places that it could not have sprung up on its own.

Treating a virgin world with “respect”

Will humans treat this world with respect? Will they be a thoughtful caring suitor or a rapist? Many people repeat the common objection that we will only end up trashing the Moon as we have trashed the Earth.

But there is a difference, more than one in fact. Here on Earth we enjoy life in an immense planetary **biosphere** which included the atmosphere, the hydrosphere (oceans, lakes, rivers, and underground aquifers) the sea bottom oozes, the top soils of the continents. We do the damage we do, because up until recently, we seemed to be able to get away with it. Our ancestors might suffer, but who thinks that far ahead.

On the Moon, and Mars too for that matter, it will be different. There is no planetary biosphere. We will have to create and maintain mini-biospheres within which to reencradle ourselves. And because they will be so small in relative terms,

we will find ourselves living immediately downwind and downstream of ourselves.

Our environmental sins will hurt us immediately. We poison our mini-cradle, we die/ It's as simple as that!

Mining and Manufacturing

The Moon's surface has been "gardened" or tilled over billions of years of meteorite impacts into a top-blanket of pulverized and powdered material from 2 to 10 meters~yards deep. This smashed stone stuff is called the regolith. The composition of the regolith is the same as the upper levels of the lunar crust. In some areas, material from the mantle, below the crust, has been thrust to the surface as a rebound from major blows: the central peaks of large craters, for example.

The point is that mining operations will on the Moon will consist principally of extracting elements from this surface blanket. No ugly strip mines. No deep shaft mines. At least we do not expect a need for deep mining. Our regolith "mining" will not noticeably scar the surface, perhaps not even from fairly close viewpoints, and are most unlikely to cause any changes in the Moon's appearance from Earth, except possible albedo changes: freshly harvested regolith may cause that terrain to be a slightly darker or slightly lighter gray. At very close range one would notice the absence of any small craters in the 1-2 meters~ yards range, as our equipment rakes them smooth. Larger craters would be avoided, by passed.

All our mining an manufacturing and packaging and unpackaging operations create byproducts not immediately useful. But all these items represent some real amount of energy already spent. It makes sense to warehouse them, sorted by kind, so that when we come up with a plan to use in new ways, they are easy to find and gather. Mine tailings and processing slag might be used for low-performance building products: bricks and blocks and tiles and slabs, etc. or even cast into ceramic like household items. With a proper reuse-friendly warehousing policy, nothing will be discarded to "trash."

Garbage

As to food and biomass wastes and other organic residues, we cannot afford to dispose of them as garbage because they are made of precious hydrogen, nitrogen, and carbon – all present on the Moon but in amounts that count as "traces" when compared with their rich abundance on Earth. All these items must be recycled into the atmosphere, "religiously."

Architectural Visual Impact

The most likely form of settlement architecture will not be the dome-enclosed city popular with science fiction artists, and so structurally impossible.(The air pressure inside, with only vacuum above, would quickly rip the dome off its foundations and blast it into the sky.) Rather, in the near term, we are looking at ever growing mazes of interconnected habitation and activity structures, covered with mounds of regolith shielding. Apart from protruding antennae and heat-rejecting radiators, the view from above will be an orderly maze of mole hills.

Now while such settlements would blend into the landscape reasonably well, at least in color and texture, it need not remain so. Individuals may wish to give their own cozy homestead a special appearance. A dusting of titanium oxide or calcium oxide (lime), both easily made from mare and highland regolith respectively, would put their homestead mound in the "limelight." One covered with iron fines exposed to steam would give a rust hue. Or one could gather moon rocks and breccia and cover the surface of their mound with them. The options are quite a few. The point is, that they all involve lunar materials and are lunar-appropriate treatments.

For more on this topic, read MMM #55, May '92, p.5 "Moon Roofs" – republished in MMM Classic #6, a free download pdf file from either of this location:

www.moonsociety.org/publications/mmm_classics/

Also read MMM # 137 AUG 2000 "'Taking-back-the-surface' Architectures" – reprinted in MMM Classic #14, a free pdf download, locations above

Transportation systems

As additional outposts and settlements and remote mining operations are started, a network of lunar highways will grow to connect them into a marketing network. One of the things we can do now, or fairly soon, given much improved topographic/altitude mapping of the Moon is to determine contiguous areas within which surface transportation encounters no obstacles that need significant cuts, fills, bridging, or tunneling. The next task will be to find the easiest to construct routes that link these areas without considerable detouring. Surface roads can be self-paved, i.e. graded, compacted, and sintered with microwaves to “fix” the dust and powder content. Stones and boulders can be simply plowed aside, or to the median strip, to make route identification easy.

We’ve talked about road building several times, most recently in MMM #169, October 2003, pp. 4-7, “Early Frontier Highways on the Moon” (at the end of this article is a list of related articles in previous issues #s 37, 79, 81, 82, 85, 86 reprinted in MMM Classics #4, 8, 9.)

Of course, we will have small local, and larger regional spaceports. What we won’t have is airports! It could very well be that the workhorse of long distance cargo and passenger hauling may be done by lunar railroads. This may seem anachronistic. Railroads on a world of the space age? Why not? Check out

http://www.moonsociety.org/publications/mmm_papers/rr_moon.htm

But they will blend into the moonscapes as well

We will need intermittent flare shelters along lunar highways and railroads. These shelters will be covered with regolith, so will blend in also.

Making ourselves “at home” on the Moon

Making ourselves “at home” means using building materials made from lunar materials. It means adapting our life and production schedules, our import and export schedules, and our global travel arrangements to fit in with the grain of the Moon’s natural rhythms. the long dayspans and nightspans, a sunth-based calendar. It means adapting to lunar cosmic “weather” and learning to deal with their new homeland’s harsh unforgiving aspects as if by second nature, as have all pioneers of the past. It means learning to express their artistic and crafting instincts in lunar materials. It means making do with a lunar-sourceable color pallet. It means creating new sports and new dances to take advantage of light lunar gravity while momentum stays unchanged. It means finding substitutes for familiar terrestrial products made of materials not economically producible on the Moon.

It means, in the end, becoming People of the Moon, and no longer People of Earth.

The pioneers will end up belonging to the Moon, just as we belong to Earth. And that, we think, means treating the Moon with respect. In short, the Moon will change those who settle her, every bit as much as they change the Moon. It will of necessity become a symbiosis.

Lunar History to come has already begun

Our robotic probes and human crews have left the first impacts and footprints on the Moon not caused by natural processes. It is **an Overture**.

We had long ago named many features on the Moon, of course, and since Apollo, we have named many more. The pace of naming will continue exponentially, once we are there, to stay, and not just at the end of a telescope. More importantly, there will be places associated with success, with failure; places of desperation, tragedy. conflict. And yes, their will be ruins. Surface features will be put to geologically unforeseen human uses. But all this will be done together, as the Moon and humans face a future intertwined. <MMM>

MMM # 201 – DECEMBER 2006

Beyond Our First Moonbase: The Future of Human Presence on the Moon

By Peter Kokh kokhmmm@aol.com

Beginnings

If all goes as planned, U.S. budget crises notwithstanding, mankind's first outpost on the Moon will start to become real around 2020, a historic event, that were it not for politics, might have happened decades earlier.

The vision outlined in **The Moon: Resources, Future Development and Settlement**, by David Schrunk, Burton Sharpe, Connie Cooper and Madhu Thangavelu is a bold one, showing how we could set up our first outpost so that it would become the nucleus from which human presence would spread across the face of the Moon.

NASA itself has such a vision, but the agency can only do what it is authorized to do. If the history of the International Space Station offers clues, NASA's official goal, which only includes setting up a first limited out-post as a training ground for manned Mars exploration and nothing more, will be under increasing budgetary pressures to slim down into something with no potential for growth at all. The intended crew size, the planned physical plant, and the capabilities that are supported, will all be tempting "fat" for budget cutters who cannot see, or appreciate, the possibilities beyond. This is the risk of publicly supported endeavors in space. It is difficult to get political leaders, and the public itself, to look beyond very near future goals. The chances that our first outpost will be born sterile cannot be dismissed.

But if private enterprise is involved and ready to take over when and where NASA's hands are tied, there could be a bright future for us on the Moon. Much of that promise may involve finding practical ways to leverage lunar resources to alleviate Earth's two most stubborn and intertwined problems: generating abundant clean power, and reversing the destructive pressures of human civilization on Earth's environmental heritage.

Cradlebreak: early lunar building materials

The Moon has enormous resources on which to build a technological civilization. But first things first. How can we break out of a first limited-vision outpost? A humble start can be made by demonstrating the easier, simpler ways to start lessening the outpost's heavy dependence on Earth. Oxygen production comes first. Close behind is hydrogen harvesting, whether from lunar polar ice deposits or from solar wind gas particles found in the loose regolith blanket everywhere on the Moon.

If we have access to basalt soils in the frozen lava floods of the maria, we can cast this material into many useful products. Not the least of those are pipes, sluices, and other components of regolith handling systems: cast basalt is abrasion-resistant. If we expand the outpost with inflatable modules shipped from Earth at significant savings in weight per usable volume over hard-hull modules, we can use cast basalt products, including floor tiles and tabletops to help outfit these elbowroom spaces. We can learn from a thriving cast basalt industry on Earth.

Experiments done on Earth with lunar simulant, of similar chemical and physical composition to lunar regolith, then repeated with precious Apollo moon dust samples, give us confidence that concrete and glass composites will be very important in any future construction and manufacturing activity on the Moon. We could make additional pressurizable modules from fiberglass reinforced concrete or glass composites. We can make spars for space frames and many other products out of these composites as well. The Moon's abundant silicon will allow us to make inexpensive solar panels for generating power. Production of usable metal alloys will come later. The Moon is rich in the four "engineering metals:" iron (steel), aluminum, titanium, and magnesium.

An Industrial Diversification Strategy with maximum potential for cutting dependence on Earth imports

The name of the game is Industrial "MUS/CLE." If we concentrate on producing on the Moon things that are **Massive**, yet **Simple**, or small but needed in great numbers (**Unitary**) so as to provide the major combined tonnage of our domestic needs, we will make significant progress towards lessening the total tonnage of items needed from Earth to support the expansion effort.

Until we can learn to make them ourselves, we continue to import the Complex, Lightweight, and Electronic items we also need, but which together mass to much less. It would be very helpful to the success of such a strategy, to design everything needed on the Moon as a pair of subassemblies, the MUS assembly to be manufactured locally, and the CLE assembly to be manufactured and shipped from Earth, both being mated on the Moon.

Simple examples are a TV set: works manufactured on Earth, cabinet on the Moon; a metal lathe built on Earth, its heavy table mount manufactured on the Moon; steel pipe and conduit on the Moon, all the fittings and connectors from Earth. You get the idea.

As the population of pioneers and settlers grows, and our industrial capacity becomes more sophisticated and diversified, we can assume self-manufacturing of many of those items as well. Making clear and steady progress in assuming an every greater share of self-manufacturing physical needs is essential if we are going to encourage both continued governmental support and attract every greater participation by private enterprise.

Paying for the things we must import

Seeing that Earth seems rather self-sufficient, and products from the Moon would be expensive, many writers have concentrated on trying to identify “zero mass products” such as energy, to provide the lunar settlements with export earnings. The need for exports is indeed vital. As long as the settlement effort must still be subsidized from Earth, there will always be the risk of unrelated budgetary pressures on Earth fueling support for those who would pull the plug on lunar operations.

Thus it is vital that settlers develop products for export to help them pay for what they must still import. Only when we reach import-export parity, will the lunar settlement have earned “permanence.” Permanence can’t be simply declared. Tagging NASA’s first moon base as “a permanent presence on the Moon” is in itself just so much empty bravado. If we do not begin developing and using lunar resources seriously and aggressively, the effort will fail of its own costly weight.

Now here is the point where many will balk. Yes, there are grandiose plans to use lunar resources to build giant solar power satellites in geosynchronous orbit about the Earth, or to build giant solar farms on both the east and west limbs of the Moon to beam power directly to Earth, and/or to harvest precious Helium-3 from the lunar topsoil or regolith blanket, a gift of the solar wind buffeting the Moon incessantly for billions of years, the ideal fuel for nuclear fusion plants. But none of these schemes will materialize right away. Meanwhile what do we do? Cannot anything the Moon might manufacture to ship to Earth be made less expensively here at home? No!.

But that does not matter. Earth itself is not the market. Developing alongside of an upstart settlement on the Moon will be tourist facilities in Earth orbit. And that is something the lunar settlement effort can support. Anything future Lunan pioneers can make for themselves, no matter how unsophisticated in comparison with the vast variety of terrestrially produced alternatives, can be shipped to low Earth orbit at a fraction of the cost that functionally similar products made on Earth can be shipped up to orbit. It is not the distance that matters, but the depth of the gravity well that must be climbed. It will take one-twentieth of the fuel cost to ship a set of table and chairs, a bed frame, interior wall components, floor tiles, even water and food, from the Moon, 240,000 miles away, than from Earth’s surface, 150 miles below.

Thus, in the near term, the future of Lunar Settlement will be closely tied to the development of tourist facilities, hotels, casinos, gyms, etc. in orbit. This sort of development will start to bloom about the same time as a lunar settlement effort starts to break out of an initial limited moonbase egg. But the linkage will become visible much earlier: it is very likely, that the first space tourist will loop-the-Moon, without landing, before the first astronaut since Apollo 17 in 1972 sets foot on the Moon. The Russians say that they can provide such a tourist experience, skimming low over the Moon’s mysterious farside, in just two years after someone plunks down \$100 million. That will indeed happen, and it will create a benchmark that others will want to follow, inevitably brining the price down for a ride to an orbiting resort.

The Moon from a Settler's Point of View

Magnificent Desolation? Yes. Harsh and unforgiving? That too. Alien and hostile? Of course! It has always been so from the time our ancestors on the plains of East Africa started pushing ever further into unfamiliar lands: the lush, dense jungles, the hot dry deserts, waters too wide to swim, high mountain ranges, and eventually, the arctic tundra. Judged by the pool of past experience, each new frontier was hostile, unforgiving, and fraught with mortal dangers .. until we settled it anyway.

Once we learned how to use unfamiliar resources in place of those left behind, once we learned how to cope with any new dangers, as if by "second nature," then the new frontier becomes as much home as places we left behind. Anyone raised in a tropical rain forest, suddenly transported to Alaska's north slopes, might soon perish, unable to cope. The Eskimo never gives it a second thought. How to cope with ice, cold, the arctic wildlife, the absence of lush plant life, has become second nature.

And future Lunans will reach that point as well Yes there is sure suffocation outside the airlock. Yes the sun shines hot and relentlessly with no relief from clouds for two weeks on end. Yes the Sun stays "set" for two weeks at a time while surface temperatures plunge. Yes the moon dust insinuates itself everywhere. The litany goes on and on. Lunans will learn to take it all in stride. How to take due precautions for each of these potential fatal conditions will have become culturally ingrained 2nd nature. The Moon will become a promised land to Lunans.

Making ourselves at Home

Even in the first lunar outpost, crew members could bring rock inside the habitat as adornment in itself, or perhaps carve one into an artifact. An early cast basalt industry, early metal alloys industries, early lunar farming, will all supply materials out of which to create things to personalize private and common spaces alike. Learning to do arts and crafts on the Moon may seem useless and irrelevant to some, but it will be the first humble start of learning to make the Moon "home." And so it has been on every frontier humans have settled.

We will also learn to schedule our activities and recreation in tune with the Moon's own rhythms. We'll do the more energy-intensive things during dayspan, the more energy-light, manpower-intensive things saved for nightspan. With no real seasons, the monthly dayspan-nightspan rhythm will dominate. The pioneers may bring some holidays with them, but will originate other festivities and both monthly and annual celebrations.

Getting used to lunar gravity will also help the pioneers settle in. They will quickly abandon trying to adapt familiar terrestrial sports, which can only be caricatures of the games of Earth. Instead, they will invent new sports that play to the 1/6th gravity and traction, while momentum and impact remain universally standard. Alongside the development of lunar sports will be forms of dance. Can you imagine how ethereal a performance of Swan Lake would be on the Moon? How many loops could an ice-skater do before finally landing on the ice? .

But they have to live underground, for heaven's sake! .

On Earth, our atmosphere serves as a blanket which protects us from the vagaries of cosmic weather: cosmic rays, solar flares, micrometeorite storms. If our atmosphere were to "freeze out" it would cover the Earth with a blanket of nitrogen and oxygen snow about 15 feet thick, and still provide the same protections.

On the Moon, eons of micrometeorite bombardment have pulverized the surface and continue to garden it into a blanket of dust and rock bits 10-50 feet thick. Tucking our pressurized outpost under such a blanket, will provide the same protection, along with insulation from the thermal extremes of dayspan and nightspan.

Will our outposts look like somewhat orderly mazes of molehills? To some extent, perhaps; but the important thing is that we do not have to live as moles. We have ways to bring the sunshine and the views down under the blanket with us. In the spring of 1985, I had the opportunity to tour a very unique Earth-sheltered home 20-some miles northwest of Milwaukee where I live. Unlike typical earth-sheltered homes of the period, TerraLux (EarthLight) did not have a glass wall southern exposure. Instead, large mirror faceted cowls followed the sun across the sky and poured sunlight inside via mirror-tiled yard wide tubes through an eight-

foot thick soil overburden. Periscopic picture windows provided beautiful views of the Kettle Moraine countryside all around. I had never been in a house so open to the outdoors, so filled with sunlight, as this underground one. At once I thought of lunar pioneers, and how they could make themselves quite cozy amidst their forbidding, unforgiving magnificent desolation. The point: yes, the Moon is a place very alien to our everyday experience. Nonetheless, human ingenuity will find a way to make it “home.”

What about us outdoorsmen?

While Lunans will find plenty to do within their pressurized homes, workplaces, and commons areas, many will miss the pleasures of outdoors life on Earth: fishing, swimming, hunting, boating, flying, hiking and mountain climbing and caving. The list goes on and on.

Yet some of these pleasures we may be able to recreate indoors, fishing in trout streams, for example. We will want an abundant supply of water, and waste water in the process of being purified can provide small waterfalls and fountains, even trout streams for fishing and boating. In large high ceiling enclosures, humans may finally be able to fly with artificial wings, as Icarus tried to do.

Out-vac, out on the vacuum washed surface, it will be more of a challenge. Present space suits are too cumbersome, too clumsy. We need suits that offer more freedom of motion, that tire us less easily. Then out-vac hiking, motor-biking, mountain climbing, and caving in lavatubes will become practical. Out-vac sporting events, rallies, races, and games will follow. As we learn to take the Moon’s conditions for granted, and to “play to them,” we’ll invent sporting activities that suit the environment.

Agriculture and minibiospheres

The idea of going to the Moon with sterile tin cans and a life-support system tucked in a closet with a few token house plants thrown in for good luck is absurd. As it happens, NASA has abandoned “Advanced Life Support.” Instead we have to approach creation of living space on the Moon as a mating of modular architecture with “modular biospherics.” Every pressurized module should have a biosphere component, so the two, living space, and life in that space, grow apace, hand in hand. The clues are not in the organic chemistry labs but in the many down to earth “back to earth” experiments thriving on Earth as we speak. Earth life must host us on the Moon even as it does on Earth, not vice versa. Lunar settlements will be “green” to the core. And we will feel at home.

One settlement, a world “doth not make”

The Moon’s resources are not homogeneously situated. A site handy to polar ice reserves will not be near mare basalts, nor iron and titanium rich ilmenite, nor vast underground caves formed long ago by running lava. As the lunar economy expands, we will need to establish settlements in a number of differently advantaged areas. And that will make the Moon a real “world.” Lunans will be able to travel elsewhere, get away from it all, experience cultural, artistic, archeological, and climate variations. Even as an outpost cannot be “declared” permanent, neither can a solitary settlement. No matter where we choose to set up shop first, we need a global vision. The authors have this vision, and their brilliant concept of a lunar railroad network illustrates that well.

Getting through the Nightspan

To many people spoiled by abundant energy “on demand,” the need to store up enough energy during the two week long dayspan to allow the outpost to not just survive the nightspan, but to remain productive is daunting. Yet all of human progress is built on utilizing various forms of power storage, starting with firewood. Even in nature, the spread and survival of species has turned on this point, from bear fat to squirreling away nuts. The problem is one of attitude. Those with the right attitude will find a way, many ways in fact. The same goes for managing the thermal differences between lunar high noon and predawn. Since we first began to move out of our African home world to settle the planets of Eurasia and the Americas, we have tackled harder problems. Those not intimidated by the challenge will lead the way.

The pattern emerges

Lunan pioneers will make progress in all these areas together: providing the bulk of their material needs by mastering lunar resources; becoming ever more at home through lunar-appropriate arts, crafts, sports, and hobbies; creating a uniquely Lunan culture. This process must start immediately. The first outpost should be designed to encourage, not discourage experimentation by those with the urge to create and fabricate with local materials. Things shipped from Earth should be designed and manufactured in MUS/CLE fashion, so that their simpler and more massive components, made on Earth can be replaced with parts made on the Moon, freeing up the original parts for reuse. Parts made here of elements hard to produce on the Moon, like copper or thermoplastics, will help spur infant lunar industry at a quicker pace.

The Necessary Gamble

It is predictable that NASA, however free the life styles of its individual employees, will continue to take a conservative stance on fraternization between outpost personnel. It is predictable that there will be an absolute ban on pregnancies. Yet, this is something that cannot be conveniently postponed. The only way to know for sure if infants born on the Moon will turn out to be healthy, is to see how the second native born generation turns out. Will they be fertile? Experiments with animals with much shorter life cycles will give us debatable clues. There is but one way to find out for sure. Do it! Take the plunge.

Official policy may be quite strict and allow no exceptions. But then individuals will take matters into their own hands. Confidence in this outcome will grow, if there are for-profit commercial outposts on the Moon.

As long as we play the "outpost game," and that is what it is, of rotating crews with short tours of duty, as long as we avoid allowing people to choose to live out their lives on the Moon, raising families, as nature dictates, we will not see the rise of a lunar civilization, nor real use of lunar resources to help solve Earth's stubborn energy and environmental needs in sustainable fashion. Human choices must be taken out of the hands of politicians and administrators afraid of conservative opinion. Nations may build outposts, but only people pursuing personal and economic goals can give us settlement. If history is any guide, that is exactly what will happen.

Antarctic outposts are a dead-end paradigm: no real use of local resources, no economic activity, no real society. For the Moon, we see instead, a real human frontier in which an initial small outpost will seed a self-supporting frontier of hundreds of thousands of pioneers in a number of settlements. Many of these Lunans will be native born, others fresh recruits from Earth seeking the promise of starting over, starting fresh, getting in on the bottom floor. Throughout history, those doing well stayed put. Frontiers have always been pioneered by the talented but "second best" seeking a more open future.

The Moon will become a human world. <MMM>

M O D U L A R

B I O S P H E R I C S

Making the most of pressurized pedestrian & vehicular corridors:

"Living Wall Systems" By Peter Kokh

"A **living wall** is a vertical garden. Plants are rooted in compartments between two sheets of fibrous material anchored to a wall. Water trickles down between the sheets and feeds moss, vines and other plants. Bacteria on the roots of the plants metabolize air impurities such as volatile organic compounds." http://en.wikipedia.org/wiki/Living_wall

While this is the definition in the most technical sense, experimenters have made living walls in which plants are in pots anchored to a wall in a staggered pattern. They have also found other ways to keep them properly watered, fertilized, and to recycle the drainage water.

Illustration 2 below is an example of the first approach, illustration 3 below the latter.

In a modular outpost, there will be connecting tubular passageways for pedestrians and small carts. Their curved walls offer an opportunity to increase the overall biosphere mass of a lunar outpost (real or analog) by integrating a living wall feature along one side, for the whole length of (each) hallway. This will be in addition to the biomass contributed in any Greenhouse modules and any in the habitat and activity modules themselves.

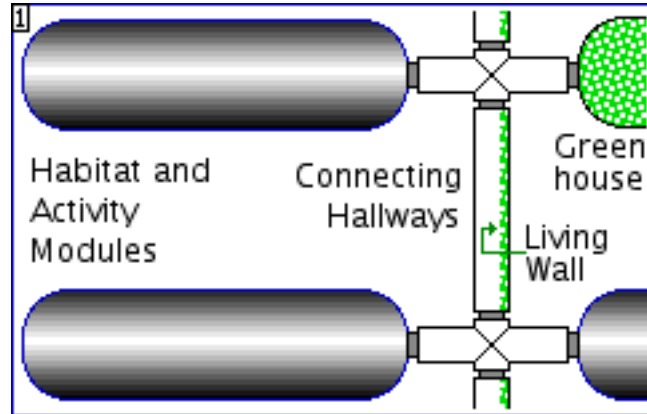

In a larger settlement, pressurized roads could have living walls to each side, and, down the middle, to separate traffic flowing in opposite directions, boulevard style. If we continue to think in terms of floor space, then we will be put in competition with the plants we depend on – not a prescription for success. But plant areas can make use of otherwise empty wall space. “Waste no opportunity to include more plant life, want not for your next breath” to paraphrase an old saying.

If we are talking about an open-ended installation (again, either on the Moon or at an analog research site) by adopting a policy that no wall should be idle, we guarantee that the modular outpost grows, a modular biosphere grows with it, neither outstripping the other. Now can there possibly be a better arrangement? Yet so far all biosphere experiments seem to be of set size, not designed to grow in modular fashion. The non-modular set-size approach tends to be an effective predictor that the installation will have no future.



Many Living Wall installations use a system of staggered planters and integrated water features to accomplish the same ends in a more natural and beautiful fashion.

Plants to choose from
There is a wide variety of plants that provide lush green foliage while cleansing the air of toxins (to prevent “sick-building syndrome”) and increase the amount of oxygen, maintaining a fresh, clean atmosphere inside.



R: Living Wall installation, Baltimore, MD. This 110 sq ft (10 sq m) wall filters all the air for its 7,500 sq ft office building. Notice the ornamental character of some plants chosen

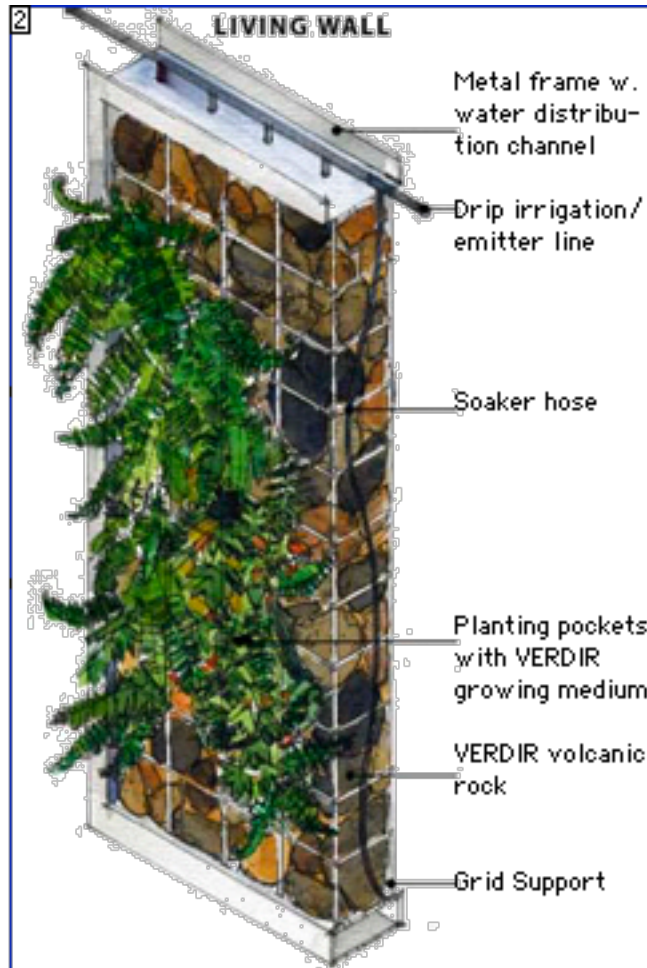

from www.verdirsystems.com/html/living-walls.html The above shows a technical approach.

Dr. B. C. Wolverton, doing the research for NASA, identified a dozen common house plants easily available that cleansed the air, including: gerbera daisy, bamboo palm, spider plant, marginata, mass cane, spathiphyllum, Janet Craig, and English Ivy – published in the pamphlet “Plants for Life: Living Plants Vital In Filtering Contaminated Air” – a NASA pamphlet published more than fifteen years ago.

Now Dr. Wolverton has published a much more comprehensive treatment in the book, “How to Grow Fresh Air: 50 Houseplants that Purify Your Home or Office” – Penguin Books ISBN 0.14.02.6242.1.

Living Walls as Graywater Purifiers

www.holon.se/folke/projects/openliw/openlev_en.shtml

“By growing plants in a porous wall [a special adaptation of the Living Wall concept, read on], you get both an efficient space use by vertical plant growing and purification of the percolating water, which can be grey-water.” (Graywater is water from sinks, tubs, and showers, and previously treated blackwater from toilets.)

“The hollow parts of the stones are filled with inert material, like gravel, LECA-pebbles, perlite or vermiculite. The stones are placed so the water will percolate in zigzag through the wall. Bacterials in the porous material break down organic pollutants. The water trickling down through the wall will nourish the plants at the same time as it will be purified. The plant roots will grow into the inert material and extract nutrients from the water. Over the pebbles, a bacterial film will grow. After consuming organic material they release the nutrients in the percolating water. The plants will take up the nutrients and subsidize the

bacteria with sugar from their photosynthesis.

“By this, you get both vertical growing & grey-water purification. Therefore, the efficiency of the purification is dependent on the amount of solar radiation reaching the plants in the wall.” [web source cited above.]

Air Circulation Systems

“Active walls” are also integrated into a building's air circulation system. Fans blow air through the wall and then recirculate the refreshed air throughout a building. These indoor living walls help prevent and/or cure what is known as “sick building syndrome” by increasing air oxygen levels.

Integrating Water Features and Fish

Some Living Walls integrate fish ponds at the foot of the wall as part of the system where trickling water collects before it is pumped back up to the top of the wall.' The foliage purifies the graywater, digesting the dissolved nutrients. Thus a living wall can be an integral part of water purification and reuse, not just fresh air.



A living Wall is something to be designed to suit taste as well as to serve function. In a modular (analog or real) lunar outpost, each hallway could boast its own design, creating a more interesting working and living environment as well as a fresher, cleaner, healthier one.

You can go high-tech, but this is not necessary, and the cost-benefit ratios of a high-tech approach are probably not great. Low tech is always better if it works.

Using all Opportunities to increase biomass

We tend to make the mistake of describing living space volume in terms of square footage of floor space only, neglecting the opportunity walls provide. Counting all surfaces is the secret of packing a bigger biosphere into a smaller space: using walls, and even ceilings!

It is important, if we are going to bring the biosphere truly inside, to build our environment with mold-resistant surfaces. This means giving careful consideration to materials and surface coatings, as well as due humidity control and ventilation.

Sunshine, or its equivalent

Proper light must be brought in by light pipes, clerestories, or grow-lamps: a separate, related topic.

Purposes of a System of Living Walls in an Outpost

- Purify and freshen air; purify graywater
- Provide lush greenery, color, interest
- Provide herbs, spices, berries, etc. and last, but not least, to
- **Psychologically “reencradle” crews in a mini-biosphere**

<MMM>

M O D U L A R

B I O S P H E R I C S

Middoor Public Spaces as ideal opportunities for added vegetation and even “urban” wildlife

“Middoors” MMM speak for pressurized common spaces such as pedestrian passages, streets, parks, and plazas where temperatures could be allowed to fluctuate between cool predawn lows and warm pre-sunset highs; as opposed to “indoor spaces” in private residences and in commercial, educational, office and Other fully climate-controlled areas of activity.

In the December 2006 issue of MMM # 201, we described Living Wall systems which take advantage of frequently unused or underutilized wall-hugging spaces for growing plants that will help cleanse indoor air of carbon dioxide and other airborne pollutants, boost fresh oxygen levels, and in the process create water features that could harbor fish. In this installment of our “Modular Biospherics” series, we take up the opportunities for additional vegetation in other common spaces within the outpost or settlement.

Public Squares, Plazas, Marketplaces, etc.

These will be enlarged nodes or pressurized intersections where three or more pedestrian passages and/or pressurized roads restricted to bicycles and electric vehicles come together. At least some of these intersection nodes should be enlarged to provide extra ground space for plants of various kinds, walkways, park benches, water features, etc. They should offer two more perks: higher vaulted ceilings, and over-illumination.

Higher ceilings will offer welcome eye relief. The human eye has evolved to take in the sky, not just a horizon-hugging layer of vertical space. Living inside the confined vertically challenged spaces of an extensive modular maze will leave much to be desired. Yet, on the Moon at least, this may be necessary. The nitrogen needed as a neutral oxygen buffering component of breathable air will be in short supply. There are two ways to conserve the amount of nitrogen needed, and we will need to make use of both of them!

- Use one half normal air pressure, with all the hit being taken by nitrogen. That means, instead of a 79:21 nitrogen-oxygen mix, we may be using a 58:42 mix, with the actual partial pressure of oxygen unchanged. An important beneficial effect of using an 0.5 ATM pressure is that this will greatly reduce the propensity to spring leaks.
- Keep ceiling heights, and thus total volume of air needed, on the low side. I wouldn't suggest lower than 9 feet. That may seem generous, but we would be allowing for the progeny of the first settler generation to grow taller than their parents, given the low gravity.

But here and there it will be advisable, for the sake of morale, to have more spacious places in which to congregate and relax. Outdoor full sunlight level lighting and notably higher ceilings, painted a matte sky blue and brightly uplit, will subconsciously lift spirits and supply a well-needed boost. People will enjoy being there!

We have ample experience creating little urban oases for people to relax and congregate. A hard-won lesson is that as great as has been the clamor for quiet spaces apart from the hustle and bustle of life, the experience has been that such places remain almost empty, favored only by a few. In contrast, urban oases in the midst of the hustle and bustle are always the more popular. Put simply, more people enjoy relaxing where they can see and be seen. We are, after all, social animals.

Big or small, such openings in the otherwise space-stingy modular maze of settlement outposts, they can be much greener if the vertical surfaces around the perimeter nad vertical

half-wall dividers within it, are given to wall-hugging narrow trees or shrubs, or better to living walls as described in our last issue. As dividers, living wall systems can easily be configured in 2-sided fashion. Using the “hanging gardens of Babylon” approach, more floor/ground space is available to paving tiles, seating, water features, and sculptures.

If the space, say a plaza in a prospering, growing settlement, is large enough, it may contain building structures playing supporting roles: changing space for performing artists, storage space for merchant kiosks, etc. These structures may also provide more vertical space to be given to living walls, and their roofs can be green space as well, so that the building in effect does not diminish overall ground space given to plantings. Roof top tea gardens would be popular, creating elevated spaces from which to watch passersby, and other activity on the main level.

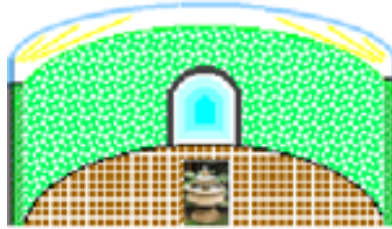

Illustration: a simple small “greenhub” node, an intersection of 3 or 4 pedestrian passageways.

It sports a higher vaulted ceiling, painted a matte sky blue, with cove uplit with bright sunshine spectrum bulbs. Vertical surfaces are living walls. The floor is of brick pavers or cobblestones, with benches, flowerpots, and a central fountain. The lower vertical scale of connecting pedestrian walkways is seen.

Enter the polinators

It is amazing how many people do not realize that plants come in male and female also. Be that as it may, we do need to provide for plant pollination. Bees might be confined to agricultural areas, with only persons not allergic to their sting working in those areas.

Hand pollination would be an unacceptable use of available manpower. Especially for agricultural areas, where similar plants are side-by-side, robotic hand-pollination equipment teleoperated from Earth where real labor costs are much lower, should be a priority area for research and development, with a lot of “spin-up” potential. In the meantime, we might concentrate on plant species that can be pollinated by hummingbirds. The sight of these tiny and beautiful creatures flitting to and fro in search of pollen syrup would do much towards making such urban relaxation spots all the more delightful. Might lunar hummingbirds slowly evolve larger subspecies? A hummingbird whose linear dimensions are 1.817 times Earth-normal for hummingbirds would weight as much on the Moon as our varieties do here.

We might make room for additional wildlife. Fish, talapia, small tropical, goldfish, even stream trout should mix well. But without adding in a mix of flying insects at great risk to serve as food, we’d have to feed them manually, or by automated fish-food dispensers.

Squirrels and chipmunks can do much damage, but they sure are delightful to watch. The same is true of rabbits and other small mammals. If only neutered individuals were released into the settlement commons, and breeding stock kept strictly sequestered, runaway populations could be avoided. Humans evolved side by side with plants and animals. Sure, some individuals would sooner be without them. But how truly “human” are they? We need to go into space as the front wave for Earth life at large. We just have to be careful what species we bring along with us. But that’s a whole new article.

If we are living, working, shopping, recreating, and traveling in pressurized spaces, there is no justification for any of these modules to be sterile, devoid of life. In our own cities, the boulevard is an icon for how pressurized roadways can be designed to contribute both to overall biosphere biomass, and to bio-diversity. Given the controlled climate, vehicles operating solely in pressurized environments can be open, roofless, and even open-sided. Of course, vehicles meant to operate at high speed would need wind-shielding.

Various Larger Pressurized Passageway Options

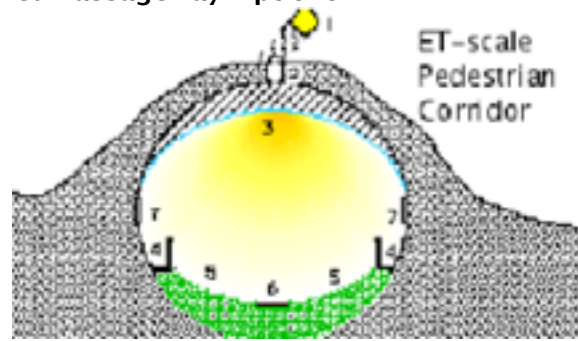

KEY: (1) Sun, (2) fiber optic bundle sunpipe, (3) sky-blue sunlight diffuser (same pressure either side), (4) pedestrian walkways, (5) terraced plant beds, (6) gardener's path, (7) art & poster gallery

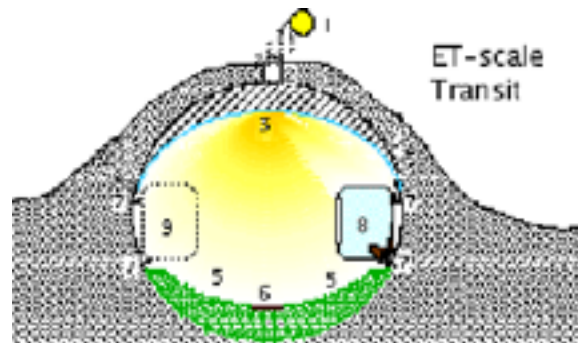

KEY: (1, 2, 3, 5, 6) as above. (7) wall-mount rail suspension system, (8, 9) bench seat transit car

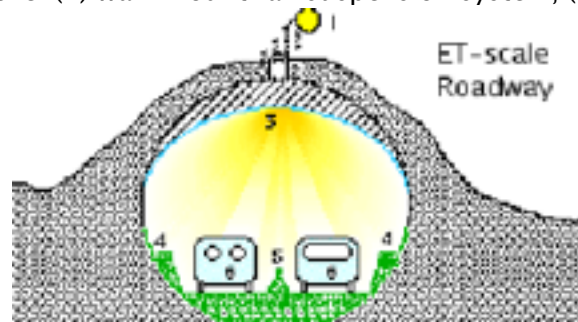

KEY: (1, 2, 3) as above. (4) living wall / hanging garden, (5) planter-topped divider, (6) vehicles

In all of these connector examples, there is a place for vegetation, and the more place the better. It is more than a matter of morale, the comfort of mothering greenery against the stark sterile barrenness beyond the settlement airlocks. It is a matter of always paying heed to the overriding requirement to maintain a healthy and integrally functioning biosphere as a host to all other activities within the settlement hull complex.

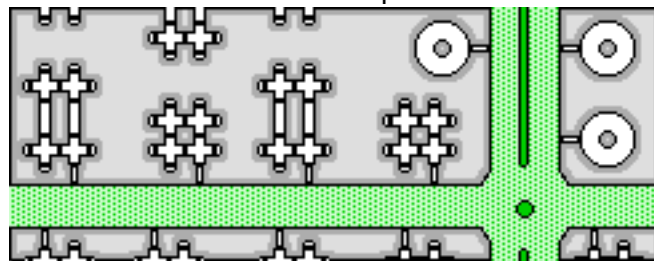

ABOVE: a sketch of how a residential settlement "block" grid could be laid out. The **Green** represents the pressurized road grid and its significant contribution to the

total biomass of this modular settlement biosphere. One road is shown in boulevard fashion, with an expanded roundabout intersection centering on a tree & shrubbery inner circle. The **Gray** represents the open-to-vacuum regolith covered surface. Shown in it, are various modular residences, individually regolith-shielded, all opening onto the pressurized road grid. This allows shirtsleeve travel throughout the settlement by pedestrians, bicycles, and electric vehicles.

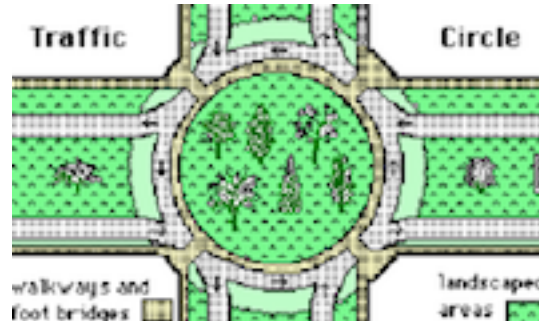

More on the Settlement's pressurized road grid

There is considerable discussion of many aspects bearing on the topic of public places in the lengthy article "**Luna City Streets**" MMM #109, October 1997, pp. 3-11. This article has been republished in MMM Classics #11, pp. 61-69 – a free access pdf file download from:

www.moonsociety.org/publications/mmm_classics/

MMM # 204 – APRIL 2007

M O D U L A R

B I O S P H E R I C S

By Peter Kokh

I. Living Wall Systems, Continued from MMM #201

We recently found this excellent example to share.

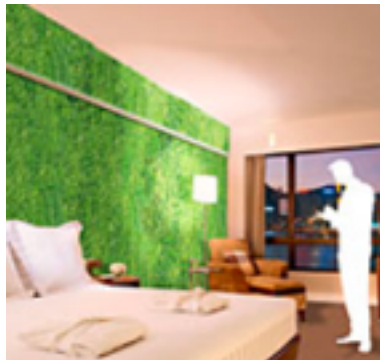

www.usatoday.com/travel/hotels/2005-05-05-hotel-of-tomorrow_x.htm

Toilet-equipped Habitat & Activity Modules Wolverton or alternate black water pretreatment systems

The organizing idea of "Modular Biospherics" is to distribute biosphere maintenance functions throughout a growing modular physical complex. This philosophy obliterates the "single point of failure" biosphere catastrophe scenarios to which any centralized system or complex of systems would be inherently vulnerable.

It is also a biosphere architecture that grows naturally as the physical complex of the outpost/settlement grows. The size of any “problems” that must be tackled in central, or neighborhood treatment facilities is greatly reduced. Modular Biospherics greatly reduces both the scope and the frequency of “growing pains” crises.

By distributing air and water treatment systems, biosphere maintenance becomes a democratic process: it is everyone’s concern, and the immediate local consequences of neglected systems affect most those who are guilty of the neglect. We take earth’s immense biosphere for granted (up until recently, anyway.) On the Moon, the health of the mini-biosphere of each settlement complex must be everyone’s business or catastrophic failure will only be a matter of time, and will come sooner rather than later.

Living Wall Systems are designed to refresh air throughout the complex, with only local maintenance needed. Stale air sets off personal mental alarm systems rather effectively.

But we must also treat waste water, both gray (sink, shower) and black (toilet wastes: urine and feces) locally. Not only does this give us a further opportunity to “grow fresh air” within every module that has a toilet system, but it helps pretreat blackwater at the source of the problem, greatly reducing the treatment burden to be handled in a centralized, or, better (in tune with our “as the settlement grows” philosophy), in neighborhood facilities. Wastewater treatment systems that “grow clean water” should be in every habitation and activity module: not just in residential quarters, but wherever people work, shop, go to school, play, or are entertained.

Many systems have been tried, some of them quite ingenious, mostly in rural settings that lack central water treatment systems. Some of these systems require an exhaust to the exterior atmosphere sink to handle the odor problem. As we can’t exhaust stinky air outside on the Moon, at least not routinely, many “composting” toilet systems that work perfectly well on Earth will not pass muster on the Moon. The odor problem must be handled on the inside! That creates an extra burden, which to anyone with the proper attitude, translates to an inviting “challenge,” the kind of incentive that spurs ingenuity to greater achievement.

The Wolverton gray water system is one option that has worked for nearly 30 years in the home of retired NASA environmental engineer, Bill Wolverton in Houston.



KEY: 1 side- or wall-flush toilet; 2 blackwater tank with microbes to break down solids & destroy pathogens; 3 inert filter with irrigated soil; 4 plants rooted in wet soil mixture; 5 effluent water is 95% pretreated, ready to water plants in the greenhouse and elsewhere. – illustration by the author.

There are undoubtedly other systems, but Dr. Wolverton’s well-tested system sets the bar against which other systems must be measured.

The system above handles the load imposed by two people. We need to know how many people-hours per day that translates. Are they home all day, everyday? Or half the day most days? Blackwater systems must be rated in people-hours capacity if we are to size them to the daily loads of other activity modules such as work spaces, offices, schools, shopping areas, etc.

If we can someday deploy a modular lunar analog research station facility, we will want to try a variety of such systems in order to verify how well they work, and how they compare on various performance parameters. This fits the goal of such an analog facility to demonstrate the technologies needed for actively growing lunar outposts and settlements. There may well be a

commercial component of such experimentation, with various manufacturers contributing systems for the various modules in a high-stakes game of make or break.

The penalty of not aggressively developing a full suite of modular biospheric technologies is clear. The planned “visitable” (but no longer intended to be permanently manned) outpost must be constantly resupplied from Earth, or by a very wasteful program of local throwaway oxygen and water production. Engineers and architects of modules may prefer to “keep it clean, and sterile” but our job is to create a “biosphere flywheel” that largely maintains itself with a modest amount of monitoring. We need to keep dependence on resupply from Earth to a minimum, if we are going to progress to the point where those on the Moon can survive politically or economically driven cutoffs of support, be they temporary or indefinite. This must be our goal! <MMM>

Lunar Zen Gardens Inside & Outside The Blending of Interior and Exterior Spaces

By Peter Kokh

In last month’s Mars-theme issue, we discussed how Martian pioneers could blend indoor and outdoor spaces. These pioneers will be working with a different color palette, and eventually, with something more than sand and rock: plants, once Mars-hardy plants begin to take root out in the open under a steadily thickening and warming atmosphere.

On the Moon, we have just regolith (sand analog) and rock to work with. Fortunately, these two elements have been media enough for artists in many cultures from the Stone Age through the present. Stonehenge comes to mind, but that, and many similar pre-Celtic creations are evidently something more than artful arrangements.

When it comes to sand, be it desert or beach sand, people (and children) have been drawing patterns and pictures in them with a stick from time immemorial. <http://hebert.kitp.ucsb.edu/sand/tradition.html> But the most refined art form combining sand and rock is arguably the classic, serene Zen Garden, in which an odd number of different shaped stones or rocks are placed in a “sea” of sand, complete different shaped stones or rocks are placed in a “sea” of sand, complete raked “ripples.” This is an art form that begs to be translated with lunar elements found everywhere: moondust and boulders. We can do this out on the surface, but also indoors: below is a design perfect for a lunar home foyer.

Zen Gardens in Lunar Homes



If there is a Zen garden just inside the airlock, there could be another just outside, especially if it is visible, along with persons coming and going, through a periscopic picture window. The garden outside, though constructed of thoroughly natural elements, puts a friendly, welcoming human touch on what otherwise may seem an alien and hostile landscape.

Inside, the Zen Garden will look the same only with very careful preparation. The moondust must first be purged of the troublesome fine powder component, the last thing we want to bring inside our living spaces. Then, using a magnet, one must purge as much of the

iron fine component as possible. Why? Because the moondust has never been exposed to humidity before, and will begin to take on a rusty color instead of its characteristic gray tones. The effect would look somewhat Martian. An option would be to use controlled gradual purging of the regolith so that nearest the outside (nearest the airlock) gray tones would predominate, gradually shifting towards rusty shades at the end furthest from the airlock. This could symbolize an assimilation of the lunar environment.

Of course, there is no reason to limit placement of small indoor Zen gardens to the airlock antechamber. They might be even more appreciated in the foyer of a lunar homestead at the entrance to the home from a pressurized settlement street or passageway. Far more visitors will enter lunar homes from other pressurized areas than directly from the out-vac, the airless surface. As such it will be a statement that this is the home of Lunans, people at home on the Moon, welcoming others who have also made that passage.

Small **tabletop** Zen Gardens can be put in dens, bedrooms, anywhere people will enjoy having them.



A strange but fitting companion for a small Zen Garden might be a **Bonsai tree** planter, representing the forests left behind on Earth.

Zen Gardens out on the Lunar Surface

There is no reason to restrict Zen Gardens to the airlock entrance areas. On the other hand, as they take some labor in a space suit to create and arrange properly even if all the elements are handy to the location, we are unlikely to see the median strips in lunar versions of our divided highways in the form of a continuous Zen Garden!

We might see them as periodic trail markers, at road junctions, scenic waysides and rest stops. Wherever we create them, they will remind all who pass and enjoy them that we are Lunans, people who have come to live with the Moon in harmony. Zen Gardens, whether indoors or out on the surface, will be a respectful way of saying that we will make the Moon a human world, even as it reshapes us as Lunans into its own people. <MMM>

MMM # 206 – JUNE 2007

M O D U L A R

B I O S P H E R I C S

VI. Food Production with Diversity: vegetables, dwarf fruit trees, herbs & spices

By Peter Kokh

Most of the “Experimental Lunar Agriculture” projects I am aware of, were attempts to show that we could grow various staples, notably wheat and potatoes, under lunar greenhouse conditions. While it is essential that personnel on the Moon receive adequate nourishment, the “human system” requires more than just nourishment. If humans are going to be productive in frontier situations, they must be reasonably content.

Now a lot of factors come in here, but one thing is not debatable. Tasty and varied menus are indispensable to keep personnel productively content.

From that point of view, we need a variety of vegetables and carbohydrate sources. Those that can be prepared in a number of different ways rise to the top in priority, potatoes, for example, but also several others.

Nor do most people long tolerate bland food. Vegetables and Salad Stuffs are not enough. Most of us would dearly miss occasional or regular fruits. Now the problem with fruit is that most fruit plants take longer to mature than vegetable plants do, significantly longer. Short bushy fruits like blueberries and strawberries might be the place to start. Apples, for example, would not be available very soon. Cultivating dwarf fruit trees makes sense, not only for quicker maturation, but to fit limited cubic greenhouse space.

Herbs & Spices must not be neglected. These additions can be added by each person to prepared and pretested food items, to suite their taste. Some cannot tolerate spicy foods at all. Myself, I can consume XXXX buffalo hot wings with no problem.

Cultivating plants with medicinal and pharmaceutical value would be a smart choice, if only to cut down on the import of over-the-counter remedies.

Beyond the Greenhouse

The communal greenhouses will of necessity concentrate on the key staples and principal vegetables. But, if our outpost morphs into a settlement by modular additions, and if we follow the principles of “Modular Biospherics,” we will have many opportunities to grow supplemental crop varieties.

If each module has a Wolverton type toilet waste graywater system, some of the plants involved could be herb, spice, and pharmacopeia varieties. Living walls in connector passageways give ample opportunity for growing supplemental crop varieties. But it is important to realize that these passageways are “commons” areas. The personnel (and pioneers) will have to respect an honor system not to help themselves. And, there must be a person or group of persons who adopts each living wall and cultivates its plants.

If private quarters contain some well-lit spaces in which small private gardens can be maintained, this will provide a special opportunity for cottage industry enterprises that specialize in adding special treats to the diet.

Weekend or sunthly (following the cadence of the lunar month: dayspan, nightspan, dayspan, etc.) markets could feature both cottage industry stalls and consignment areas, where produce (and produce products such as preserves, salsa, prepared condiments, cut flowers, floral arrangements, ornamental houseplants, and organic dyestuffs) can be marketed. In this way, free time hobbies will provide a variety that could not otherwise be made available, while jump-starting an indigenous pioneer economy of goods and services.

Integrating Architecture and Life

We cannot stress enough that these developments will require a commitment to “Modular” Bio-spherics,” by which the biosphere and biosphere mass will grow automatically with the addition of each new module. Yes, if we proceed with sheer physical expansion, and add neighborhood air and water and waste biomass treatment facilities as needed, we will eventually reach a population size threshold, a much bigger population and higher threshold, at which food varieties will begin to appear.

But if we adopt the Modular Biospherics plan from the gitgo, in the architecture of the first core outpost, we will be able to benefit from food and menu and byproduct variety much sooner, from the very start. The earlier constructive traditions are adopted the better.

Modular Biospherics in a Lunar Analog Station

Modular Biospherics is something that can't wait. That is why we have worked this special architecture into the preliminary planning of our own (Moon Society – NSS) Lunar Analog Research Station proposal.

Click on “Proposal Slide Shows” at the top of: www.moonsociety.org/moonbasesim/proposals/index.html

If we do not start off on the right foot from day one, the delay could easily grow to a decade or more. Of course, adopting “modular biospherics” implies a commitment to continuous occupancy. That is Mwhat we all thought was implied in President Bush’s call for NASA to “Return to the Moon to Stay.” Unfortunately, Mike Griffin is committed only to producing and landing a core lunar outpost that would be enduring, but not continuously occupied. But then he has also scrapped all NASA advance life support projects. Advanced = biologically assisted. Shut down are both the BioPlex in Houston and Purdue’s NSCORT research program. We are clearly off on the wrong foot. This may be a gamble by Griffin to force Congress to raise NASA’s annual budgets, but it is a game of “chicken” that can only lead to a program crash.

Private and Private Enterprise efforts to deploy lunar outposts are the only real hope that things will be done as they should be, and that we will locate them in an area where all the needed resources are available, not just water and sunlight, a place out of which we can rationally expand. But I digress to grind my favorite ax.

Modeling “Modular Biospherics” is the only way to test out the vision outlined above. In any open-ended modular lunar analog research station, where each module contributes something to life support, many options can be tested to see which work best, better, and good enough: graywater system options; living wall system options; supplemental food and other plant growth options.

Without a Modular Biosphere type analog station, our dreams are unlikely to come true.
<MMM>

We humans have been “Systemfaring” the “Continental System”

For a Hundred Thousand Years;

The Solar System at large is next,

Then Star Systems without end.

– Simon Cook

MMM # 214 – APRIL 2008

“Mother Earth & Father Sky”

The “Planet Earth & Space” Conference Proposal

From Peter Kokh, Moon Society President; Member, NSS Board of Advisors

An Opportunity

Last December, Moon Society Board member, Dr. Schubert first identified an opportunity for us to apply for EPA funds for a “broad-based” conference on “Climate Change” remediation measures, and, with enthusiastic NSS support and engagement, and input from a handful of others, we put together a specific proposal dubbed the “Planet Earth and Space Conference.”

Rising to the Occasion

From the outset, we saw this as a perfect opportunity to start a constructive and productive “conversation” with the environmentalist community. Two of us on the committee, Lorreta Whitesides, wife of NSS Executive Director George Whitesides, and myself are dedicated members of both communities and have insight into why, both groups, equally dedicated to preserving our home world, continue to talk past one another. We come from different cultures. Lorreta and I separately listed areas in which we thought conversation might be especially fruitful, and with that input, Peter Schubert drafted the specific proposal which was endorsed by everyone on this ad hoc committee.

We then approached a “bridge group,” the Earth and Space Foundation whose leaders are personal friends of the Whitesides. They enthusiastically cosponsored the proposal. We

managed to get the sponsorship of an environmental group also just in time for the January 8, 2008 first (of 3) submission deadlines.

Disappointment

Having only 2 slots and many proposals, EPA did not accept ours. This conference, if it had been approved, and if it were successful, would have brought together two constituencies that while driven by different cultures, are both focused on preserving Earth for future generations.

Keeping the Proposal Alive for Another Opportunity

The conference will address individual and local here & now approaches as well as long term space-based measures. We would show how development of some technologies needed in space will help here on Earth. If this conference goes forward, and is successful to the point where we want to do this every other year, that will be a big feather in our cap, promotion wise.

This conference may include workshops focused on potential benefits here and now of predevelopment of some of the technologies listed in the "Game Plan" above, as well as of biological life support issues and biosphere sustainability technologies. If we can get even some elements of both very stubborn constituencies to start talking to one another, that will be an achievement. <PK>

MMM # 215 - MAY 2008

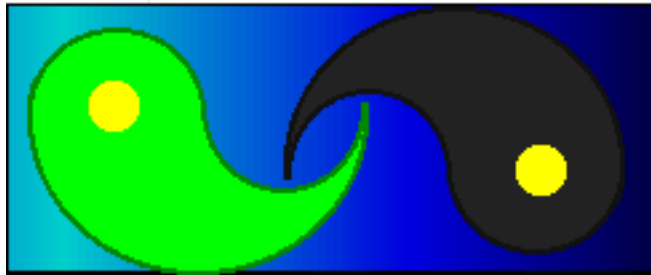

IN FOCUS Earth Day 2008: Taking the Green Spirit to the Moon

We all know that at best, public interest in space is shallow: "a mile wide, and an inch deep." Among young people and among the growing percentage of those who are, or are becoming, "environ-mentally conscious," one of the most frequent reservations we hear is this simple challenge: "Why should we go to the Moon (or Mars) and trash them the way we are trashing the Earth?"

It is not to our credit that too often the response is to dismiss the question as well as the questioner. If we are going to build support, as we must, so long as we are stuck with a tax-supported program, we need to take this on this challenge with due respect. To fail to do so, only confirms the plaintiff's suspicions. Not exactly to our credit, too many space enthusiasts consider environmentalists the enemy, instead of natural allies whom we must do our best to court. It is possible!

If we love our own vision, we owe it to our own dreams to get past this silly pettiness. Nor should we pout and wait for "them" to make the first move towards reconciliation, cooperation, and collaboration. Unless we take the lead, we can forget about building significant public support. We already share one most significant goal in common: preservation of Mother Earth for future generations. We come at it from different perspectives, and from different cultures. This gap can be bridged!

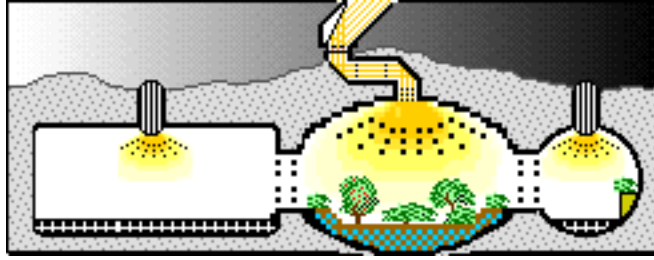

What follows is a brief outline that our conversation with the Greens, and with ourselves (a guideline to considerations we must address in our own plans to advance the day when civilians will be living on the Moon, engaged in pursuits which will assist those on Earth to survive our current crises, crises probably typical of “adolescent” intelligent civilizations. Later in this issue, we will address these points in paragraph form, leaving fuller treatment to individual future articles.

Read: <http://www.moonsociety.org/projects/projectteams/enviro-space/PKGreenSpaceConf.pdf>

Points to Make with the Environmentally Concerned

(A) Mining concerns:

Mining methods: most of the major and minor elements we will need are found in sufficient abundance in the rock powder blanket that covers the Moon’s surface. The need to strip mine or mine deep underground is very minor.

Tailings: By conducting a cascade of mining sequences where removal of one needed element makes the tailings that much richer in other elements, we constrain our regolith mining operations and greatly reduce the total of energy input needed, and then using the final tailings residue for secondary construction uses.

(B) Recycling concerns:

Recycling spent energy; Everything we make embodies the energies needed to produce it. We can recycle that energy by recycling the materials, as items are replaced.

Industrial design: We can choose assembly methods so that diverse materials do not contaminate one another and can be easily separated for proper recycling.

Economics: to become economically viable, we need to make maximum use of everything we produce, and that can be done best by a comprehensive recycling system. This maximizes use, minimizes throughput (resources in/discarded waste out), minimizing our lunar “footprint.”

Enterprise: A very high percentage of entrepreneurial opportunities for pioneers will be in the area of reusing materials no longer serving their original design purpose.



(C) Concerns raised by our bad record on Earth:

Postponed urgency: Our biosphere (atmosphere, hydrosphere, flora and fauna) is so vast until recently it has been doing a good job of handling of recovering from our environmental sins. We postpone solutions to the next generations (for which we will be condemned.) On the Moon, we must live in self-contained mini-bio-spheres, essentially living downwind and downstream of ourselves. What we do wrong will hurt us immediately. We learn to live in

harmony with our mini-environments, or we will quickly get the “game over” message. The lessons we learn can be exported to Earth. – PK

Making the most of pressurized pedestrian & vehicular corridors: "Living Wall Systems"

By Peter Kokh

The common stock answer given by space enthusiasts to those who protest plans to go to the Moon by saying that “we will only trash the Moon as we have been doing Earth from time immemorial” is “the Moon has no biosphere, atmosphere, or hydrosphere to pollute.” This reply is anything but convincing. “Trashing” includes garbage piles, physical scarring, and other ways we disrespect our own environment. Again, we do what we do, postponing lifetime costs, because it is cheaper, and above all, because our terrestrial environment is so vast that we believe we can continue to get away with it.

Primates cannot be housebroken. And up till now, all the evidence has been that humans cannot be planet-broken. We foul our own home world.

The message we need to get across to the environmentally concerned is this:

“On the Moon, we must live in mini-biospheres of our own creation and maintenance and will be essentially living downwind and downstream of our selves. There will be no “somebody else’s backyard.” We will have to learn how to live in harmony with and within our pockets of Nature, or, in gamers’ language, it will be quickly “game over!”

We could learn those same lessons here on Earth, but we won’t, because the need does not seem pressing. But lessons learned and technologies developed on the Moon because pioneers will have no choice, can all be exported to Earth. In short, one very vital reason to go to the Moon, a reason seldom considered, is that we need to do so to learn how to save Mother Earth, not from energy shortages (that too) but “from ourselves.”

Yes, the Greens (I am one, and I am sure that some of you are also) are trying, and have come up with many ways for us to do better. Yet much of such insight is lost on those who do not see the urgency, or do not want to be inconvenienced, or do not want to see their incomes go down even temporarily. Environmental action on Earth helps postpone the day of final reckoning. But it cannot stop pillage of our planet simply because runaway population growth more than neutralizes these efforts.

Itemizing concerns and measures to meet them

Many people do not want to see the surface of the Moon, as visible from Earth, scarred. We need to stress reasons why a growing human presence on the Moon need not do so. Most mining will be within the already pulverized rock powder blanket 2–10 meters thick that covers the Moon. We extract what we need and leave the remnant in place. We will obliterate small craterlet dimples, but steer around bigger ones still too small to be seen from Earth even with most telescopes.

As to roads and railroads, they will themselves be too small to be seen by the naked eye. As to settlements, the need to cover them with regolith shielding, both to protect from the inclemencies of cosmic weather and to sustain a thermally moderate environment, will, so to speak, camouflage them with moondust. As to lunar city lights, light aimed upward will be wasted energy. Lunar cities, except for lit spaceports, will be nothing so dramatic as the brilliant urban cluster lights of Earth. Gradual oxidation of iron fines in the regolith will slowly redden the moondust, but perhaps in a way too subtle to be noticed by the naked eye (as opposed to scientific instruments.)

As we pointed out in the editorial above (page 2b) lunar settlers will be behind the economic “eight-ball” for some time. Using energy and materials as efficiently as possible will be a must if they are ever to reach economic viability and sustainability. This need will force

recycling of used energy and used materials at a level far beyond the token and somewhat trivial measures we are slowly trying to adopt here at home.

We also need to identify what we waste so readily here on Earth: paper, wood, plastics: their constituents, carbon, oxygen, hydrogen, and lesser amounts of other volatiles are superabundant here on Earth: in a word, “dirt cheap.” Those same elements, excepting oxygen, are many orders of magnitude less abundant on the Moon and thus as precious on the Moon as are gold, silver, and platinum here on Earth. The very things we discard without a thought or care here below, will be religiously recycled back into our life-sustaining mini-biospheres. It will not be an exaggeration to say that this turnabout will be a matter of “life or death.”

Modern industry has learned a very neat but also nasty trick: using super-adhesives to assemble unlike materials that effectively cross-contaminate each other in a way that makes recycling impossible or many times more expensive than it needs to be. At the same time, the growing mobility of our population has created a niche for “knock-down” furniture that can easily be taken apart and reassembled at a new location. This method of assembly minimizes cross contamination and maximizes the possibility of proper recycling. It should be the law. The point is that options exist that will help Lunan pioneers avoid the pitfalls into which we have leapt.

Even on the Moon, with sunshine abundant enough to cover energy needs, nightspan as well as day-span, it will make no sense to waste energy. For one thing, wasted energy exacerbates the need to radiate excess heat produced. Wasted energy also increases the mass of energy production equipment needed. Learning to reuse spent energy, by recycling everything possible, over and over again to reduce overall throughput, can but help the pioneers reach and maintain economic viability.

A lesson that many a detractor of environmental approaches has failed to learn or admit, is that doing things the right way generates more income opportunities than it removes from the approved list. All communities that have been “going green” have experienced economic growth, as counterintuitive as that may seem.

Many space enthusiasts envision communities beyond Earth as inanimate constructs, clean and metallic, “uncontaminated” by vegetation or critters, even of the microbial kind. A few house plants will be “tolerated.” I suppose we can eat Soylent Green or nutrition capsules produced by nanotechnology. Fortunately, these are the fringe in our pro-space constituency. Lunans will be surrounded by more vegetation than most urban terrestrials. We have to stop thinking, and speaking, of humans going to the Moon and Mars. We need to start thinking, and speaking, of Earth Life, stewarded by humans, bringing Mother Earth to Father Sky for the ultimate consummation. In that light, we will not be invaders, but suitors that can alone realize the previously thwarted ability of alien and sterile worlds to become life-sustaining worlds. In that light, we hardly trash them. We go to make other worlds “whole!” – PK

Why Lunan Pioneers will turn their Gray World into a “Green” Sanctuary

By Peter Kokh

The common stock answer given by space enthusiasts to those who protest plans to go to the Moon by saying that “we will only trash the Moon as we have been doing Earth from time immemorial” is “the Moon has no biosphere, atmosphere, or hydrosphere to pollute.” This reply is anything but convincing. “Trashing” includes garbage piles, physical scarring, and other ways we disrespect our own environment. Again, we do what we do, postponing lifetime costs, because it is cheaper, and above all, because our terrestrial environment is so vast that we believe we can continue to get away with it.

Primates cannot be housebroken. And up till now, all the evidence has been that humans cannot be planet-broken. We foul our own home world.

The message we need to get across to the environmentally concerned is this:

“On the Moon, we must live in mini-biospheres of our own creation and maintenance and will be essentially living downwind and downstream of our selves. There will be no “somebody else’s backyard.” We will have to learn how to live in harmony with and within our pockets of Nature, or, in gamers’ language, it will be quickly “game over!”

We could learn those same lessons here on Earth, but we won’t, because the need does not seem pressing. But lessons learned and technologies developed on the Moon because pioneers will have no choice, can all be exported to Earth. In short, one very vital reason to go to the Moon, a reason seldom considered, is that we need to do so to learn how to save Mother Earth, not from energy shortages (that too) but “from ourselves.”

Yes, the Greens (I am one, and I am sure that some of you are also) are trying, and have come up with many ways for us to do better. Yet much of such insight is lost on those who do not see the urgency, or do not want to be inconvenienced, or do not want to see their incomes go down even temporarily. Environmental action on Earth helps postpone the day of final reckoning. But it cannot stop pillage of our planet simply because runaway population growth more than neutralizes these efforts.

Itemizing concerns and measures to meet them

Many people do not want to see the surface of the Moon, as visible from Earth, scarred. We need to stress reasons why a growing human presence on the Moon need not do so. Most mining will be within the already pulverized rock powder blanket 2–10 meters thick that covers the Moon. We extract what we need and leave the remnant in place. We will obliterate small craterlet dimples, but steer around bigger ones still too small to be seen from Earth even with most telescopes.

As to roads and railroads, they will themselves be too small to be seen by the naked eye. As to settlements, the need to cover them with regolith shielding, both to protect from the inclemencies of cosmic weather and to sustain a thermally moderate environment, will, so to speak, camouflage them with moondust. As to lunar city lights, light aimed upward will be wasted energy. Lunar cities, except for lit spaceports, will be nothing so dramatic as the brilliant urban cluster lights of Earth. Gradual oxidation of iron fines in the regolith will slowly redden the moondust, but perhaps in a way too subtle to be noticed by the naked eye (as opposed to scientific instruments.)

As we pointed out in the editorial above (page 2b) lunar settlers will be behind the economic “eight-ball” for some time. Using energy and materials as efficiently as possible will be a must if they are ever to reach economic viability and sustainability. This need will force recycling of used energy and used materials at a level far beyond the token and and somewhat trivial measures we are slowly trying to adopt here at home.

We also need to identify what we waste so readily here on Earth: paper, wood, plastics: their constituents, carbon, oxygen, hydrogen, and lesser amounts of other volatiles are superabundant here on Earth: in a word, “dirt cheap.” Those same elements, excepting oxygen, are many orders of magnitude less abundant on the Moon and thus as precious on the Moon as are gold, silver, and platinum here on Earth. The very things we discard without a thought or care here below, will be religiously recycled back into our life-sustaining mini-biospheres. It will not be an exaggeration to say that this turnabout will be a matter of “life or death.”

Modern industry has learned a very neat but also nasty trick: using super-adhesives to assemble unlike materials that effectively cross-contaminate each other in a way that makes recycling impossible or many times more expensive than it needs to be. At the same time, the growing mobility of our population has created a niche for “knockdown” “KD” furniture that can easily be taken apart and reassembled at a new location. This method of assembly minimizes cross contamination and maximizes the possibility of proper recycling. It should be the law. The point is that options exist that will help Lunan pioneers avoid the pitfalls into which we have leapt.

Even on the Moon, with sunshine abundant enough to cover energy needs, nightspan as well as day-span, it will make no sense to waste energy. For one thing, wasted energy exacerbates the need to radiate excess heat produced. Wasted energy also increases the mass

of energy production equipment needed. Learning to reuse spent energy, by recycling everything possible, over and over again to reduce overall throughput, can but help the pioneers reach and maintain economic viability.

A lesson that many a detractor of environmental approaches has failed to learn or admit, is that doing things the right way generates more income opportunities than it removes from the approved list. All communities that have been “going green” have experienced economic growth, as counterintuitive as that may seem.

Many space enthusiasts envision communities beyond Earth as inanimate constructs, clean and metallic, “uncontaminated” by vegetation or critters, even of the microbial kind. A few house plants will be “tolerated.” I suppose we can eat SoyLent Green or nutrition capsules produced by nanotechnology. Fortunately, these are the fringe in our pro-space constituency. Lunans will be surrounded by more vegetation than most urban terrestrials. We have to stop thinking, and speaking, of humans going to the Moon and Mars. We need to start thinking, and speaking, of Earth Life, stewarded by humans, bringing Mother Earth to Father Sky for the ultimate consummation. In that light, we will not be invaders, but suitors that can alone realize the previously thwarted ability of alien and sterile worlds to become life-sustaining worlds. In that light, we hardly trash them. We go to make other worlds “whole!” – PK

MMM # 219 – OCTOBER 2008

IN FOCUS Using the Green Movement to Advance Technologies Needed on the Lunar Frontier

In our article “Books on the Moon” pages 5–6 this issue, we write about Amazon.com’s new electronic book reader, the Kindle, as a prototype for what we’ll need to read books in a situation where paper will be as priceless as platinum. Amazon’s Kindle will appeal to Green enthusiasts (we are one of them) but, of course, Amazon.com went forward with this project for profit motives. But that is immaterial. What counts is that Kindle will also appeal to those who would like to find ways to slow down deforestation. Forests help keep the atmospheric cycle healthy, serving as sinks for carbon dioxide. That is especially important as we continue to produce ever more CO₂ as consumption of fossil fuels continues to increase as the “Third World” continues to accelerate its already rapid “catch-up” pace.

Inorganic Substitute for Wood Furniture

On the Moon, you can forget about wood “case goods,” furniture industry jargon for wood furniture such as dressers, tables, etc., including bedroom sets, dining room sets, etc. So if we can leverage the Green Movement to slow deforestation by switching from wood case goods to a substitute (definitely not plastics derived from fossil fuels) that will not only help slow deforestation but will develop prototypes of something we will need a lot of on the Lunar Frontier. One possibility here is to predevelop glass-glass composites as a substitute furniture material. Just as there is plenty of sand and rock dust on Earth, we have an inexhaustible supply of rock powder and dust on the Moon – called “regolith” or more simply “Moondust.”

We’ve been pushing this for twenty years, and now we have at last a strong incentive to predevelop this technology for making profits here on Earth, hitchhiking on the growing Green Movement. See: http://www.lunar-reclamation.org/papers/glass_composites_paper.htm In our article in MMM#4 April 1987, “Paper Chase II”

www.asi.org/adb/06/09/03/02/004/paperchase2.html

we discuss possible substitutes for a variety of wood and paper uses: labels on cans and bottles, posters, letters and greeting cards, wrappings and packaging, and much more. For the Moon, the economic incentive is of “make or break” priority. While at the present, wood and paper substitutes are not always really cost competitive, the motivation of those seeking Green Solutions, especially solutions that slow deforestation, is strong enough to provide a test

market for new products that could serve as prototypes for wood, paper, and plastic substitutes we will absolutely need on the Lunar Frontier.

While we don't expect most environmentalists to care a bit about the needs of future lunar pioneers, those space enthusiasts who do care, can now look for economic support from the Green Movement to help introduce such new products even at a some competitive disadvantage. In other words, the enterprising among us Lunies ("Lunans") can attempt to predevelop such products in an atmosphere where cost-comparison is not a factor for a growing percentage of those willing to pay a bit more to reduce their "carbon footprint." Ordinarily, new products are at some cost-pressure disadvantage by having to amortize quickly the development costs involved in bringing them to market.

What we are saying, is that right now we have an increasingly more friendly environment in which to pre-develop some of the many technologies that will be needed to make a Lunar Frontier work economically in a situation where wood-paper-plastics, ultra-cheap on Earth because of our enormous biosphere, will be ultra-expensive on the Moon where there is no existing biosphere to tap, and where the elements needed to develop a biosphere (hydrogen, carbon, nitrogen) are quite rare.

If you are a Moon guy, and an entrepreneur who wants to help, but needs to make money now, this is your big chance. Read the articles cited! <PK>

MMM #230 NOVEMBER 2009

**Antarctica's McMurdo Station:
Preview of Growth & Expansion of a First Lunar Industrial Settlement?**

By Peter Kokh khmmm@aol.com



The maze of McMurdo Sound Station from above: A harbor, 3 airfields, a heliport and over 100 buildings

With a summertime population of 1,300, this outpost is a functioning city. The only difference with conventional cities is that its population consists of only temporary residents: no families making the continent their home. But that is another story. The Antarctic Treaty discourages settlement, private property, and development of local resources to support a viable economy. Those provisions are a powerful reason not to look to the Antarctic Treaty as a model to apply to the Moon.

McMurdo is about 55 years old and its growth to its present state has been steady, driven by the ongoing expansion of the research programs supported there. Is there a pattern to that growth that suggests how an outpost on the Moon could morph into a settlement over time? From one angle the answer is a resounding “no!” We would expect a lunar outpost’s growth to be accelerated by a steady shift in reliance on imports to basing growth on locally produced materials and goods. That would be reflected in the appearance of added structures and their furnishings trending toward a definite made on luna look and feel. A lunar outpost would sink roots as it grows. McMurdo’s growth is supported by an insatiable appetite for ever more imported supplies. This pride of Antarctica would die a cold death in a minute were the supply chain cut. In the battle to keep supplies flowing, icebreakers and cold hardy cargo planes are the workhorses.

Nor does McMurdo produce any goods or exports other than knowledge and reports of real interest but of no economic value. As big as the outpost has grown, it has made no progress towards self-reliance or economic viability. Again, not a model to be inspired by.

Science is the reason McMurdo exists but the scientists are outnumbered by providers of support for operations, logistics, information technology, construction, and maintenance.

After a visiting Greenpeace ship documented haphazard littering and apparent lack of appreciation for the host environment, the outpost was forced to cleanup and rethink the way it expands and the way it deals with discarded and used items. This catharsis has been all for the good. Waste not, want not. But this is a lesson a lot of are learning in cities and towns wherever we live.

We have pointed out that for a lunar outpost, a prior plan for warehousing incoming supplies as well as replaced items, together with a plan for site management and planned vectors of growth are essential if the outpost complex is to grow in an orderly and efficient manner. Historically, most towns and cities have grown by one “afterthought” after another. Planned growth need not mean cookie cutter replications. Variety, inventiveness and individuality are what make towns attractive.

McMurdo is Antarctica’s principle hub, both for supplies coming by sea and for those arriving by air. A sector of the population is occupied entirely by these logistic activities. But it is also a departure point for many overland exploratory excursions. If McMurdo did not exist, we’d have to invent something quite similar.

There is no manufacturing district, no farmers market, no schools for children. A city it may be, but a parody of what we mean by city nonetheless.

If a lunar outpost is to focus on weaning itself of total dependence on imports from Earth, it must grow industries and enterprises and farms and trade partners. In this sense, the smallest African village is perhaps a better model of growth to follow than is McMurdo.

Most of the growing tourist trade to the continent skirts its perimeter, exploring off-shore islands along the Antarctic Peninsula below the tip of South America. McMurdo is half an Earth-turn away, below the tip of New Zealand. Tourists are not encouraged. If you want to go, join the Navy, become a scientist, or find employment with one of the station service suppliers.



Albert P. Crary Science and Engineering Center, 1991

Many space enthusiasts look for the day when we have something similar on the Moon. Yes, humans would be there in force. But no, this would not be a genuine human settlement paying its own way with a mix of industry, agriculture, and trade, growing its own work force family-style rather than by temporary assignment.

McMurdo’s growth drivers and growth vectors are not the natural ones of real cities. It will never be “home” to anyone, just a place to pretend is home. Despite its location on a previously uninhabited continent-world, it is not a model for lunar settlement developing local resources to become economically independent. PK

The Successful Opening of the Lunar Frontier Will Require More Than One Settlement

By Peter Kokh

An overwhelming percentage of lunar advocates, both professional and enthusiast supporters, assume that “the” lunar outpost will be at one of the Moon’s poles, with the South Pole the current favorite. We have many times stated our objections to this location on these grounds:

- The **available sunlight** is not full time, and so we must learn to store power for use when sunlight is not available. So why not learn to do this for as long as two weeks, which would enable us to go anywhere
- **Water is essential** and would be costly to support and at the poles water ice is available. In fact what is there is at cryogenic temperatures and not a resource that we can expect to tap near term
- The **temperatures at the pole** (excepting permanently shadowed crater bottoms) are moderate. But we have already endured “midmorning” temperatures on the Moon during the Apollo days. Being “afraid” (let’s call a spade a spade) of nightspan cold and dayspan heat is not a trait that bodes well for us as pioneers. We must learn to live in conditions that apply globally on the Moon, or just forget about it.

But from the vantage point of the Moon Society’s declared vision statement, “formed to further the creation of communities on the Moon involving large-scale Industrialization and private enterprise”

the choice of “a” site is by itself “out of order.” Why? Because the list of resources that will be needed for such an ambitious goal, are not to be found in any one location on the Moon: not at the poles, not at any other single location.

We owe it to our own stated commitment to start at a place from which we can easily expand. The South Pole is more highland-locked than is the North Pole, where twice as much water ice seems to be available. But we will want to tap resources that are more abundant in the maria as well as those more plentiful in the rugged highlands. But not all maria areas are equally endowed.

Some maria and mare-fringe areas are rich in KREEP deposits, that is, in Potassium (K), various rare earth elements (REE) and Phosphorus (P). Other areas are rich in ilmenite, an iron-titanium-oxygen mineral. Others are richer in uranium and thorium, which could support a lunar nuclear fuels industry. Then there are special places like the Marius Hills, which may contain volcanic volatiles, which could be exceedingly important Industrially and biospherically.

Helium-3, if ever fusion based on this isotope becomes a near-term reality, is to be found virtually everywhere, but seems to be especially concentrated in ilmenite rich mare areas.

It seems that for a really successful industrialization, one as self-reliant as possible (some imports will be needed), we will have to set up shop in several locations, and, yes, that includes at least one of the poles, the north pole being the most promising on at least three counts: twice as much hydrogen (implying) water as at the south pole, more water-ice as opposed to frozen regolith with a low water content, and less than half the distance to the nearest mare coast, the north coast of Mare Frigoris. There is reason to start outposts on the farside as well, both industrial reasons, and scientific ones.

We should factor in locations that will be highly attractive to tourists. At first, any place that is “on the Moon” will do. But as tourism grows, the demand will grow for especially scenic areas, and they abound. Some tourists will be content to land, look around, and leave. But more and more the demand for overland excursions will grow strong. New tourist targets will at first be handy to new industry-focused settlements. But in time, we will see them sprout up in non-

settled areas. Different locations will offer different recreational opportunities as well as changes of scenery.

Now precisely because sites with special mineral resources will produce different products, they may also give rise to different arts and crafts, not just for frontier settlement enrichment, but to spur trade between settlements as well as to become more attractive to tourists, both those from Earth, and those from other lunar settlements – pioneers who need a vacation and change of scenery!

On Earth, trade was essential both for the development of local economies, and for slowly bringing all parts of the world into mutual contact. If we look back in history, trade has been absolutely essential, and probably the greatest single stimulus to the development and evolution of material cultures. Trade created incentives to build new highways, to improve transportation vehicles, to open new areas.



Above is a map I found online of trade routes through Asia that have been key to the development of civilization.

What has all this to do with where we are now? A lot! The Bush–NASA plan was to open an outpost. Yes, NASA has always been aware of the potential for more, but it has not been tasked by the government to explore and develop those options. Thus the NASA plan was designed for a “low flight rate” transportation system in which cost was not an object, virtually guaranteeing that a first lunar outpost would remain the sole one, and that it might not even become truly permanent.

Personally, I have been greatly encouraged by the change in direction. While the government–focus may no longer be on the Moon, the technologies now to get attention will lead to better, cheaper, more efficient transportation systems, with considerable commercial participation, and even leadership. Now this is what we need to truly open a frontier. “A” lunar “outpost” has never been the goal of The Moon Society, nor of the National Space Society for that matter.

Yet there are many enthusiasts, who (a) would settle for a token outpost, and/or (b) are not confident of the abilities of the commercial and private sector to open the lunar frontiers. Face it. NASA cannot and will not open the Moon. Now we have a real chance that this will happen, and maybe even sooner.

PK

MMM #257 AUGUST 2012

The Critical Path to "Pioneering the Moon"

1, The Situation

By Peter Kokh

Currently, some of us in the Moon Society and in the National Space Society are working hard to get more people aboard a path that will break the current log jam – the logs being different visions of our future in space, each with its own set of horse–blindness.

To this end, Board member Al Anzaldúa and I have spent many hours working on a plan to promote priority development of the technologies needed in common to return to the Moon, to mount a manned mission to Mars, and to prospect the asteroids. This is the “**Triway to**

Space” plan and Declaration, published in MMM #256 and online, in **Space Review**; <http://www.thespacereview.com/article/2078/1>

Also to this end, a number of us are working with John Strickland of NSS–Austin to mature a **Cis–Lunar Transport Plan** that will better, and more economically work to open the Moon, Mars, and Asteroids.

We all recognize the shortcomings in NASA’s vision and goals, encumbered as they are by the inanities of the political process. But these efforts, as timely and revolutionary as they are, are not enough to those of us who share the core vision of the Moon Society, “accelerating the day when there will be civilian settlements on the Moon, making use of local resources through private enterprise both to support the pioneers themselves and to help alleviate Earth’s stubborn energy and environmental problems.”

From: http://www.moonsociety.org/about/vision_mission.html – a document worth reading in full!

It is not enough to return to the Moon “to stay.” “Stay” to do what? Build an outpost that overtime will be as busy with exploration activities as McMurdo Sound station in Antarctica? Many would settle for that several decades out. Yes we want to fully explore the Moon, deploy telescopes that can better explore the universe, including radio telescopes on the farside – the only place in our solar system where we can be shielded from the growing radio noise cacophony that comes from Earth. Yes to build a fuel production station at one of the Moon’s poles to fuel our ships to go anywhere and do anything, especially to build the “Cis–Lunar Economy.”

But to some of us, that is not enough. Our goal is to extend the human frontier to the “Eighth continent,” not in the manner in which we have been doing on the 7th continent, Antarctica, but as we have done on the five other “new continents” since humanity’s “Out of Africa” Epic began before our current memories and legends. Our goal is to transform the Moon into a “human world.” Sorry, but fuel stations in the polar icefields, does not quite do that.

The Moon Society is pushing this first opening of course, as it must, as it should. But we should not kid ourselves that or mission stops here.

What is needed to “Settle” the Moon

Because of the high cost of imports – even with transports burning liquid oxygen and hydrogen produced from lunar polar ice and brought up to fuel stations at L1 and in Low Earth Orbit – to expand operations on the Moon, we must be able to produce the great mass of items we need to expand our habitats and operations from materials produced on the Moon. In Situ Resource Utilization or ISRU (“on location” for those who do not need to show how erudite we are by using Latin phrases) has to concern itself with more than producing liquid oxygen and liquid hydrogen and drinking water.

We have to learn how to build and manufacture the heaviest in gross mass (number of items times mass each) that we will need – i.e building and manufacturing materials – from the elements in moondust or regolith. More on that below.

Now anything lunan pioneers make for themselves, can be exported elsewhere “in space” at less cost than similar items made on Earth. Products manufactured on the Moon will furnish space hotels and other stations in Low Earth Orbit, Geosynchronous Earth Orbit and elsewhere in cis–lunar space, earning income for the lunar settlements. Read more: http://www.moonsociety.org/publications/mmm_papers/muscle_paper.htm

In the next article, we will discuss what building and manufacturing materials are most realistic and most promising. “ISRU” research has to prioritize those materials if we are serious about making settlements in which pioneers can feel “at home” on the Moon. These materials will also build more outposts used just for science and exploration. So if you are one who feels anything more is unrealistic, you still owe it to yourself to see that these ISRU goals are prioritized.

Where to live on the Moon:

Most serious (not science–fantasy) habitat/outpost designs circulated through recent decades confine personnel to cramped interiors very much as submarines and sea–floor

outposts do. That is tolerable for short tours of duty. Submariners commonly spend six months under water, totally withdrawn from the “world” as they have always known and experienced it.

But if we are talking not just about persons on temporary tours of duty, but about “pioneer settlers” who intend to stick it out long term, and if things go well, live out the rest of their lives on this new world, even raising families, complexes of habitat modules do not do it. Rather, we must learn in various ways, approaching the daunting task from both ends, how to marry our frontier settlements with the barren, airless, radiation-washed Moon itself. And those who can’t see how we could ever do that are part of the problem.

Now many readers may be familiar with Robert A. Heinlein’s classic science fiction novel, “The Moon is a Harsh Mistress.” Heinlein envisioned cities on the Moon, housed in complexes of tunnels carved out of the bedrock. That was the most realistic vision for some time.

Now that we know that the lava sheets of the lunar maria (the dark blotches on the side of the Moon that always faces Earth) must be laced with networks of lava tubes of considerable size, we know that at least in those areas, our “tunnels” are waiting for us. We have now discovered a number of lavatube skylights, and may in time learn how to read surface clues well enough to map some of these networks.

But there are no lavatubes in the highlands, and it is important to keep in mind that both lune poles are in highland areas. In fact, the closest mare areas to the south pole are 1,400 miles or so to the north (Humorum, Nectaris, Australe, etc.) The north pole is more blessed, with the northern “shore” of Mare Frigoris some 600 miles distant. Now some imagine pressurizing and “terraforming” these vast subsurface tubes, but that again, is a flight of science-fancy. The Moon is rich in oxygen but very, very stingy in Nitrogen, which is the very important buffer gas that makes up 4/5th of Earth’s atmosphere. In short, pressurizing a sub surface lavatube is for now “science fiction” of the “way-off” kind. We will settle lavatubes but in the same general type of pressurized modular structures that we would elsewhere cover with a blanket of moondust out on the surface.

Some envision large cities on the surface, very much like cities on Earth, but protected from the life-squelching lunar environment by immense transparent domes made of “unobtainium.” We say that, because while small domes of a few yards or meters in diameter might work (but fail to protect dwellers from radiation), much larger domes would be blown off the surface by the pressures they were trying to contain. The dome city would work only on a world with an atmosphere not too different than in pressure, from the Earth-like atmosphere inside, but of unbreathable composition. For example on Mars – if Mars atmosphere could be thickened substantially.

But how do we make our settlements any more livable than submarines! That is the challenge, and happily, there are lots of ways to meet that challenge and then some.

Explorers and scientist are paid. How will Settlers earn their keep?

We’ve already given the major part of the answer: anything settlers make for themselves, big or small, simple or complex, be it building materials, modules, machine parts, – or even food! – they will be able to market in LEO, GEO, stations at L1, and other cis-lunar locations – at a cost advantage over items made or produced on the Earth’s surface. Why? Because it takes only 1/23rd the amount of fuel to ship something “down the gravity well” than “up the gravity well” from Earth’s surface. The Moon’s 1/6th gravity is perhaps its greatest asset. And it will be some time, if ever, before fuel costs are too low to make a difference.

All articles in past issues of Moon Miners’ Manifesto (the first 25 years) which have a direct or indirect bearing on the Lunar Economy have now been released in an MMM Theme Issue: the Lunar Economy, available as a free download PDF file:

http://www.moonsociety.org/publications/mmm_themes/mmmt_LunarEconomy.pdf

So How will Pioneers come to “feel at home” on the Moon?

We have pointed out that they must live underground to be shielded from cosmic radiation and solar flares. But this can be in tunnels, lavatubes or out on the surface but covered with a blanket of moondust on the order of 5–6 yards~meters thick. If you stop and think, that is how we on Earth are protected from radiation. Yes, we live under the shield of the

Van Allen Belts created by Earth's strong magnetosphere. But our thick atmosphere protects us as well. If it were to get cold enough here on Earth to freeze the oxygen and nitrogen in the atmosphere, everything would be covered by an "analogous blanket" of nitrogen-oxygen snow!

Now this does not answer question of getting to feel at home, becoming comfortable with the forbidding lunar environment as a friend, not an enemy. That we will take up in the third article.

Note that we have already talked about making building materials and other products out of the elements present in moon dust. That in itself is part of the answer! That the Moon furnishes us with these materials already makes this barren world "friendly!"

2. Making Building and Manufacturing Materials from Moon dust

Glass-Glass Composites

When I launched Moon Miners' Manifesto, seminal initial experiments with "glass-glass composites" was underway under the aegis of the Space Studies Institute, then headquartered in Princeton, New Jersey. The holy grail was to see if we could produce glass fibers with a high melting point to imbed in a matrix of a glass with a much lower melting point. Experiments funded in part by SSI using lead as a dopant to lower the matrix glass melting point produced promising results. That was in 1937, and not much progress has been made since, for lack of funding. We proposed a business plan that might finance continued experiments that would produce a product marketable here on Earth, with the idea that by the time we got to the Moon, we would have plenty of experience with a close analog of the technology needed on the Moon. We suggested replacing lead (which would have to be imported) with lunar sodium and/or potassium, abundant enough.

http://www.moonsociety.org/publications/mmm_papers/glass_composites_paper.htm

Of course, no one took up on this, and nothing happened. But the feeling was common that glass-glass composites could be used to make many useful things from parts for Solar Power Satellites to lunar homestead furniture and perhaps even pressurizable habitat modules.

Cast Basalt Products

Meanwhile, some time back I had learned about cast basalt products, such as abrasion-resistant tiles and abrasion-resistant pipes: just what we needed to handle moon dust which is very abrasive. Indeed. It seems so very vital that we launch the first industrial complex on the Moon in a basalt-rich mare area for this very reason, that it seemed to be suicide to start setting up shop at the poles, as important as water and its components may be.

Cast basalt pipes and sluices and other objects needed to handle moon dust in an industrial operation would not be the only prize. Cast basalt could be used for floor and wall tiles, for table tops, for watertight planters needed to begin lunar agriculture, and for much much more. A basalt industry seems essential.

Lunar Alloys of Iron, Titanium, Aluminum, and Magnesium

These are the four "engineering metals" all present in sufficient abundance in moon dust, iron fines being everywhere, but more abundant in the maria, along with titanium, and with aluminum and magnesium being more abundant in the highlands. The catch is none of these "engineering metals" in pure form is of much use. We have found ways to alloy all of them to improve their performance. The trick is that the preferred alloy ingredients are not handily abundant on the Moon. We have to test "second best" formulations. Some of these have been tried on Earth but never put in production because we had better alternatives.

My #1 Brainstorming side-kick for some twelve years now, has been Dave Dietzler, of Moon Society St. Louis. Not afraid to go down a blind alley, Dave has found some promising options, such as "maraging steel" and these have been the subject of several recent articles.

Basalt fiber products

Meanwhile, I had stumbled on an article about about a basalt fiber industry in Northwestern India (Gujarat if I remember correctly) and between Dave and I we are learning what a motherlode jackpot of technology this is. Rebar used to strengthen concrete can no

longer compete with “rockbar” made out of basalt fibers. The latter are water resistant (won’t rust), stress resistant, less subject to thermal expansion and contraction.

We are now wondering what else this new wonder material could be used for: rails for lunar trains? Shells of habitat modules? This is a simple material abundant in the lunar maria, which can be put to a host of uses: parts for Solar Power arrays included.

In contrast, no lunar-glass or lunar-metal alloy seems as “ready to hit the market” as cast basalt and basalt fiber products. Just don’t look for basalt anywhere near the lunar poles! **So here is where ISRU should concentrate: in the Moon’s maria.** Note: If we dig trenches to inset our modules, the basalt at the bottom of the trench will be more concentrated.

Basalt fibers could be used to make “sandbags” for deploying moondust over a habitat in a “removable manner. It could make tarps and matts and so much more.

At any rate, beyond oxygen production, development of **easily produced and widely useful lunar building and manufacturing materials must have priority** – priority now, not a decade after we return. Cast basalt, glass composite, lunar producible alloys all need attention that they have not been getting. This is what we must mean by “ISRU.” What we now mean by it makes the users of this “secret code” term look shortsighted.

As we suggested in the Glass-Glass Composites paper referenced above, the place to start, with further development of the potential of basalt fiber, for example, is to find as yet unexplored but potentially profitable terrestrial uses, and then develop new products accordingly. The result is a process we have called **“spin-up” (as opposed to “spin-off”) – putting a close analog of a technology we will need on the Moon, “on the shelf” ready to use when we get there.** Some could get rich doing this!

3. Incorporating an Earth-like "Outdoors" in Middoor Spaces

A Eureka Moment

Moon Miners’ Manifesto saw the light of day in December 1986 only because of a “Eureka Moment” I had experienced a year and a half earlier in May 1985. You can/should (if you want to understand) read about this in http://www.moonsociety.org/chapters/milwaukee/mmm/mmm_1.html

In short, a visit to a most unique and original underground home 20-some miles NW of Milwaukee convinced me, that though, as Heinlein predicted, we might have to borrow into the Moon to live safely, we could “bring the views and the sunshine down with us.” While we had to be tucked under a moondust blanket one way or the other, that did not mean a disconnect with the best that the lunar surface has to offer: views of the landscape, and sunshine. Sunshine suggested house plants and vegetation-refreshed air, as well as food. Someone will reengineer my “Z-view” periscopic windows and other features, but they are too superior to a TV screen to ignore.

Beyond a network of “indoors only” habitat and activity modules

The first starter outposts will be but a complex of modules some inline, other off T and X junctions. But eventually hallway and even pressurized street networks will arise. And with that comes opportunity. Even individual modules can have “house plants” even “living walls” (Wikipedia “Green Walls”) to refreshen the air and assist in treating toilet wastes. If a modular biospherics plan is adopted to mate with modular architectures, then the capacity to refresh water and air will grow apace with the complex proper, minimizing what part of these processes has to be taken care of by central facilities. Halls can be lined with plants in the form of living walls, for example.

When the complex grow to the point that travel from one part to the other makes electric vehicles most welcome, then “streets” will emerge. These too can contribute to the biomass needed to sustain a self-refreshing atmosphere. While “room temperature” will be maintained in habitat and activity modules, there is no reason not to let temperatures vary –

within reason – as the 14.75 day long dayspan with continual sunshine passes and then rotates with the equally long nightspan.

The result is that we have a buffer, temperature– and climate–wise between the “indoors” and the “middoors” – an environment more reminiscent of the outdoors back on Earth. Forget about Heinlein’s tunnels! Then if vehicles dock with outpost and settlement docks, so that passage between without spacesuits is possible, we have the start of a “virtual” global lunar pressurized Earthlike environment.

4. The Role of Indigenous Arts & Crafts;

The need for people everywhere to express themselves with local materials

Every time pioneers on Earth have left their familiar home country and ventured into places with different sets of easily available materials and plants and animals, they began to feel at more and more at home as they learned to build and adorn their homes out of things locally available. It will be no different on the Moon. Objects of cast and hewn (carved) basalt will be an early choice in much of the Moon’s nearside. But artists also have a keen eye for the hidden possibilities within every bit of “free” material including scavengable scrap and “junk.”

We have personally attempted to pioneer an analog of a lunar painting medium.

http://www.moonsociety.org/chapters/milwaukee/painting_exp.html

The pioneers will find them. Hand made or crafted objects in front of a window or on the surface outside will temper the lifeless and life–squelching lunar surface with things made by human hands. Slowly, both from inside and outside, human spaces and settlements will begin to belong to the moonscapes, and vice versa.

5. The Role of "Lee–Vac" and "Out–Vac" Activities

A Contrast of Visions: “horse–blindered” verses “eyes wide open”

Perhaps most persons interested in opening the Moon only see small isolated outposts where persons clearly out of their element will do their best to put up with unearthly conditions for a tour of duty or two. The vision we have sketched of a quite more developed and satisfying frontier may seem science–fiction/fantasy to many, but this vision is grounded not only in the realities of the Moon and its features and makeup, but also in the capacities and drives that are characteristic of human pioneers. Were it not so, we’d still be found only in Africa.

The human epic has been an “intercontinental” one. The Moon is another kind of continent (as big as Africa and Australia together) across another kind of sea. This final “intercontinental” colonization will also be the inaugural “interplanetary” one. Do not judge the possibilities from the challenges new lands confront us with. Judge the possibilities from the unlimited capabilities to adapt which are part of the human makeup. We should never doubt that we have it in us. Those who would have us “stay home on Earth” are of the same ilk as those who would not dare leave Africa.

And this is just the beginning. To correct Genesis if I dare, **“Of stardust thou art, and to the Stars thou shalt return.”** We owe it to the Creative Agency behind our existence to realize all the capacities built into us. Not to do so would be the ultimate sin.

PK



Further Recommended Reading

http://www.moonsociety.org/publications/mmm_papers/muscle_paper.htm

http://www.moonsociety.org/publications/mmm_papers/outpost_trap.html

http://www.moonsociety.org/publications/mmm_papers/beyond_moonbase_1.pdf
http://www.moonsociety.org/publications/mmm_papers/pioneer-mental-health.html
http://www.moonsociety.org/publications/mmm_themes/mmmEden_on_Luna1.pdf
http://www.moonsociety.org/publications/mmm_themes/mmmEden_on_Luna2.pdf
http://www.moonsociety.org/publications/mmm_themes/mmmArts_Crafts.pdf

ANNEX

“Mother Earth” & “Father Sky” – The Duality of the Human Environment

By Peter Kokh – kokhmmm@aol.com

Expanded from an article previously published in the July 2008 issue of the SGAC Newsletter
http://www.spacegeneration.org/newsletter/SGAC-Newsletter-Jul08_opt.pdf

The number of serious problems confronting the world at large today continues to grow, and become ever more difficult to manage with each passing day. The human race seems to be having a full-scale adolescent style crisis. If we do not soon emerge in fair shape, we may face something much worse than a worldwide depression -- a new Dark Ages. How long that would last and to what depths we might sink, dragging our host biosphere with us, cannot be known.

Population growth is outstripping our ability to access available resources at the standard of living levels with which we in the Developed World have become all too comfortable. Maintaining energy use at customary levels and maintaining the present state of “health” of the environment are beginning to look like either-or choices.

Poverty is on the rise in many areas, even in First World Nations. There is no end to a list of pressing top level concerns. Solutions requiring investment in one area, make investment in other areas harder to support. Are we caught in an “end of times” downward spiral?

I think we need to take a look at just who we are, just where we came from, how we fit into the scheme of things as a people. If we can get a better insight into these things, we will have made a big step in putting the problems in the right context to begin to see solutions.

Most people consider our planet to be the only context in which we can understand our origins, our present history, and our future. One hears remarks such as “we need to find solutions to terrestrial problems right here on our home world, not out there somewhere.” Well, quite frankly, it’s too late for that. Our “home world” was Africa, and modern man has been on the move to wherever our developing technology would take us for at least 80,000 years. Our world used to be flat, but now we all consider it global. While few realize it, when man first set footsteps on another world, the “world” as a continuum of human horizons shattered that global limit forever; with that first step we became children of the Sun.

On every new frontier, we faced a new set of resources, of food sources, of climate conditions, of life-threatening dangers. Each time our great resourcefulness earned us the comfort of becoming “at home” in previously unforgiving, danger-fraught alien territory.

Backup a few steps to the real "Genesis." Of all the various elements of which our bodies are composed, only hydrogen is primeval. [Primeval helium is not found in living tissues, biochemical molecules, and substances.] All the higher elements have been forged in the interiors of stars which, at the end of their lifetimes, have exploded as “novas” scattering their enriched debris throughout the universe. It is from such “salted” gas and dust clouds that new stars began to form with attendant rocky worlds.

Genesis has it only half right. It should read,
“Of stardust thou art, And to the stars thou shalt return.”

Too many people think of Mother Earth alone. But where would we be without the Sun's light and warmth! Where would the Sun be without the countless older larger stars that ended their lives in a life-giving explosion? The Sun is but the most locally prominent part of Father Sky. Mother Earth and Father Sky are an inseparable pair. Together they constitute the holistic human environment. Without both, our existence and subsistence would be

unthinkable. Nor can it be understood, preserved, enhanced, have a trans-adolescent future. We are children not just of Earth, not just of the Solar System, but of the Universe. "Mother Nature" is more comprehensive than "Mother Earth."

In that context, the suggestion that all solutions to our problems must be found here on Earth is not only wrong, but ignorant, stupid, self-defeating. Frankly, it is doctrinaire smelling of "orthodoxy."

Looking outward, the Moon shares Earth's orbit about the Sun. It is ours, a hinterland continent with resources for us to access and use. It is Earth's "pantry."

Yes, we have major energy, environmental, and social problems, all complexly interlinked. If accessing resources from space can help in any useful way in dealing with these crises, then assertions that we should look beneath our feet for all solutions becomes a cult of ignorance. And beyond the Moon are other resource-rich bodies, the asteroids, comets, and everything else in our Sun's considerable family.

Now the Environment seen as Earth alone, is clearly susceptible to the exponentially increasing effects of inhabitation by an excreting technological species. But what about the Environment seen as including "Father Sky?" The Solar System is, by terrestrial standards, very vast. Is it possible that we could in any sense pollute that larger ecosphere? Perhaps. Extensive use of mass drivers used to move small bodies such as asteroids, if the exit velocity were to be within a certain velocity range, could create small, limited but dangerous streams of pressure vessel-rupturing shot. Our possible negative effects on the solar environment are, however, hard to assess at this time. Let us hope our successors will be on alert.

On the positive side, Earth Life will accompany us as we spread the continuum of our presence beyond Earth's atmosphere. Sure, we could process some sort of Solvent Green nutrient to make it unnecessary to bring with us sustaining plant life. I will be most happy to have lived out my life in this "more primitive" age in such a case. The oasis of life that sustains us, is not something to be outgrown.

Do we share the Universe?

Looking out further, while the Moon seems to be barren, sterile, Mars may or may not be. But at best, any Martian life is stunted at a very low rung up the ladder of life. Around Jupiter, Europa's extensive ice covered global ocean hides mysteries about which we can as yet only wonder. The same may be so for other ice-covered moons of Jupiter and Saturn.

We know of advanced multicellular structured life forms only here on Earth. Are we alone? As mammals? as intelligent environment-modifying creatures? Many easy, flippant answers display an incredible ignorance of how very vast the universe is, not only in space, but also in time. No matter how rare "other" fertile "earths" may be percentage wise -- e.g. "one in a billion" -- the universe is so vast that there must be hundreds, even thousands of billions of other civilizations throughout quadrillions of cubic light years and through the most recent two-thirds of the time since our universe seems to have come of age. That said, our nearest "contemporary" neighbor might lie beyond the distance in both space and time within which there could be any meaningful interaction or exchange.

At any rate, it is most likely that the Universe is multiply fertile on a grand scale.

Humans and the Universe?

"Go and fill the world" in this expanded sense, begins to take on an interstellar connotation. Technology may limit us to much less than that. Some worlds will be able to support native born flowerings of life such as has Earth. Others may be able to support the beginnings of life, but not allow it to get much further. Others still may have all the needed resources but not the environmental conditions. Some grand beginnings will occur on planets whose suns are too short-lived to allow the full flowering such as that has happened here on Earth.

And there perhaps is our ultimate Genesis mission: to sow life where it could not have arisen on its own; to advance life where local conditions have held its evolution in check; to speed up evolution where the local Sun may be too short-lived. See "Welcome-Mat Worlds", MMM #45, May 1991, reprinted in MMM Classic #5, pp. 25-28 -

at http://www.moonsociety.org/publications/mmm_classics/

It is not mankind that is called to return home to the stars, but Earthlife, Gaia herself. Earth-life cannot reproduce itself elsewhere on its own. Thus, with no apology to those whom the following makes them squeamish, an intelligent dominant species can be seen as the reproductive organ of its planetary Biosphere. Through us alone, can Earth-life, Gaia, Mother Earth spread beyond its current limits. Father Sky calls us to this pilgrimage home. It calls us to fulfill the destiny of Mother Earth, and in the process tap full endowments of the Mother Earth – Father Sky union, to save Mother Earth from the ill effects of our technological adolescence. Someday, when our civilization has become more adult, we will be Solarians, children of the Solar System.

As noted, our species is not originally “Terran” but African. We have been on an epic journey of expansion to one frontier after another. To stop now, in the belief that the world cannot be more than round, a belief as mistaken as the one that held the world to be flat, would be to turn our backs on ourselves, on our origins, on our destiny. We must not hide our light under the basket of Earth’s defining atmosphere. We must continue to develop the depths of our given talents. We can only do that by accepting the challenge to keep pioneering new frontiers. What other way to continue to give praise and glory to the creative forces which have forged us?

Those of us who want to look outwards for help with Earth’s intractable problems, are environ-mentalists too. But we see “environment” as a much larger bi-parental context. Our origin is on flat plains of Africa. Our destination is wherever our pilgrimage to keep on exploring our hidden given potential will take us. “Of Stardust thou art, to the Stars you shalt return.”

Mother Earth is not a spinster but wed to Father Sky. Her terrestrial brood is but the first. We must reject the demands for terrestrial solutions to terrestrial problems. We must educate others to the much vaster space-time context in which we have come into being, and within which our future lies. Our Environmentalism must be holistic to be effective. <MMM>

Starting a Dialog Between the Environmental & Space Communities

Peter Kokh – kokhmmm@aol.com 414-342-0705 December 23, 2007

PART I: CONSIDERATIONS IN DESIGNING A CONFERENCE

Part II will address Pre-conference actions and activities and

Part III, Conference structure and programming.

1. Conference Design involves a Philosophy

What follows are my thoughts as both a passionate environmentalist and a passionate space enthusiast, about the issues that should be addressed, and constructive actions we should take beforehand that will telegraph our sincerity to the environmentalist community.

I see the proposed conference as an opportunity to identify Individual, community, and global approaches to continuing environmental degradation in the atmosphere of “a Conversation” between the Environmental and Space Communities, both dedicated to the survival of our homeworld as a green paradise supporting our continued existence.

These considerations suggest a conference that includes instructive seminars and roll-up-the-sleeves workshops as well as presentations and panel discussions.

It is essential that we take the stance that our space-involving proposals will “solve assist” in mitigating environmental problems. To believe that we have “the” (i.e., total) solution is both naive, arrogant, and more importantly, demonstrably incorrect.

Foreword – a mutual love of our home planet and a mutual concern for the survival of humanity

Space enthusiasts have zeroed in on three ways to promote that survival

- 1) Use space resources (The Moon) to contribute to Earth's need for clean energy and to help slow and reverse environmental degradation through dirty energy generation methods
- 2) Protect Earth from a catastrophic asteroid impact
- 3) Plan the establishment of another viable exclave of humanity on another world (Mars) should we fail at one or both of the previous attempts.

Environmentalists are suspicious of (1) because of the way mining operators have wrecked local environments on Earth. We should have a presentation that shows how mining and settlement activities on the Moon would be quite different, and respectful of the Moon's natural beauty. In short, "our devotion to Mother Earth involves Father Sky."

Environmentalists stress changes in individual and community culture and near-term programs that reduce or slow the growth of the problem

Space enthusiasts have stressed national or international programs which might contribute long-range solutions.

TOPIC AREA #1: BIOSPHERICS

We too have a way to address the culture of the individual and local communities. Every future space frontier pioneer will have to be the ultimate dedicated environmentalist. Within Earth's enormous planetary biosphere with its seemingly bottomless atmospheric and oceanic sinks, we can get away with a lot of bad behavior because consequences are slow to become a problem.

In space frontier mini-biospheres, on the other hand, we will be living "immediately downwind and downstream of ourselves" and there our environmental sins will haunt us in very short order, not years later. Out of sheer necessity, space settlement pioneers will quickly evolve sustainable lifestyles. Charts and graphics about the very close water and air cycles will help. To the extent that we push Biosphere research, we will have the blessing of the environmentalist community.

The environmentalist community was keenly interested in the privately financed Biosphere II project. Our collective negative criticism of that project, our concentration on what was not achieved instead of what we learned, was not helpful. When all is sad and done, **"Nothing is a failure unless we fail to learn from it."** We collectively failed to put the best face on the results, which seemed to broadcast that self-sustaining mini-biospheres are impossible (and by inference, that settlements in space or on the Moon or Mars are impossible.)

In retrospect, a far-better choice would be to have come forward with suggestions for a second try, a third try, whatever it takes. We collectively showed that we did not have the right stuff. Environmentalists keep trying and trying until they get it right. If we are to deserve their respect, we have to do the same.

I suggest that much of our criticism was motivated by the same counterproductive "Not Invented Here" mentality of which we frequently accuse NASA.

Biospherics research legislative action item:

Congressional Budget restraints on NASA have forced the agency to abandon the goal of a permanently manned lunar outpost, substituting a permanent structure that would be intermittently occupied, not a situation that allows maintenance of a Biology-based Life Support System (BLSS) and so the agency summarily halted all further work and funds for its own BioPlex project in Houston, and for university programs such as NSCORT at Purdue. That there was not a whimper from the space activist community sends a signal that we are not really as interested in establishing settlement biospheres on the Moon or elsewhere as we pretend to be. We need to fix that, and lobby for restoration of BLSS research funds, and funds for a permanently manned outpost.

Lesson

Then we can talk to our Environmentalist friends of what all we will learn about living in a sustainable fashion with nature from our mini-biospheres within which we will have little room for environmental mischief. In such situations we will learn lessons on how to do it right

because it will be a short-term life-or-death matter. People stationed anywhere in space or on the Moon will essentially “live immediately downwind and downstream of themselves.”

Yes, we could learn those lessons on Earth, but we won't, because

- a) The experimentation is expensive and
- b) There is no immediate need.

We say we love our children and grandchildren but our economically motivated deeds give the lie to that.

Another lesson we will get across in this way is that we do not intend to go to the Moon and Mars with house plants. We intend to set up biospheres, mini-“Gaia-cules” if you will, in which to reencradle ourselves. Then we will be talking their language instead of talking over their heads.

Before we announce any conference, we should mount legislative activist campaigns, with considerable public fanfare, to restore NASA money for BLSS research, as well as funding for a permanently occupied outpost within 5 years of our first return.

Power storage technology

A major motive behind NASA's selection of a polar site for its first outpost is the desire to reduce the need for power storage to a minimum. But it should be implicit in the mandate that NASA establish a permanent moonbase, that NASA “open” the Moon. It cannot do this without biting the energy storage bullet. Doing so would give us the key to the lunar globe, not just to two very constricted polar ghettos from which there will be no escape until we do bite that bullet.

Legislative Action item:

NASA should be tasked with developing a full cycle (15 day capacity plus) lunar power storage system with backup (i.e. a first and second choice means, e.g., flywheels and fuel cells) and given the funds to do so. In general we should work to have the NASA outpost defined as a gateway, not as a dead end.

TOPIC AREA #2: GREENHOUSE GASES

1) Carbon Dioxide buildup – let's not argue about how much of the problem is geological and how much human. **We are contributing to the problem and it is only our contribution that we can do anything about.**

Not just fossil fuels but also fossil materials: We need to stop right now thinking that fossil fuels for vehicles and power plants are the major part of the problem. The use of fossil materials, such as limestone (calcium carbonate), is also a factor. Indeed, production of the number one construction material worldwide, namely Portland cement-based concrete, emits more CO₂ than any other human source. In the process we take limestone CaCO₃ and roast it to CaO (lime) and CO₂. Yes, some of this CO₂ is reabsorbed as the concrete cures.

CO₂ Retention: Destruction of CO₂ sinks

Even if geological (e.g., volcanic) sources contribute more CO₂ than fossil fuels and fossil materials, these latter sources are not the only way human activities that aggravate the problem. The problem is not only a matter of CO₂ production, but also of CO₂ retention in the atmosphere. Destruction of CO₂ sinks by deforestation and spreading desertification are significant factors in what is happening; Reforestation is a countermeasure, as are such community programs such as “green roofs” in Chicago's and New York City's high rise areas, and green driveways, where sod is protected from compaction and rutting by emplacement of an open grid-work sections made of high impact durable plastic. Reclamation of paved spaces by such means can help reestablish CO₂ sinks, as well as reduce rainfall runoff problems. Every little bit helps. Every improvement means that much more that is not part of the problem.

NASA Research & Development could probably help with this effort, as well as orbital monitoring not just of deforestation and desertification, but also of reforestation and re-greening efforts as well. We have to commit to legislative activism to expand NASA's budget to do so. Boasting about NASA's monitoring activities is not helpful. Everyone knows about it. Boasting about it serves no purpose other than to reinforce the suspicion that this is the only

good card in our hand. We need to identify other things and factors that NASA could monitor from space, and actively work to expand NASA's budget to do so.

WHAT WE THE SPACE COMMUNITY BRINGS TO THE TABLE

It is in not in our favor to appear that we are strictly a spokesman for NASA. It is in our interests to identify what NOAH can do, what DOE can do, and so on. NASA and NOAH: Nor should we rest on NASA's or NOAH's laurels! It behooves us to identify what NASA and NOAH could do and are not doing, and adopt legislative action programs to see that NASA and NOAH are fully funded to explore these options.

THE CONTRIBUTION OF ISRU R&D

I spoke of fossil materials being as big a part of the problem as fossil fuels. Here is where NASA R&D could help. This may seem a stretch, but I think not. Below are just two of many possibilities:

a) Glass-glass composites: Space Studies Institute (SSI) started research on glass-glass composites with a view to their use as a structural building material on the Moon. Research stopped with the testing of the first ice-cube sized sample with very promising results. If we could get either NASA or some enterprise to continue the research, the latter in the hopes of profitable near-term terrestrial applications, we would not only end up with a ready to go manufacturing, building and construction material for the Moon, but possibly with a substitute for wood furniture (case goods) and other building materials, reducing one of the drivers behind deforestation. (Forests are also being cut for replacement by agricultural land). Many countries are low on forests, rich on sand and rock powder. Glass composites could help them develop both a domestic and export economy.

b) Magnesium-based cements. Congress could provide incentives for NASA and/or industry to develop magnesium-based cements (what we used for many centuries before the development of Portland cement out of limestone) to the point where Magnesium-cements becomes as serviceable as Calcium-cements for a growing number of construction needs. Meanwhile, we would have one more ISRU technology ready to use on the Moon and Mars. The lunar regolith is 8% Calcium and 6% Magnesium by composition, so both are viable options. Dr. T. D. Lin has already demonstrated the production of lunar concrete using lunar calcium. To be gained is a reduction in the production of greenhouse gases from fossil materials.

Again, if we actively took the lead in promoting these lines of research, we would gain considerable respectability from the environmental community, as well as setting ourselves up for the establishment of resource-using industrial settlements on the Moon, to help provide building materials for solar power satellites, among other things

SPACE-BASED SOLAR POWER

I notice a tendency to equate SBSP with SPS. SBSP should include Criswell's Lunar Soar Array system. Should we be in the business of picking technology winners? Or should we work to enable either?

An especially tasked SPS Design Workshop

A Solar Power Satellite system alarms many in the environmentalist community, particularly astronomers (professional and amateur alike), who cringe at the thought of the celestial ecliptic becoming as studded as a biker's belt with SPS units each as bright as Venus. It would be to our advantage, and gain us respect, if our conference included the first of a series of design workshops and competitions to come up with SPS architectures which minimized reflection of sunlight (as opposed to microwave energy) back to Earth, without significant weight penalties. I suggest that such a workshop be part of our conference and that this topic be part of the Call for Papers.

Vested Interests: an obstacle not to be dismissed. Quite separate from power beaming issues which are certain to worry many, is the idea of generating power in space "to replace" fossil fuel use (oil, gas, coal, tar) for power generation. The vested interests are strong and have much more money to spend on lobbying than we do. They will see SBSP as a threat.

A World Wide Orbital Grid (WLOG)

Here is a suggestion that has two principal advantages:

- 1) It will be in the interests of the fossil fuel industry to support it
- 2) It will serve as a platform for either SPS or Criswell's Lunar Solar Array system, allowing us to postpone a technology choice without postponing the final deployment of a complete system.

This suggestion is a **World Wide Orbital Grid** consisting of platforms in GEO that are composed of rectennas to receive excess power beamed up from the surface and transmitters to beam that power directly (or indirectly by relay through another WWOG unit) to other locations around the globe. Such a system would prove and debug power beaming and remove it as an issue, separately from the issue of visual pollution in the ecliptic. It would take less mass to erect and could be erected in phases. While a WWOG would not increase the total amount of power generated per se, it would:

- a) Even out distribution,
- b) Lower the average price of peak power
- c) Level the economic playing field between nations and continents,
- d) And thus buy us time.

However, it could increase clean power generation as well by creating a market for solar and wind power in under-populated desert areas for beaming to other areas of the world as needed. Saharan nations, for example, might enjoy an economic boom as latter day Saudi Arabias. Wind power could also be harnessed on a trial basis from rocky areas of the Antarctic coast. In short, a WWOG opens many options, leads equally well to either an SPS or LSA system, negotiates opposition, and buys time.

I'd like to present this WWOG option, possibly with Madhu Thangavelu who independently came up with a similar proposal. We should, of course, present the SPS option, the LSA option, and He3 options.

Either way we win and do not come off as involved in one particular option for reasons of self-interest. Rather we have shown ourselves to be sincerely looking for solutions. But if instead we go in focused on a single program, we will appear to be close minded, and even ignorant, in so much as we seem to believe that the problem is simple and therefore so is the solution, when neither is the case.

One thing I think we should avoid is a battle over numbers: "my solution solves 60% of the problem while yours, since it only addresses 15% of the problem is therefore worthless." This should not be about finding numbers with which to squelch those approaching the problem from other directions.

On the one hand, we should graciously admit that space-based solutions will take time and that therefore individual, community, and other non-global approaches are invaluable in reducing interim growth of the problem.

On the other hand, the Environmental Community needs to be so gracious as to admit that while individual and community action is vital, that the problem is bigger than that, and that global approaches have their role to play. We can only expect that concession from them, if we make the prior concession in respect to their efforts. The world's future is the concern of both communities.

PART II PRE-CONFERENCE ACTIVITIES SUMMARY

LEGISLATIVE ACTIVISM:

- a) Restore NASA funding for BLSS (Biological Life Support System) research
- b) Integrate BLSS in Lunar Architecture by mandating NASA to advance to permanent outpost occupancy within 5 years of first manned return
- c) Mandate and fund NASA to develop a go-anywhere lunar power storage system
- d) Funding for NASA to continue SSI glass-glass composites R&D to advance it to a high state of readiness as a versatile lunar building material as well as for terrestrial applications.

- e) Funding for NASA to begin magnesium cement upgrade technologies R&D for both terrestrial and lunar application.
- f) Identify orbital monitoring/mapping tasks for both NASA and NOAA and work to increase NASA and NOAA funding accordingly in all areas relevant to the ever-changing state of the environment.
- g) Continue to push the NSSO report and its recommendations for an inorbit demonstration project.
- h) Work in advance of the conference to expand SSAFE [the Space Solar Alliance for Future Energy] to international partners.

THE LESSON FOR US: addressing concerns of the Environmental Community will greatly advance our own goal of establishing Space Settlements.

PART III: CONFERENCE STRUCTURE, FEATURES, THEMES

Call for Papers

I think that the Call for Papers is vital. It should include all the things we have identified above, plus any topics and investigation areas our environmental cosponsor(s), if we can find one, will want to add.

- Clean Energy Production with Reduced CO2 Emissions
- Ground-based solar
- Photovoltaic
- Large-scale solar thermal
- Wind
- Geothermal
- Other
- Making the most of Available Energy Supplies
- NASA R&D on energy storage for Peak Demand
- DOE/NASA development of a World Wide Energy Grid
- Non-Fuel Problem Areas
- Fossil Materials – Limestone-based cement
- NASA/Industry Upgrading of Magnesium-cement technologies
- Reestablishing CO2 sinks
- Slowing Deforestation & Desertification
- Development of glass composite wood substitutes
- Experimental Wind barriers
- Reforestation
- Re-greening low traffic paved areas
- Sustainable Lifestyle Research
- Renewed NASA BLSS / Biospheric Research
- Earth-based grass roots sustainable lifestyle research
- Future Technologies using new abundant clean energy sources
- Reclamation of deserts with desalinated seawater
- Production of clean drinking water by the same means
- Space-Based Energy Options from Earth's hinterland
- Solar Power Satellites
- Workshop on SPS low albedo design options
- Lunar Solar Arrays and Relay Satellites
- Lunar Helium-3 for future 2nd generation Fusion plants

WORKSHOP IDEAS

- Low reflectivity Solar Power Satellite design
- Go-anywhere lunar power storage systems
- Business Plan for a Glass Glass Composites Industry

- Design of a World Wide Orbital Power Beaming Grid

INSTRUCTIVE SEMINARS by us

- The NSSO Report
- Solar Power Satellites
- Lunar Solar Array
- Moon Mining: how, what, environmental issues

INSTRUCTIVE SEMINARS by the Various Environmental Sponsors

THEMES & CATCH PHRASES

“Mother Earth & Father Sky”

“Living Downwind & Downstream of Ourselves”

“Acting Locally, Thinking Globally”

THE PAYOFF

- a) We begin a constructive dialog with a natural ally who has long been suspicious of our motives and concerns
- b) We promote space-based solar power to a powerful constituency who otherwise would not give it much thought
- c) By addressing concerns of the Environmental Community through additional NASA research and a strengthened NASA mandate, we will greatly advance our own goal of establishing Space Settlements.
- d) Preparing and conducting this conference will expand and structure our activist activities in advance and for some time to come.

Peter Kokh – kokhmmm@aol.com 414-342-0705 December 23, 2007

SUPPLEMENT: FROM THE LUNA CITY YELLOW PAGES

Occasionally, we try to bring to life topics we are talking about and show the Private Enterprise Opportunities that could make them real. **PK**

Luna City Yellow Pages

To all of our MMM Readers

From MMM Editor, Peter Kokh

Many of you are relatively new to MMM, although there are a number who have been with us for all our sixteen plus years. In that span we have covered a lot of topics, many of them illustrating the possibilities for life on the lunar frontier. There are quite a few good past articles still worth reading, and unfortunately, for a number of reasons (all coming down to a lack of time on my part) only some of them are online. Readers with online access are encouraged to browse at:

<http://www.asi.org/mmm>

It occurred to me that I could reprint some of these articles. But then I decided on another way to recap many of the ideas and possibilities covered in these essays: publishing a column, a page, or pair of pages of the

Luna City Yellow Pages

in each future issue. So we start this issue. Enjoy the ride, or should I say, the "tour?"

-PK/MMM

Homestead Improvement Contractors

Sun MOODS, LLC.

Retrofit Lighting Systems Specialists

- Light Pipe Systems: Light port diffusers, shades, and dimming shutters. Stained glass, ceramic, and alloy. Cove lighting systems with cobalt blue glass diffusers for that sky blue hue on your ceiling vaults to combat those "black sky blues."

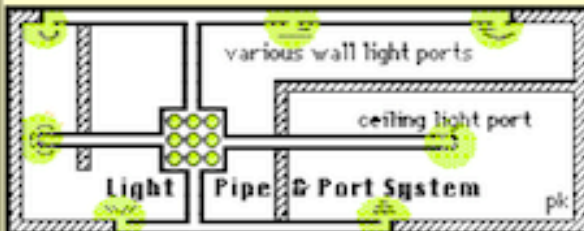

- Fiber Optic Systems for retrofit application as well as bundles up to 50 centimeters in diameter for incorporation into habitat module ceilings during their manufacture.
- Visit Our Showroom to see Luna City's biggest and most diverse selection of floor and table lamps, wall lamps and wall washers, and ceiling fixtures, and a selection of shades and diffusers.
127 Artemis Road East, 235-4448 (BE-LIGHT)

Now you can have
Beautiful Brick Walls
in your Homestead
by

LunaBrick

Recreate the rustic look of Old Earth with brick walls without mortar.

Our "bricks" use a unique interlocking shape similar to that of the NovaBrick mortarless brick siding product pioneered on Earth by Amcon Block [www.novabrick.com]

Our bricks have an interlocking shape that holds them securely in place without the use of mortar or adhesives.

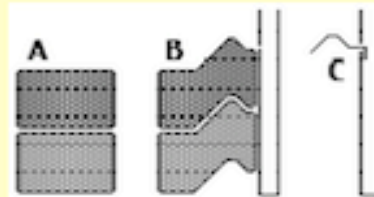

KEY: (A) Ordinary Brick Cross section
(B) LunaBrick Cross-section
(C) patented hanger clips into embedded hanger strips every 4th row, secure wall.

LunaBrick comes in **two color styles:**

- New Moon:** naturally variegated shades of light to dark gray - the colors of regolith. These moontone bricks are made from compacted mold-sintered regolith from which free iron fines have been removed.
- Old Earth:** naturally variegated rust shades made from compacted mold-sintered brick rich in free iron fines, then steam-rusted.

Purchase this fine product from our Factory Outlet Store in Luna City,
328 Tanstaaff Drive North,
344-6666 (DIG-MOON) or from
Homestead Depot in Shangri-Luna
and Port Tsiolkofsky

LUNA CITY YELLOW PAGES

Contractors, Out-Vac

Stand Proud Moon Rocks, LLC

**Moundscaping & Lithscaping
General Contractors & Suppliers**
*Make a Statement by letting us shape,
style, and/or tint your Shielding Mound*

TINTING DUSTS:

- limelighting (calcium oxide)
- blackening (ilmenite)
- rusting/ochering (iron oxide)

OTHER SURFACE ADDITIVES:

- moon glass spherules
- breccia aggregate, random or uniform
- various available shredded non-recyclables

HARDSCAPE COVERING:

- textured cast basalt slabs
- in situ fusing & glassification
- molded lunacrete & sintercrete

SHAPING & STYLING

- textured slab-banded terraces
- replacing piled regolith with bagged regolith, neatly stacked

OTHER SERVICES

- shielding removal for hull repair, remodeling, and/or additions
- embrassures (regolith retainers) for EVA locks
- ramada lean-to sheltered vacuum structures
- perimeter & EVA gateway matched moundlets

DIY EQUIPMENT RENTALS & MATERIALS

Serving Luna City District and Surroundings
13246 Perimeter Road – 234-0192

Out-Vac Signs, LLC

**Specializing in Durable Signs that are
Easy to See and Easy to Read
Under All Out-Vac Lighting Conditions**

- Our EZ-See Line signs are easy to see and easy to read in full sunlight or by nightspan-or shadow-piercing headlamps
- Our EZ-Shine Line signs use solar-powered batteries activated by vehicle proximity sensors set at 100, 200, or 500 meters
- We use colors and hues tested for high naked eye visibility and legibility against typical moonscape and black sky backgrounds.
- Our signs need no maintenance and are fully guaranteed for twenty years, and fully insured against meteorite impact destruction.

1630 Terra Nova Road – 567-0864

Contractors, Out-Vac, Cont.

Out-Vac Work Vacations

For the Price of an Out-Vac Tourist Excursion, You Can Spend 1-4 Weeks Working With Various Field Teams! Gain Experience & Help Build the Lunar Frontier! Openings Always Available!

- Prospecting
- Road & Railroad Construction
- Communications Relay Emplacement
- Lavatube Exploration

See our Ad under EXCURSIONS, WORKING
100 Central Parkway, Suite 237 – 342-8833
Email: workoutvac@lcnnet.lu

Arts, Performing

Moon Dreams School of Dance

Open Registration for all who feel the need to dance,
leap and twirl in our light gravity!

Beginners, Intermediate, Advanced Levels

Openings also for anyone

with Choreographic Experience

Help pioneer essentially all new dance art forms,
bursting limits of movement accepted on Earth!

- Neo-classic dance ("Ballet de Lune")
- Free form "modern" dance
- Lunar Ballroom
- Frontier line dancing (lunar country)

Small Group Classes at Convenient Times

Individual tutoring and in home instruction

Opportunities to Showcase Your Talents

- Community Access TV shows weekly on Ch.33
- Go on tour to other lunar settlements
- Telecast Performances for Earth Audiences

Studios at Alan Bean High School for the Arts

934 Bean Parkway # 350 – 271-1015

New Jamaica Steel Drums

Learn to play the steel drums!

Make your own steel drum instrument!

Students are guided in shaping and tuning their own
steel drum pans from salvaged steel drums used for
shipping chemicals from Earth

Played solo or in combos, steel drums or pans have a
delightful, cheery sound. Help bring this delightful
Caribbean spirit to the Lunar Frontier!

Regular competitions, recitals and tours
Abundant opportunities for street and park
performances on your own or with others.

Studios at Alan Bean High School for the Arts

934 Bean Parkway # 303 – 271-1017

LUNA CITY YELLOW PAGES

ART & CRAFT SUPPLIES

Born Again Hair

- Hair bought and sold
- Hair craft tools and supplies
- Hair Craft Books and Plans
- Hair Craft Courses
- Custom Hair Craft art objects created to order

Browse our Consignment Corner

- Hair Craft jewelry, appliques, wall art

268 Earhrise Lane (residence shop) - 255-4247

The Potter's Wheel

Learn the unique art of Lunar Ceramics

Claystuffs, Glazing Oxides, Kilns, Wheels, Molds

Learn to formulate your own Clay
Courses for Beginners, Advanced Classes
Individual Tutoring - Apprenticeships Available
How to Books and Plans Galore
99 Enterprise Center, Suite 17 - 708-8379

Settlement Dye Works

A growing list of natural, biodegradable dyes
for issue cotton and other vegetable fabrics

*We Dye for You!
Or Dye Yourself!*

Use our vats to dye your fabrics under supervision

We are a certified waste dye-water recycler
ULC School of Agriculture Registered

Visit our Facilities Soon to see what we can do for you.

2084 Harvest Road - 393-9757

Star of Luna

Jewelry making and supplies

- moonrock breccias, crude or precut & polished
- raw regolith glass spherules
- scrap metal: iron, aluminum, magnesium, titanium
- carveable hardwoods: apple, pear, cherry (all biosphere bank withdrawal fees prepaid) - learn to make wood jewelry and high-end knobs and handles for metal cabinets
- Jewelry Artcrafts books, tools
- Jewelry Making Courses & Instruction
- We also sell tools & plans for chain mail creations

Sell your creations in our Consignment Section!

99 Enterprise Center, Suite 28 - 539-3579

RECYCLING SERVICES

Born Again Hair (see our ad under Arts & Crafts)

Hair bought and sold, Hair craft supplies and plans
268 Earhrise Lane (residence shop) - 255-4247



*"Any Company's Waste can become
Raw Material for a New Enterprise"*

ENCYCLOBIN™ is a Computer Databank
Service of the University of Luna City [ULC]
School of Industry & Enterprise

- Mining and Processing Tailings sorted and characterized by elemental and mineral analysis
- Manufacturing scrap
- Chemical wastes sorted by chemical analysis
- Miscellaneous processing and manufacturing byproducts fully characterized and sorted
- Co-import salvage and dunnage
- Packaging and Shipping scrap and waste
- agricultural by products, waste biomass, and recycling residues
- Post-consumer materials characterized & sorted

Let us find the materials you need.

*Let us help you create an enterprise plan
on available scavenged materials*

ULC School of Industry & Enterprise
personnel offer free consulting and
business plan creation consultation

Low Royalty Fees

Make an appointment with our courteous staff
711 University Circle - 852-3492 (UCL-DIVE)

Second Life Fabrics

Scrap & used fabrics bought and sold
Fabric Art supplies & Consignment Fabric Craft Items
99 Enterprise Center, Suite 21 - 322-7127

Shantytown Import Stuffs

Scrap Metal - Scavengings - Tramp Art & Craft Materials
6700 Spaceport Road - 742-6897

Sort Rite, LLC.

Sortation Supplies & Management Software
303 Conrad Drive, Suite 33 - 707-8748

LUNA CITY YELLOW PAGES

NIGHTSPAN SERVICES

Power Storage Specialists -----

OVERNIGHTING, LLC

General Contractors for all types and brands of
nightspan power equipment & systems.
We specialize in

- Fuel Cells
- Hydroelectric loops
- Water or NaK Eutectic storage systems

visit us online at overnighting.com.lu
101 Sunset Drive - 786-7473

Potentiation, Inc.

General Contractors for all types and brands of
nightspan power equipment & systems.
We specialize in

- Small modular nuclear systems
- Magma Pools
- Flywheel systems

visit us online at potentiation.com.lu
201 Sunset Drive - 255-4247

Nightspan Scheduling Consultants -

MOONBeat

Let our Consulting Team your business manufacturing
operation for the most efficient scheduling of dayspan
and nightspan operations to save you the maximum
on your nightspan power bills.

visit us online at moonbeat.com.lu
155 Sunset Drive - 329-6483

PowerMates

Synergy Partnerships are our Business

Whether your operation is predominantly energy-
intensive or labor-intensive, let us find you the ideal
Dayspan or Nightspan Partner with which to pool your
work force, for around the sunth operations.

powermates.com.lu - 727-8637
175 Sunset Drive, Suite 300

Nightspan Lighting -----

N-Lights, LLC

Let us N-Lighten your home, business, or factory.
We design or redesign entire N-Lighting systems.
n-lights.com.lu - 654-4487

250 Sunset Drive

Nightspan Tour Operators -----

Angus Bay Shoreways Fleet (see our ad under
COACHES, CHARTER) - angusbayfleet.com.lu
25 Perimeter Road - 222-6224

Home of the Sunrise/Sunset Chasers Club (See ad
under CLUBS & ASSOCIATIONS) - ssc.org.lu - 747-3738

Gypsy Moon Charters

"The Moon is our Turf - we 'll take you anywhere!"

Earthlight tours & Nightspan Mare cruises
Total Eclipse ("Umbra") Excursions
Complete tour descriptions at gypsymoon.com.lu
38 Perimeter Road - 497-7966

Seven Seas Tours, LLC. - "Milky Way"
Nightspan Excursions into Farside are our specialty
sevenseas.com.lu - 645-5929 - 57 Perimeter Road

Nightspan Excursion Outfitters ---

The Earthlight Sportster

Outfitters for out-vac nightspan recreational activities
All the gear you need for personal or group outings

- Blacklight lamps and accessories
- Gear for Earthlight road rallies, Shadow Tag,
Lith-mobiling, Blacklight shadow prospecting
- IR goggles & special helmet visor screens
- Night-hardy moonsuits
- Field telescopes
- Die Hard™ Fuel Cells

earthlight-sportster.com.lu
333 Republic Avenue - 784-5483

Nightspan Gardening -----

The Earthlight Gardener - 427-3367

Nightspan Miscellaneous Services -

The Firefly Shop: Fire Chambers & Neon art
lighting our specialty. Big selection or made to order
715 Republic Ave. - 347-3359 - firefly.com.lu

Party Over Here! Lastnight & Firstmorn Party
Supplies & Planners - indoor, middoor, out-vac
partyoverhere.com.lu - 10 1st Alley - 327-2789

Luna City Sky Dome - Dance in the Earthlight
at the Sky Dome in Constitution Park. Open dancing
daily nightspan evenings. Private parties welcome.
skydomedancing.com.lu - 759-3663

LUNA CITY YELLOW PAGES

Help Wanted

The Lunar Infrastructure Development Corporation is seeking researchers for these and related positions described below for employment at the International Lunar Research Park. Must be willing to relocate to the Moon for a period of at least one year barring serious illness or injury.

CONTACT INFORMATION:

Lunar Infrastructure Development Corp.
Human Resources Department Office
PO Box 6666, St. Louis, MO 63101, USA
attn: David Dietzler, Recruitment Officer
US code +314.562.6666 work.moon@lidc.com

BIOLOGISTS AND ECOLOGISTS

Responsibilities include R&D related to CELSS and food production on the Moon. Background in permaculture and organic farming desired.

CIVIL ENGINEERS

Surveying, site improvement. Design, construction and maintenance of the physical natural Lunar environment, including works such as roads, bridges, tunnels, retaining walls, and buildings

CONSTRUCTION WORKERS

Experience in extreme environments such as the Antarctica, offshore drilling, Athabasca Tar Sands, Deep Mining, etc., will be an asset.

ENGINEERING TECHNICIANS

Electrical, electronic, mechanical, manufacturing, chemical, bio-tech, computer and robotics technicians to test, operate, perform routine maintenance, repair, assist in research labs and shops, and do light assembly and manufacturing are needed for groundside and lunar positions.

EXTRACTIVE METALLURGISTS

Responsibilities include R&D related to development of cost effective methods of producing oxygen, metals and other materials on the Moon. Development of chemical processes in addition to production of equipment for such using lunar on-site materials is emphasized. Metallurgists will also develop alloys using only lunar materials including rare earth elements and thorium.

COUPONS for Luna City Pizzeria on Page 3

MACHINISTS & FABRICATORS

Experience in making and/or modifying metal parts. Steel, gas metal, and gas tank arc-welding. Stereolithography and electron beam free-form fabrication (sbf3) experience desirable.

MANUFACTURING HARDWARE AND SOFTWARE ENGINEERS

Numerous openings for the dedicated individual willing to work on teams to develop the multitude of products needed on the Moon for survival and industrial expansion using only on-site materials with the latest 3D printing and computerized manufacturing equipment and robots. Knowledge of traditional manufacturing processes required.

ORGANIC CHEMISTS & CHEMICAL ENGINEERS

Responsibilities include R&D related to production of cost effective methods for synthesizing silicones and other synthetic materials from on-site lunar materials and development of equipment for the same using lunar materials. Lubrication engineering also to be researched.

PRESSURE ENGINEERS

Experience with boilers and other pressure vessels is helpful. Experience helpful in areas of design, manufacture and/or construction and maintenance of pressure seals of airlocks, habitat and other modules designed to hold breathable air pressure against an exterior vacuum

ROBOT TELEOPERATORS

Groundside and lunar positions available for experienced robot teleoperators with at least two years experience operating submarine and underground mining robots.

SKILLED TRADESMEN

Machinists, tool and die makers, welders, plumbers, pipe fitters and electricians willing to work in spacesuits as well as "shirt sleeve" environments on the Moon. We will provide free spacesuit training and hazardous duty pay for work in vacuum.

*On the Moon, as on the Earth,
You can rely on your friendly
YELLOW PAGES
For the assistance you need!*

About the Above Selection of Articles

Perhaps some of you may notice that the relevance of the articles above to how lunar pioneers will live on the Moon in a way that embodies the best of environmental principles has two main threads:

(1) Living downwind and downstream of ourselves:

Life in a restricted enclosed mini-biosphere with minimal air and water “sinks” will allow little room for careless behavior of the kind exhibited by even the most environmentally attuned terrestrials. The pioneers will of necessity have living in harmony within their “pockets” of “nature” foremost in mind, even above personal economics and comfort and convenience. The young will of necessity be taught these facts of life. Living accordingly secures their future as well.

(2) Using resources with maximum efficiency:

This will be necessary if they are going to beat the odds against achieving economic self-reliance. This does not mean the ability to produce all their needs. It means being able to produce enough of their own needs to significantly reduce the burden of very high cost imports, as well as being able to export enough to earn credits to pay for imports that cannot be avoided. Using lunar resources sparingly will involve industrial design standards that permits thorough recycling and avoiding cross contamination of unlike materials by adhesives and other disassembly-unfriendly methods.

Our hope it that the Pro-space reader will now become more environmentally aware, and that conversely, that the pro-environment reader will become more enlightened about the prospect for the ultimate in clean-green living on the Moon. Luna pioneers will teach us down here on Earth, the way.

It is a shame, that in general, environmentalists and space enthusiasts seem to be in two opposing armed camps. The truth is that **we all want the same thing: preservation of Mother Earth and of Humanity.** We just come at this goal from different directions. We owe it to ourselves, both parties, to find ways to collaborate and strengthen each other's activities and projects, and end the petty jabs.

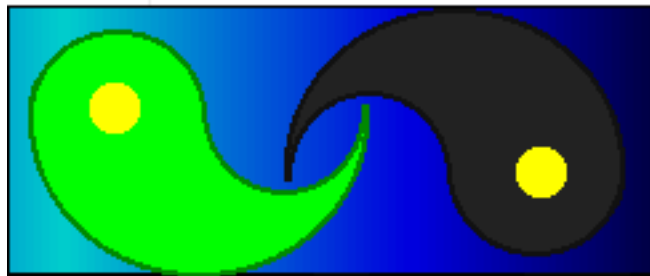

Mother Earth

Father Sky

Mother Earth and Father Sky! The Earth is not a self-sufficient island. It is part of a Solar System. Without the Sun, the Earth would be cold and dead and lifeless, if it existed at all. The Moon is the Earth's birth-mate so to speak, sharing Earth's orbit around the Sun. It is just another kind of continent across another kind of sea. And so too are the other planets, moons, asteroids, and comets of the Solar System sibling theaters for future human activity. But when all is said and done, Father Sky takes on a much grander context. Every atom in our bodies other than hydrogen was born in the core furnaces of stars that have already lived and died.

Genesis needs a rewrite: “Of Stardust thou art, and to the Stars thou shalt return!”
Should this not be our ultimate Pilgrimage? ---- PK



From Africa to the Moon, the Human Epic told in footprints, continues to the stars!

End of the Beginning